

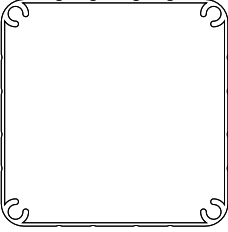

**Pricelist Pergola - Canopies**  
**Liste de prix Pergola - Auvents**

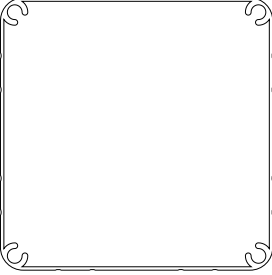
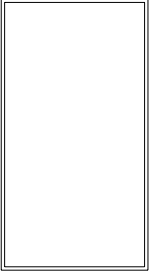
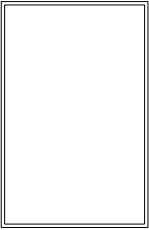
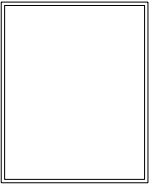

## **Traditional Pergola Profiles Profils de Pergola Traditionnelle**

Shape / Forme	Description	Code	Weight / Poids	Price / Prix
	Column Support 100x100mm Poteau 100x100mm	900	1891 gr/m	7,80 €/Kg
	Column Support 120x120mm Poteau 120x120mm	901	2819 gr/m	7,80 €/Kg
	Transom 120x65mm Traverse 120x65mm	59-026*	1474 gr/m	
	Transom 100x65mm Traverse 100x65mm	59-027*	1312 gr/m	
	Transom 80x65mm Traverse 80x65mm	59-028*	1150 gr/m	

**Accessories for traditional pergola**  
**Accessoires pour pergola traditionnelle**

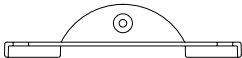
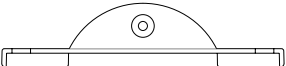
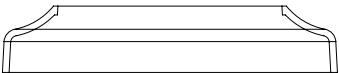
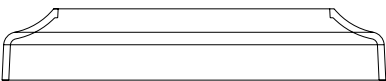
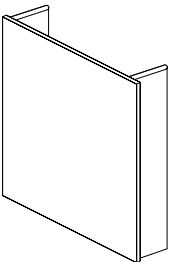
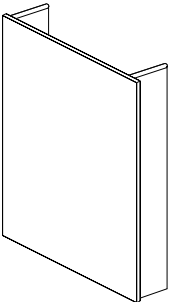
Shape / Forme	Description	Code	Price / Prix
	End cap for column 900 Embout de poteau 900	272-231	3,50 €/pc
	End cap for column 901 Embout de poteau 901	272-230	2,90 €/pc
	Support foot for column 900 Sabot de poteau 900	4104	10,50 €/pc
	Support foot for column 901 Sabot de poteau 901	4105	12,50 €/pc
	End cap for transom 59-028 Embout de traverse 59-028	272-213	3,20 €/pc
	End Cap For Transom 59-027 Embout de traverse 59-027	272-214	3,60 €/pc

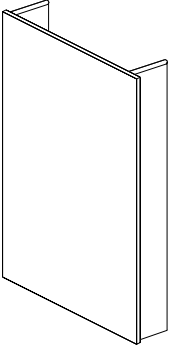
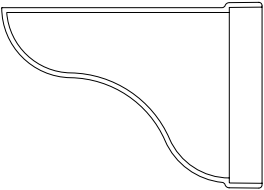
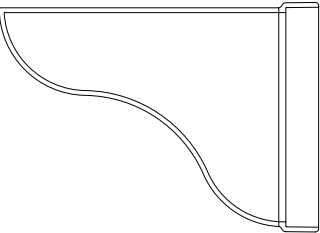
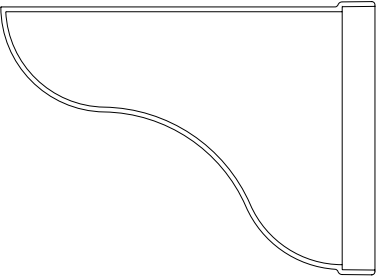
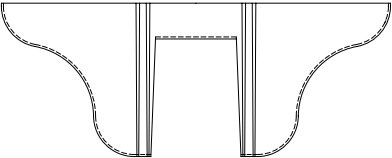
Shape / Forme	Description	Code	Price / Prix
	<p>End cap for transom 59-026 Embout de traverse 59-026</p>	272-215	3,80 €/pc
	<p>End cover for transom 59-028 Capuchon de traverse 59-028</p>	272-210	4,00 €/pc
	<p>End cover for transom 59-027 Capuchon de traverse 59-027</p>	272-211	5,30 €/pc
	<p>End cover for transom 59-026 Capuchon de traverse 59-026</p>	272-212	6,50 €/pc
	<p>Base support for column 900/901 Support base de poteau 900/901</p>	272-200	17,30 €/pc

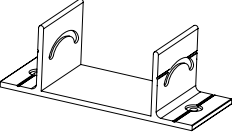
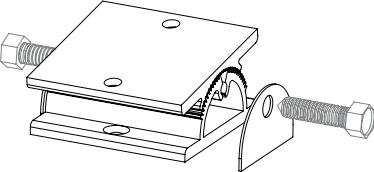





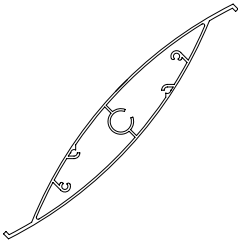
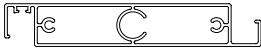
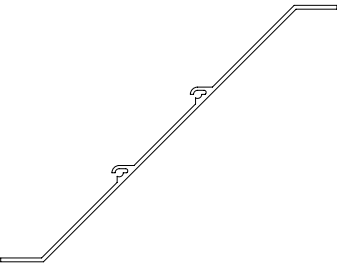
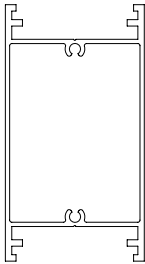
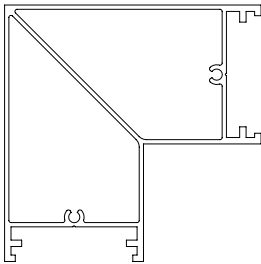
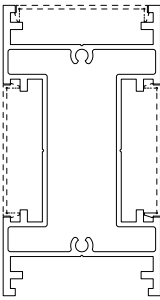
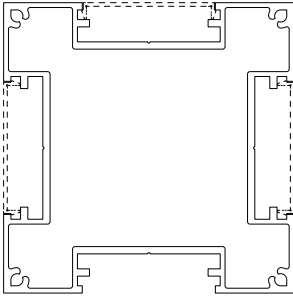

Shape / Forme	Description	Code	Price / Prix
	Transom support 0°-10° Support de traverse 0°-10°	272-240	2,90 €/pc
	Transom support 0°-20° Support de traverse 0°-20°	272-241	5,80 €/pc

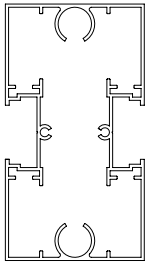

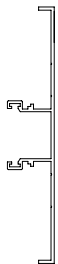
## **Profiles for Modern Pergola Profils de Pergola Moderne**

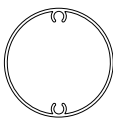

Shape / Forme	Description	Code	Weight / Poids	Price / Prix
	Curved louver 190mm Louvre ovale 190mm	2050-602	1811 gr/m	7,80 €/Kg
	Flat louver 120x20 Louvre droit 120x20	2050-607	1225 gr/m	7,80 €/Kg
	Fixed louver 120mm Louvre fixe 120mm	2050-610	1163 gr/m	7,80 €/Kg
	Column 120x65mm Poteau 120x65mm	2050-105	2503 gr/m	7,80 €/Kg
	Corner column 120x120mm Poteau en angle 120x120mm	2050-108	3574 gr/m	7,80 €/Kg
	Column 120x65mm Poteau 120x65mm	2050-102	3074 gr/m	7,80 €/Kg
	Column 120x120mm Poteau 120x120mm	2050-103	4759 gr/m	7,80 €/Kg





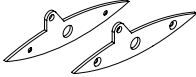
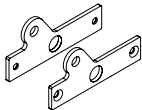
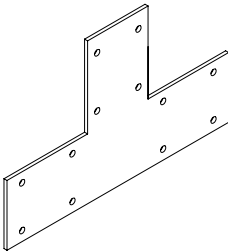
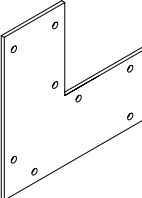
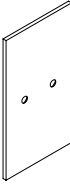
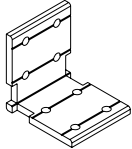

Shape / Forme	Description	Code	Weight / Poids	Price / Prix
	Transom 120x65mm Traverse 120x65mm	970-401	2503 gr/m	7,80 €/Kg
	Water drain Drainage d' eau	970-907	795 gr/m	7,80 €/Kg
	Base for fixed louver Base de la louvre fixe	970-901	793 gr/m	7,80 €/Kg
	Transom 120x32.5mm Traverse 120x32.5mm	970-402	1856 gr/m	7,80 €/Kg
	Water drain Ø45 Drainage d' eau Ø45	970-905	515 gr/m	7,80 €/Kg
	Cover for transom Capuchon de traverse	970-906	194 gr/m	7,80 €/Kg
	Cover for column Capuchon de poteau	2050-1K2	257 gr/m	7,80 €/Kg
	Guide Guidage	823	751 gr/m	7,80 €/Kg

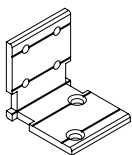
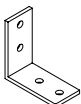
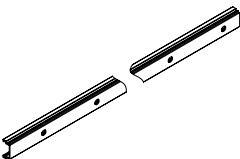
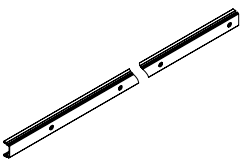
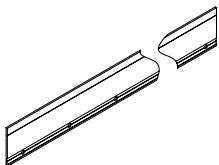

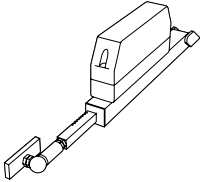

**Accessories for Modern Pergola**  
**Accessoires de Pergola Moderne**

Shape / Forme	Description	Code	Price / Prix
	End cap for louver 2050-602 Embout de louver 2050-602	272-249	9,10 €/pair
	End cap for louver 2050-607 Embout de louver 2050-607	272-247	2,70 €/pair
	T connector for transom T jonction de traverse	272-257	6,50 €/pc
	T connector for transom T jonction de traverse	272-258	5,00 €/pc
	End cap for transom 970-401 Embout de louver 970-401	272-248	2,90 €/pc
	Corner connector for column Equerre de poteau	2050-022	5,10 €/pc

Shape / Forme	Description	Code	Price / Prix
	Corner connector for column Equerre de poteau	2050-012	5,90 €/pc
	Corner connector for transom Equerre de liaison de traverse	272-267	1,75 €/pc
	Base profile for rotation louver 2050-607 (3m) Base de rotation de louver 2050-607 (3m)	272-262	19,00 €/pc
	Base profile for rotation louver 2050-602 (3m) Base de rotation de louver (3m)	272-263	19,00 €/pc
	Motion blade for movable louver 2050-607 (3m) Lame de mouvement de louver 2050-607 (3m)	272-264	27,20 €/pc
	Motion blade for movable louver 2050-602 (3m) Lame de mouvement de louver 2050-602 (3m)	272-265	27,20 €/pc

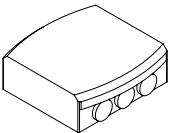
Shape / Forme	Description	Code	Price / Prix
	<p>Push pin for transom Broche avec ressort de traverse</p>	272-242	4,00 €/pc
	<p>Metallic push pin for transom Broche métallique avec ressort de traverse</p>	272-254	3,30 €/pc
	<p>Set: cotter-pin-washer Set: goupille-rondelle-cliquet</p>	272-261	2,70 €/pc
	<p>Corner connector for water drain 970-907 Equerre de liaison de drainage d' eau 970-907</p>	272-266	0,60 €/pc
	<p>Motor for louvers 450 Nt Moteur de louveres 450 Nt</p>	272-310	383,00 €/pc
	<p>Remote control for motor Télécommande de moteur</p>	272-351	41,90 €/pc

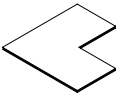
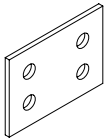
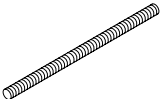
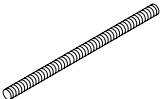
Shape / Forme	Description	Code	Price / Prix
	Motor receiver Moteur recepneur	272-350	159,40 €/pc
	Rubber gasket Joint	410-412	0,20 €/m
	Corner connector for water drain Equerre de liaison de drainage d' eau	272-272	1,10 €/pc
	Connector for motion blade 272-264 / 272-265 Jonction de lame de mouvement 272-264 / 272-265	272-271	0,50 €/pc
	Thread stud M6 x 70 mm Tige de jonction de moteur M6x70 mm	272-273	0,25 €/pc
	Threaded stud M6x110 mm Tige de jonction de moteur M6x110 mm	272-274	0,30 €/pc

# Dimensions - Pricelist

## Dimensions - Liste de prix

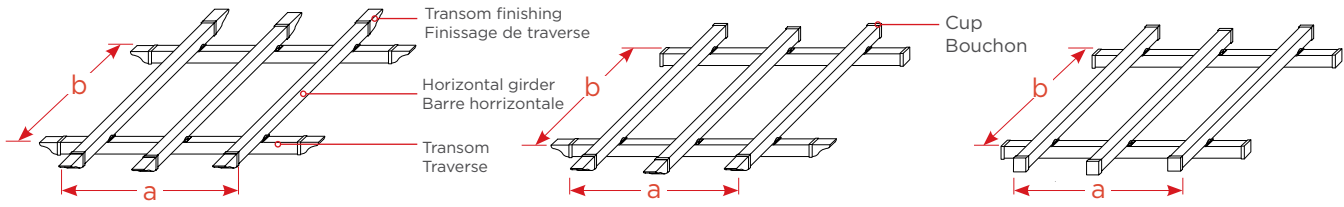

**Pergola No1**  
 Transom finishing  
 Finissage de traverse

**Pergola No2**  
 Transom finishing - Cups  
 Finissage de bouchon traverse

**Pergola No3**  
 Cups  
 Bouchon



## Column - Pricelist Poteau - Liste de prix

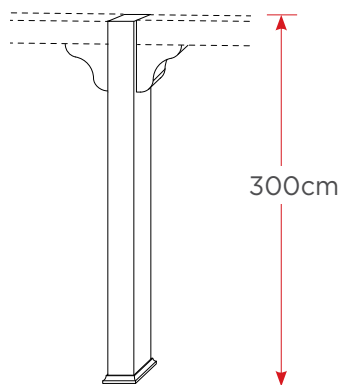

Transom finishing column  
Poteau avec finissage de la traverse

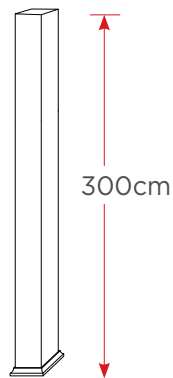





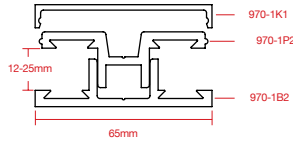

Simple column  
Simple poteau

### Notes

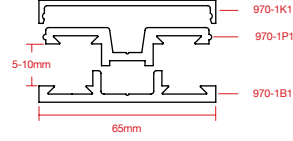
- The column profiles 900 and 901 are available in a length of 3 and 6m.
- The maximum distance from column to column can reach 3m.
- Prices does not include screws and anchoring materials.
- Profile in dimensions upon request are having extra charge of 20 €/m<sup>2</sup>
- Le profil du poteau 900 et 901 sont disponible en longueur de 3 et 6 m.
- Dimension maximum de colonne à colonne, 3m.
- Prix sans visserie et ancrage.
- Le supplément pour des coupes avec dimensions sur mesure est de 20 €/m<sup>2</sup>.

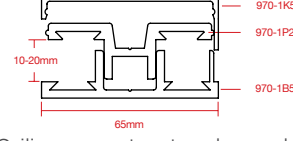
**Polycarbonate sheets support system  
Système de support de panneaux en  
polycarbonate**

Shape / Forme		Description	Code	Weight / Poids	Price / Prix
	 <p>Ceiling support system, heavy duty Système d'Appui d'Auvent, renforcé de plafond</p>	Joint cover Couvercle de joint	970-1K1	414 gr/m	7,80 €/Kg
		Pressure plate for joint Plaque de pression de joint	970-1P2	905 gr/m	7,80 €/Kg
		Supporting base for joint Base de liaison de joint	970-1B2	855 gr/m	7,80 €/Kg
	 <p>Ceiling support system, heavy duty Système d'Appui d'Auvent, renforcé de plafond</p>	Joint cover Couvercle de joint	970-1K1	414 gr/m	7,80 €/Kg
		Pressure plate for joint Plaque de pression de joint	970-1P1	801 gr/m	7,80 €/Kg
		Supporting base for joint Base de liaison de joint	970-1B1	759 gr/m	7,80 €/Kg
	 <p>Ceiling support system, heavy duty Système d'Appui d'Auvent, renforcé de plafond</p>	Joint cover Couvercle de joint	970-1K5	460 gr/m	7,80 €/Kg
		Pressure plate for joint Plaque de pression de joint	970-1P2	905 gr/m	7,80 €/Kg
		Supporting base for joint Base de liaison de joint	970-1B5	901 gr/m	7,80 €/Kg

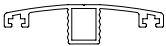
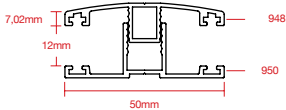
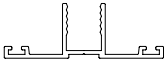
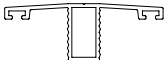
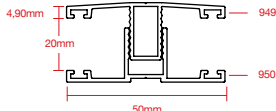
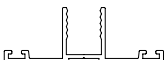
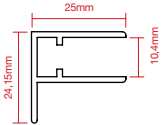
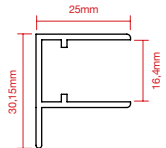
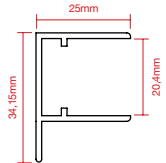
Shape / Forme	Description	Code	Weight / Poids	Price / Prix	
	 <p>Ceiling support system, light-duty Système d'Appui d'Auvent, type léger</p>	Joint cover Couvercle de joint	948	340 gr/m	7,80 €/Kg
		Joint supporting base Support de joint	950	328 gr/m	7,80 €/Kg
	 <p>Ceiling support system, light-duty Système d'Appui d'Auvent, type léger</p>	Joint cover Couvercle de joint	949	351 gr/m	7,80 €/Kg
		Joint supporting base Support de joint	950	328 gr/m	7,80 €/Kg
	Supporting profile "F" for multiwall polycarbonate sheets Profil "F" d'appui de panneaux en polycarbonate alveole	970-F10	303 gr/m	7,80 €/Kg	
	Supporting profile "F" for multiwall polycarbonate sheets Profil "F" d'appui de panneaux en polycarbonate alveole	970-F16	327 gr/m	7,80 €/Kg	
	Supporting profile "F" for multiwall polycarbonate sheets Profil "F" d'appui de panneaux en polycarbonate alveole	970-F20	343 gr/m	7,80 €/Kg	

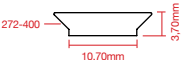
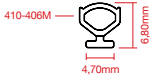
	Gasket EPDM Joint EPDM	272-400	1,10 €/m
	Gasket for profiles 948/949/950 Joint pour profil 948/949/950	410-406M	0,21 €/m



GR-32011 Inofita Viotia,  
Greece

T. +30 22620 47000

F. +30 22620 47090

[www.aluminco.com](http://www.aluminco.com)

[info@aluminco.com](mailto:info@aluminco.com)