



ALUMINCO[®]
ALUMINIUM BUILDING SYSTEMS





Panneaux de Portes / Door Panels

Liste de prix / Pricelist

Door1000 Series

Portes avec cadre prêts pour installation / Doors with frame ready for installation

CODE: 1010	COULEUR COLOR	DESCRIPTION		
	RAL/RAF	SIMPLE PORTE D'ENTREE SINGLE DOOR		
		AVEC FENETRE OUVRANTE SINGLE DOOR WITH OPENING WINDOW		
		THERMAL BREAK		
		SIMPLE PORTE D'ENTREE SINGLE DOOR		
		AVEC FENETRE OUVRANTE SINGLE DOOR WITH OPENING WINDOW		
		EXT. DIMS		
			Min.	Max.
HAUTEUR/HEIGHT (H):	215 cm	250 cm		
LARGEUR/WIDTH (W):	80 cm	110 cm		

CODE: 1030	COULEUR COLOR	DESCRIPTION		
	RAL/RAF	SIMPLE PORTE D'ENTREE SINGLE DOOR		
		THERMAL BREAK		
		SIMPLE PORTE D'ENTREE SINGLE DOOR		
		EXT. DIMS		
			Min.	Max.
		HAUTEUR/HEIGHT (H):	206 cm	225 cm
		LARGEUR/WIDTH (W):	80 cm	110 cm

CODE: 1015	COULEUR COLOR	DESCRIPTION	PRICE PRIX	
	RAL/RAF	PORTE D'ENTREE SIMPLE AVEC PARTIE FIXE SINGLE DOOR WITH SIDE PART		
		AVEC FENETRE OUVRANTE SINGLE DOOR WITH OPENING WINDOW		
		THERMAL BREAK		
		PORTE D'ENTREE SIMPLE AVEC PARTIE FIXE SINGLE DOOR WITH SIDE PART		
		AVEC FENETRE OUVRANTE SINGLE DOOR WITH OPENING WINDOW		
		EXT. DIMS		
			Min.	Max.
HAUTEUR/HEIGHT (H):	215 cm	250 cm		
LARGEUR/WIDTH (W):	130 cm	150 cm		

CODE: 1035	COULEUR COLOR	DESCRIPTION		
	RAL/RAF	PORTE D'ENTREE SIMPLE AVEC PARTIE FIXE SINGLE DOOR WITH SIDE PART		
		THERMAL BREAK		
		PORTE D'ENTREE SIMPLE AVEC PARTIE FIXE SINGLE DOOR WITH SIDE PART		
		EXT. DIMS		
			Min.	Max.
		HAUTEUR/HEIGHT (H):	206 cm	225 cm
		LARGEUR/WIDTH (W):	130 cm	150 cm

CODE: 1020	COULEUR COLOR	DESCRIPTION		
	RAL/RAF	DOUBLE PORTE D'ENTREE DOUBLE DOOR		
		DOUBLE AVEC FENETRE OUVRANTE DOUBLE DOOR WITH OPENING WINDOW		
		THERMAL BREAK		
		DOUBLE PORTE D'ENTREE DOUBLE DOOR		
		DOUBLE AVEC FENETRE OUVRANTE DOUBLE DOOR WITH OPENING WINDOW		
		EXT. DIMS		
			Min.	Max.
HAUTEUR/HEIGHT (H):	215 cm	250 cm		
LARGEUR/WIDTH (W):	150 cm	196 cm		

CODE: 1040	COULEUR COLOR	DESCRIPTION		
	RAL/RAF	DOUBLE PORTE D'ENTREE DOUBLE DOOR		
		THERMAL BREAK		
		DOUBLE PORTE D'ENTREE DOUBLE DOOR		
		EXT. DIMS		
			Min.	Max.
		HAUTEUR/HEIGHT (H):	206 cm	225 cm
		LARGEUR/WIDTH (W):	150 cm	196 cm

HAUTEUR MIN. 210 AVEC BAS EN ALUMINIUM FONDU. POUR HAUTEUR À 250 NOUS PROPOSONS SKYLIGHT
MIN HEIGHT 210 WITH BOTTOM CAST PART. FOR HEIGHT UP TO 250 WE SUGGEST SKYLIGHT

HAUTEUR MIN. 200 AVEC BAS EN ALUMINIUM FONDU. POUR HAUTEUR À 225 NOUS PROPOSONS SKYLIGHT
LIGH MIN HEIGHT 200 WITH BOTTOM CAST PART. FOR HEIGHT UP TO 225 WE SUGGEST SKYLIGHT

Les prix pour les portes serie 1000 sont disponibles selon demande.
Prices for the 1000 series doors will be available upon request.

Door1000 Series

Portes avec cadre prêts pour installation /
Doors with frame ready for installation

CODE: 1050	COULEUR COLOR	DESCRIPTION	PRICE PRIX	
	RAL/RAF	SIMPLE PORTE D'ENTREE SINGLE DOOR		
		AVEC FENETRE OUVRANTE WITH OPENING WINDOW		
		THERMAL BREAK		
		SIMPLE PORTE D'ENTREE SINGLE DOOR		
		AVEC FENETRE OUVRANTE WITH OPENING WINDOW		
		EXT. DIMS		
			Min.	Max.
		HAUTEUR/HEIGHT (H):	215 cm	225 cm
		LARGEUR/WIDTH (W):	80 cm	110 cm

CODE: 1070	COULEUR COLOR	DESCRIPTION	PRICE PRIX	
	RAL/RAF	SIMPLE PORTE D'ENTREE SINGLE DOOR		
		AVEC FENETRE OUVRANTE WITH OPENING WINDOW		
		THERMAL BREAK		
		SIMPLE PORTE D'ENTREE SINGLE DOOR		
		AVEC FENETRE OUVRANTE WITH OPENING WINDOW		
		EXT. DIMS		
			Min.	Max.
		HAUTEUR/HEIGHT (H):	215 cm	225 cm
		LARGEUR/WIDTH (W):	80 cm	110 cm

CODE: 1055	COULEUR COLOR	DESCRIPTION	PRICE PRIX	
	RAL/RAF	PORTE D'ENTREE SIMPLE AVEC PARTIE FIXE SINGLE DOOR WITH SIDE PART		
		AVEC FENETRE OUVRANTE WITH OPENING WINDOW		
		THERMAL BREAK		
		PORTE D'ENTREE SIMPLE AVEC PARTIE FIXE SINGLE DOOR WITH SIDE PART		
		AVEC FENETRE OUVRANTE WITH OPENING WINDOW		
		EXT. DIMS		
			Min.	Max.
		HAUTEUR/HEIGHT (H):	215 cm	225 cm
		LARGEUR/WIDTH (W):	130 cm	150 cm

CODE: 1075	COULEUR COLOR	DESCRIPTION	PRICE PRIX	
	RAL/RAF	PORTE D'ENTREE SIMPLE AVEC PARTIE FIXE WITH OPENING WINDOW		
		AVEC FENETRE OUVRANTE WITH OPENING WINDOW		
		THERMAL BREAK		
		PORTE D'ENTREE SIMPLE AVEC PARTIE FIXE SINGLE DOOR WITH SIDE PART		
		AVEC FENETRE OUVRANTE WITH OPENING WINDOW		
		EXT. DIMS		
			Min.	Max.
		HAUTEUR/HEIGHT (H):	215 cm	225 cm
		LARGEUR/WIDTH (W):	130 cm	150 cm

CODE: 1060	COULEUR COLOR	DESCRIPTION	PRICE PRIX	
	RAL/RAF	DOUBLE PORTE D'ENTREE DOUBLE DOOR		
		DOUBLE AVEC FENETRE OUVRANTE DOUBLE DOOR WITH OPENING WINDOW		
		THERMAL BREAK		
		DOUBLE PORTE D'ENTREE DOUBLE DOOR		
		DOUBLE AVEC FENETRE OUVRANTE DOUBLE DOOR WITH OPENING WINDOW		
		EXT. DIMS		
			Min.	Max.
		HAUTEUR/HEIGHT (H):	215 cm	225 cm
		LARGEUR/WIDTH (W):	150 cm	196 cm

CODE: 1080	COULEUR COLOR	DESCRIPTION	PRICE PRIX	
	RAL/RAF	DOUBLE PORTE D'ENTREE DOUBLE DOOR		
		DOUBLE AVEC FENETRE OUVRANTE DOUBLE DOOR WITH OPENING WINDOW		
		THERMAL BREAK		
		DOUBLE PORTE D'ENTREE DOUBLE DOOR		
		DOUBLE AVEC FENETRE OUVRANTE DOUBLE DOOR WITH OPENING WINDOW		
		EXT. DIMS		
			Min.	Max.
		HAUTEUR/HEIGHT (H):	215 cm	225 cm
		LARGEUR/WIDTH (W):	150 cm	196 cm

HAUTEUR MIN. 210 AVEC BAS EN ALUMINIUM FONDU. POUR HAUTEUR À 250 NOUS PROPO-
SONS SKYLIGHT
MIN HEIGHT 210 WITH BOTTOM CAST PART - FOR HEIGHT UP TO 250 WE SUGGEST
SKYLIGHT

HAUTEUR MIN. 210 AVEC BAS EN ALUMINIUM FONDU. POUR HAUTEUR À 250 NOUS PROPO-
SONS SKYLIGHT
MIN HEIGHT 210 WITH BOTTOM CAST PART - FOR HEIGHT UP TO 250 WE SUGGEST
SKYLIGHT

Les prix pour les portes serie 1000 sont disponibles selon demande.
Prices for the 1000 series doors will be available upon request.

P100 Series Classic

Panneau traditionnel avec aluminium fondu decoratives / Traditional panel with decorative castings



CODE	DESCRIPTION	PRICE PRIX
P102	BLIND	602 €
P100	GRILLE WITH 1 GLASS SAFETY	710 €
P155	VITRO	980 €
Aluminium Couvre / Covering 90x210		390 €
Aluminium Couvre / Covering 100x225		425 €
AVEC FENETRE OUVRANTE WITH OPENING WINDOW		1081 €
DIMENSIONS		
HAUTEUR/HEIGHT (H):		185
LARGEUR/WIDTH (W):		52



CODE	DESCRIPTION	PRICE PRIX
P152	BLIND	602 €
P180	GRILLE WITH 1 GLASS SAFETY	710 €
Aluminium Couvre / Covering 90x210		390 €
Aluminium Couvre / Covering 100x225		425 €
AVEC FENETRE OUVRANTE WITH OPENING WINDOW		1081 €
DIMENSIONS		
HAUTEUR/HEIGHT (H):		192
LARGEUR/WIDTH (W):		55



CODE	DESCRIPTION	PRICE PRIX
P162	BLIND	871 €
P163	2 VERRES GRILLE 2 GLASSES SAFETY	1020 €
Aluminium Couvre / Covering 90x210		590 €
Aluminium Couvre / Covering 100x225		625 €
DIMENSIONS		
HAUTEUR/HEIGHT (H):		192
LARGEUR/WIDTH (W):		71



CODE	DESCRIPTION	PRICE PRIX
P112	BLIND	602 €
P110	GRILLE WITH 1 GLASS SAFETY	710 €
	VITRO	980 €
Aluminium Couvre / Covering 90x210		390 €
Aluminium Couvre / Covering 100x225		425 €
DIMENSIONS		
HAUTEUR/HEIGHT (H):		179.5
LARGEUR/WIDTH (W):		52



CODE	DESCRIPTION	PRICE PRIX
P152	BLIND	602 €
P176	GRILLE WITH 1 GLASS SAFETY	710 €
Aluminium Couvre / Covering 90x210		390 €
Aluminium Couvre / Covering 100x225		425 €
AVEC FENETRE OUVRANTE WITH OPENING WINDOW		1081 €
DIMENSIONS		
HAUTEUR/HEIGHT (H):		192
LARGEUR/WIDTH (W):		55



CODE	DESCRIPTION	PRICE PRIX
P132	BLIND	871 €
P171	2 VERRES GRILLE 2 GLASSES SAFETY	1020 €
Aluminium Couvre / Covering 90x210		590 €
Aluminium Couvre / Covering 100x225		625 €
DIMENSIONS		
HAUTEUR/HEIGHT (H):		185
LARGEUR/WIDTH (W):		67.5



CODE	DESCRIPTION	PRICE PRIX
P102	BLIND	602 €
P120	GRILLE WITH 1 GLASS SAFETY	710 €
Aluminium Couvre / Covering 90x210		390 €
Aluminium Couvre / Covering 100x225		425 €
AVEC FENETRE OUVRANTE WITH OPENING WINDOW		1081 €
DIMENSIONS		
HAUTEUR/HEIGHT (H):		185
LARGEUR/WIDTH (W):		52



CODE	DESCRIPTION	PRICE PRIX
P152	BLIND	602 €
P178	GRILLE WITH 1 GLASS SAFETY	710 €
Aluminium Couvre / Covering 90x210		390 €
Aluminium Couvre / Covering 100x225		425 €
AVEC FENETRE OUVRANTE With opening window		1081 €
DIMENSIONS		
HAUTEUR/HEIGHT (H):		192
LARGEUR/WIDTH (W):		55



CODE	DESCRIPTION	PRICE PRIX
P132	BLIND	871 €
P130	2 VERRES GRILLE 2 GLASSES SAFETY	1020 €
Aluminium Couvre / Covering 90x210		590 €
Aluminium Couvre / Covering 100x225		625 €
DIMENSIONS		
HAUTEUR/HEIGHT (H):		185
LARGEUR/WIDTH (W):		67.5



CODE	DESCRIPTION	PRICE PRIX
P152	BLIND	602 €
P154	VITRO	980 €
Aluminium Couvre / Covering 90x210		390 €
Aluminium Couvre / Covering 100x225		425 €
DIMENSIONS		
HAUTEUR/HEIGHT (H):		192
LARGEUR/WIDTH (W):		55



CODE	DESCRIPTION	PRICE PRIX
P142	BLIND	871 €
P140	2 VERRES GRILLE 2 GLASSES SAFETY	1020 €
Aluminium Couvre / Covering 90x210		590 €
Aluminium Couvre / Covering 100x225		625 €
DIMENSIONS		
HAUTEUR/HEIGHT (H):		179.5
LARGEUR/WIDTH (W):		67.5



CODE	DESCRIPTION	PRICE PRIX
P132	BLIND	871 €
P150	2 VERRES GRILLE 2 GLASSES SAFETY	1020 €
Aluminium Couvre / Covering 90x210		590 €
Aluminium Couvre / Covering 100x225		625 €
DIMENSIONS		
HAUTEUR/HEIGHT (H):		185
LARGEUR/WIDTH (W):		67.5

P100 Series Classic

Panneau traditionnel avec aluminium fondu decoratives / Traditional panel with decorative castings

	CODE	DESCRIPTION	PRICE PRIX		CODE	DESCRIPTION	PRICE PRIX		CODE	DESCRIPTION	PRICE PRIX			
	P102	BLIND	602 €		P162	BLIND	871 €		P162	BLIND	871 €			
	P170	GRILLE WITH 1 GLASS SAFETY	710 €		P160	2 VERRES GRILLE 2 GLASSES SAFETY	1020 €		P164	2 VERRES GRILLE 2 GLASSES SAFETY	1020 €			
	Aluminium Couvre / Covering 90x210				390 €	Aluminium Couvre / Covering 90x210			590 €	Aluminium Couvre / Covering 90x210			590 €	
	Aluminium Couvre / Covering 100x225				425 €	Aluminium Couvre / Covering 100x225			625 €	Aluminium Couvre / Covering 100x225			625 €	
	AVEC FENETRE OUVRANTE WITH OPENING WINDOW				1081 €	AVEC FENETRE OUVRANTE WITH OPENING WINDOW			1081 €	AVEC FENETRE OUVRANTE WITH OPENING WINDOW			1081 €	
DIMENSIONS														
HAUTEUR/HEIGHT (H):			185	HAUTEUR/HEIGHT (H):			192	HAUTEUR/HEIGHT (H):			192			
LARGEUR/WIDTH (W):			52	LARGEUR/WIDTH (W):			71	LARGEUR/WIDTH (W):			71			

	CODE	DESCRIPTION	PRICE PRIX		CODE	DESCRIPTION	PRICE PRIX		CODE	DESCRIPTION	PRICE PRIX			
	P102	BLIND	602 €		P152	BLIND	602 €		P135	BLIND	710 €			
	P183	GRILLE WITH 1 GLASS SAFETY	710 €		P182	GRILLE WITH 1 GLASS SAFETY	710 €		P136	2 VERRES GRILLE 2 GLASSES SAFETY	865 €			
	Aluminium Couvre / Covering 90x210				390 €	Aluminium Couvre / Covering 90x210			390 €	Aluminium Couvre / Covering 90x210			450 €	
	Aluminium Couvre / Covering 100x225				425 €	Aluminium Couvre / Covering 100x225			425 €	Aluminium Couvre / Covering 100x225			485 €	
	AVEC FENETRE OUVRANTE WITH OPENING WINDOW				1081 €	AVEC FENETRE OUVRANTE WITH OPENING WINDOW			1081 €	AVEC FENETRE OUVRANTE WITH OPENING WINDOW			1081 €	
DIMENSIONS														
HAUTEUR/HEIGHT (H):			185	HAUTEUR/HEIGHT (H):			192	HAUTEUR/HEIGHT (H):			185			
LARGEUR/WIDTH (W):			52	LARGEUR/WIDTH (W):			55	LARGEUR/WIDTH (W):			67			

	CODE	DESCRIPTION	PRICE PRIX		CODE	DESCRIPTION	PRICE PRIX		CODE	DESCRIPTION	PRICE PRIX			
	P123	BLIND	527 €		P147	BLIND	602 €		P167	BLIND	602 €			
	P124	GRILLE WITH 1 GLASS SAFETY	871 €		P189	GRILLE WITH 1 GLASS SAFETY	710 €		P168	GRILLE WITH 1 GLASS SAFETY	710 €			
	Aluminium Couvre / Covering 90x210				325 €	Aluminium Couvre / Covering 90x210			390 €	Aluminium Couvre / Covering 90x210			390 €	
	Aluminium Couvre / Covering 100x225				360 €	Aluminium Couvre / Covering 100x225			425 €	Aluminium Couvre / Covering 100x225			425 €	
	AVEC FENETRE OUVRANTE WITH OPENING WINDOW				1081 €	AVEC FENETRE OUVRANTE WITH OPENING WINDOW			1081 €	AVEC FENETRE OUVRANTE WITH OPENING WINDOW			1081 €	
DIMENSIONS														
HAUTEUR/HEIGHT (H):			173	HAUTEUR/HEIGHT (H):			193	HAUTEUR/HEIGHT (H):			192			
LARGEUR/WIDTH (W):			52	LARGEUR/WIDTH (W):			55	LARGEUR/WIDTH (W):			55			

	CODE	DESCRIPTION	PRICE PRIX		CODE	DESCRIPTION	PRICE PRIX		CODE	DESCRIPTION	PRICE PRIX			
	P147	BLIND	602 €		P147	BLIND	602 €		P147	BLIND	602 €			
	P149	GRILLE WITH 1 GLASS SAFETY	710 €		P148	GRILLE WITH 1 GLASS SAFETY	710 €		P198	GRILLE WITH 1 GLASS SAFETY	617 €			
	Aluminium Couvre / Covering 90x210				390 €	Aluminium Couvre / Covering 90x210			390 €	Aluminium Couvre / Covering 90x210			390 €	
	Aluminium Couvre / Covering 100x225				425 €	Aluminium Couvre / Covering 100x225			425 €	Aluminium Couvre / Covering 100x225			425 €	
	AVEC FENETRE OUVRANTE WITH OPENING WINDOW				1081 €	AVEC FENETRE OUVRANTE WITH OPENING WINDOW			1081 €	AVEC FENETRE OUVRANTE WITH OPENING WINDOW			1081 €	
DIMENSIONS														
HAUTEUR/HEIGHT (H):			193	HAUTEUR/HEIGHT (H):			193	HAUTEUR/HEIGHT (H):			193			
LARGEUR/WIDTH (W):			55	LARGEUR/WIDTH (W):			55	LARGEUR/WIDTH (W):			55			

P100 Series Classic

Panneau traditionnel avec aluminium fondu decoratives / Traditional panel with decorative castings

CODE	DESCRIPTION	PRICE PRIX
 P167	BLIND	602 €
P174	GRILLE WITH 1 GLASS SAFETY	710 €
Aluminium Couvre / Covering 90x210		390 €
Aluminium Couvre / Covering 100x225		425 €
AVEC FENETRE OUVRANTE WITH OPENING WINDOW		1081 €
DIMENSIONS		
HAUTEUR/HEIGHT (H):		192
LARGEUR/WIDTH (W):		55

CODE	DESCRIPTION	PRICE PRIX
 P167	BLIND	602 €
P169	GRILLE WITH 1 GLASS SAFETY	710 €
Aluminium Couvre / Covering 90x210		390 €
Aluminium Couvre / Covering 100x225		425 €
AVEC FENETRE OUVRANTE WITH OPENING WINDOW		1081 €
DIMENSIONS		
HAUTEUR/HEIGHT (H):		192
LARGEUR/WIDTH (W):		55

CODE	DESCRIPTION	PRICE PRIX
 P167	BLIND	602 €
P199	GRILLE WITH 1 GLASS SAFETY	710 €
Aluminium Couvre / Covering 90x210		390 €
Aluminium Couvre / Covering 100x225		425 €
AVEC FENETRE OUVRANTE WITH OPENING WINDOW		1081 €
DIMENSIONS		
HAUTEUR/HEIGHT (H):		192
LARGEUR/WIDTH (W):		55

Panneau traditionnel sans aluminium fondu decoratives / Traditional panel without decorative castings

CODE	DESCRIPTION	PRICE PRIX
 P103	BLIND	479 €
P101	GRILLE WITH 1 GLASS SAFETY	580 €
Aluminium Couvre / Covering 90x210		250 €
Aluminium Couvre / Covering 100x225		285 €
AVEC FENETRE OUVRANTE WITH OPENING WINDOW		958 €
DIMENSIONS		
HAUTEUR/HEIGHT (H):		169
LARGEUR/WIDTH (W):		47

CODE	DESCRIPTION	PRICE PRIX
 P133	BLIND	628 €
P131	2 VERRES GRILLE 2 GLASSES SAFETY	783 €
Aluminium Couvre / Covering 90x210		325 €
Aluminium Couvre / Covering 100x225		360 €
DIMENSIONS		
HAUTEUR/HEIGHT (H):		169
LARGEUR/WIDTH (W):		62,5

CODE	DESCRIPTION	PRICE PRIX
 P103	BLIND	479 €
P121	GRILLE WITH 1 GLASS SAFETY	581 €
Aluminium Couvre / Covering 90x210		250 €
Aluminium Couvre / Covering 100x225		285 €
AVEC FENETRE OUVRANTE WITH OPENING WINDOW		958 €
DIMENSIONS		
HAUTEUR/HEIGHT (H):		169
LARGEUR/WIDTH (W):		47

CODE	DESCRIPTION	PRICE PRIX
 P133	BLIND	628 €
P151	2 VERRES GRILLE 2 GLASSES SAFETY	783 €
Aluminium Couvre / Covering 90x210		325 €
Aluminium Couvre / Covering 100x225		360 €
DIMENSIONS		
HAUTEUR/HEIGHT (H):		169
LARGEUR/WIDTH (W):		62,5

CODE	DESCRIPTION	PRICE PRIX
 P113	BLIND	479 €
P111	GRILLE WITH 1 GLASS SAFETY	581 €
Aluminium Couvre / Covering 90x210		250 €
Aluminium Couvre / Covering 100x225		285 €
DIMENSIONS		
HAUTEUR/HEIGHT (H):		172
LARGEUR/WIDTH (W):		47

CODE	DESCRIPTION	PRICE PRIX
 P143	BLIND	628 €
P141	2 VERRES GRILLE 2 GLASSES SAFETY	783 €
Aluminium Couvre / Covering 90x210		325 €
Aluminium Couvre / Covering 100x225		360 €
DIMENSIONS		
HAUTEUR/HEIGHT (H):		172
LARGEUR/WIDTH (W):		62,5

CODE	DESCRIPTION	PRICE PRIX
 P103	BLIND	479 €
P181	GRILLE WITH 1 GLASS SAFETY	581 €
Aluminium Couvre / Covering 90x210		250 €
Aluminium Couvre / Covering 100x225		485 €
AVEC FENETRE OUVRANTE WITH OPENING WINDOW		958 €
DIMENSIONS		
HAUTEUR/HEIGHT (H):		169
LARGEUR/WIDTH (W):		47

CODE	DESCRIPTION	PRICE PRIX
 P133	BLIND	628 €
P161	2 VERRES GRILLE 2 GLASSES SAFETY	783 €
Aluminium Couvre / Covering 90x210		325 €
Aluminium Couvre / Covering 100x225		360 €
DIMENSIONS		
HAUTEUR/HEIGHT (H):		169
LARGEUR/WIDTH (W):		62,5

CODE	DESCRIPTION	PRICE PRIX
 P190	BLIND	520 €
P191	GRILLE WITH 1 GLASS SAFETY	628 €
P192	2 VERRES GRILLE 2 GLASSES SAFETY	737 €
P193	3 VERRES GRILLE 3 GLASSES SAFETY	852 €
Aluminium Couvre / Covering 90x210		275 €
Aluminium Couvre / Covering 100x225		310 €
DIMENSIONS		
HAUTEUR/HEIGHT (H):		161
LARGEUR/WIDTH (W):		47

P100 Series Classic

	CODE	DESCRIPTION	PRICE PRIX
	P103	BLIND	479 €
	P158	1 VERRE / GLASS VITRO	810 €
	Aluminium Couvre / Covering 90x210		250 €
	Aluminium Couvre / Covering 100x225		285 €
	DIMENSIONS		
	HAUTEUR/HEIGHT (H):		169
LARGEUR/WIDTH (W):		47	

Panneau traditionnel avec aluminium fondu decoratives / Traditional panel with decorative castings

	CODE	DESCRIPTION	PRICE PRIX
	P157	BLIND	440 €
	P153	1 VERRE / GLASS VITRO	655 €
	DIMENSIONS		
	HAUTEUR/HEIGHT (H):		192
LARGEUR/WIDTH (W):		35	

	CODE	DESCRIPTION	PRICE PRIX
	P107	BLIND	440 €
	P105	GRILLE WITH 1 GLASS SAFETY	520 €
	DIMENSIONS		
	HAUTEUR/HEIGHT (H):		185
LARGEUR/WIDTH (W):		32	

	CODE	DESCRIPTION	PRICE PRIX
	P107	BLIND	440 €
	P125	GRILLE WITH 1 GLASS SAFETY	520 €
	DIMENSIONS		
	HAUTEUR/HEIGHT (H):		185
LARGEUR/WIDTH (W):		32	

	CODE	DESCRIPTION	PRICE PRIX
	P107	BLIND	440 €
	P175	GRILLE WITH 1 GLASS SAFETY	520 €
	DIMENSIONS		
	HAUTEUR/HEIGHT (H):		185
LARGEUR/WIDTH (W):		32	

	CODE	DESCRIPTION	PRICE PRIX
	P157	BLIND	440 €
	P185	GRILLE WITH 1 GLASS SAFETY	520 €
	DIMENSIONS		
	HAUTEUR/HEIGHT (H):		192
LARGEUR/WIDTH (W):		35	

	CODE	DESCRIPTION	PRICE PRIX
	P157	BLIND	440 €
	P179	GRILLE WITH 1 GLASS SAFETY	520 €
	DIMENSIONS		
	HAUTEUR/HEIGHT (H):		192
LARGEUR/WIDTH (W):		35	

	CODE	DESCRIPTION	PRICE PRIX
	P157	BLIND	440 €
	P177	GRILLE WITH 1 GLASS SAFETY	520 €
	DIMENSIONS		
	HAUTEUR/HEIGHT (H):		192
LARGEUR/WIDTH (W):		35	

	CODE	DESCRIPTION	PRICE PRIX
	P117	BLIND	440 €
	P115	GRILLE WITH 1 GLASS SAFETY	520 €
	DIMENSIONS		
	HAUTEUR/HEIGHT (H):		179,5
LARGEUR/WIDTH (W):		32	

	CODE	DESCRIPTION	PRICE PRIX
	P137	BLIND	440 €
	P138	GRILLE WITH 1 GLASS SAFETY	520 €
		1 VERRE / GLASS VITRO	655 €
	DIMENSIONS		
HAUTEUR/HEIGHT (H):		192	
LARGEUR/WIDTH (W):		35	

	CODE	DESCRIPTION	PRICE PRIX
	P127	BLIND	440 €
	P129	GRILLE WITH 1 GLASS SAFETY	520 €
	DIMENSIONS		
	HAUTEUR/HEIGHT (H):		193
LARGEUR/WIDTH (W):		36	

	CODE	DESCRIPTION	PRICE PRIX
	P127	BLIND	440 €
	P109	GRILLE WITH 1 GLASS SAFETY	520 €
	DIMENSIONS		
	HAUTEUR/HEIGHT (H):		193
LARGEUR/WIDTH (W):		36	

	CODE	DESCRIPTION	PRICE PRIX
	P127	BLIND	440 €
	P128	GRILLE WITH 1 GLASS SAFETY	520 €
	DIMENSIONS		
	HAUTEUR/HEIGHT (H):		193
LARGEUR/WIDTH (W):		36	

P100 Series Classic

Panneau traditionnel avec aluminium fondu decoratives / Traditional panel with decorative castings



CODE	DESCRIPTION	PRICE PRIX
P137	BLIND	440 €
P114	GRILLE WITH 1 GLASS SAFETY	520 €
DIMENSIONS		
HAUTEUR/HEIGHT (H):		192
LARGEUR/WIDTH (W):		35



CODE	DESCRIPTION	PRICE PRIX
P137	BLIND	440 €
P194	GRILLE WITH 1 GLASS SAFETY	520 €
DIMENSIONS		
HAUTEUR/HEIGHT (H):		192
LARGEUR/WIDTH (W):		35

Panneau traditionnel sans aluminium fondu decoratives / Traditional panel without decorative castings



CODE	DESCRIPTION	PRICE PRIX
P108	BLIND	317 €
P106	GRILLE WITH 1 GLASS SAFETY	398 €
DIMENSIONS		
HAUTEUR/HEIGHT (H):		169
LARGEUR/WIDTH (W):		27



CODE	DESCRIPTION	PRICE PRIX
P118	BLIND	317 €
P116	GRILLE WITH 1 GLASS SAFETY	398 €
DIMENSIONS		
HAUTEUR/HEIGHT (H):		172
LARGEUR/WIDTH (W):		27



CODE	DESCRIPTION	PRICE PRIX
P108	BLIND	317 €
P126	GRILLE WITH 1 GLASS SAFETY	398 €
DIMENSIONS		
HAUTEUR/HEIGHT (H):		169
LARGEUR/WIDTH (W):		27



CODE	DESCRIPTION	PRICE PRIX
P108	BLIND	317 €
P186	GRILLE WITH 1 GLASS SAFETY	398 €
DIMENSIONS		
HAUTEUR/HEIGHT (H):		169
LARGEUR/WIDTH (W):		27

P100 Series

SURCHARGE DIMENSIONS

- Panneau Lateral Blind 90x210cm +90 € du prix catalogue
- Panneau Lateral 90x210cm avec vitrage +90 € du prix catalogue
- Surcharge pour vitrage Triplex +20 € (petit) et +35 € (grand)
- * Dimensions Standard: Panneau total 90x210cm / Panneau Lateral 45x210cm

LARGEUR/WIDTH (W)	HAUTEUR/HEIGHT (H)	CHARGE
45 cm	225 cm	+ 20 €
100 cm	225 cm	+ 40 €

COULEUR EXTRA

- BLANC RAL 9016 - sans charge
- Peinture chez sous - traitant selon demand

EXTRA DIMENSION CHARGES

- Blind side panel in 90x210cm +90 € (w) in price of catalogue.
- Side panel with in 90x210cm (w) with glasses +90 € in price of catalogue.
- Extra charges per triplex glass +20 € on small and +35 € on big.
- * Standard dimensions: FULL PANEL 90x210cm/ SIDE PANEL 45x210cm

EXTRA COLOR

- WHITE RAL 9016 - without charge
- OUTSOURCING painting
- Outsourced basis pricelist (upon request)

SURCHARGE IMITATIONS BOIS

EXTRA CHARGES: WOOD IMITATION

P101/P103/P111/P113/P121/ P122/P158/ P181/P184	180,00 €
P100/P102/P120/P146/P147/P148/ P149/P152/P154/P155/P156/P167/ P168/P169/P170/P174/P176/P178/ P180/P182/P183/P189/P197/P198	220,00 €
P110/P112/P123/P124/P131/P133/P141/ P143/P151/P161/P190/P191/P192/193	220,00 €
P130/P132/P135/P136/P140/ P142/ P144/P150/P160/P162/P163/P164/ P171/P188	300,00 €
P106/P108/P116/P118/ P126/P186	120,00 €
P105/P107/P109/P114/P125/ P127/ P128/P129/P137/P138/ P153/P157/ P175/P177/P179/ P185/ P194	180,00 €
P115/P117	180,00 €

	PANNEAU TOTAL FULL PANEL	PANNEAU LATERAL SIDE PANEL	COUVRE D' ALUMINIUM ALUMINIUM COVERING
RAL	+ 60 €	+ 40 €	+ 30 €
MAT - SPECIALS	+ 90 €	+ 50 €	+ 45 €

I300 Series

Inox (Feuillage Aluminium / Aluminium sheet 2 mm)

	CODE	VERRE / GLASS	DESCRIPTION	PRICE PRIX
	I220		BLIND	548 €
	I221	1	VERRE SABLEE / GLASS SANDBLAST	642 €
	I221	1	VERRE / GLASS SUPER SILVER	838 €
Aluminium Couvre/Covering (mdf 4 / 6mm) 90x210cmx2mm				285 €
Aluminium Couvre/Covering (mdf 4 / 6mm)100x225cmx2mm				310 €

	CODE	VERRE / GLASS	DESCRIPTION	PRICE PRIX
	I236		BLIND	418 €
	Dessin avec 6 gravures pantographes. Option de 7 / 8 gravures horizontales. Largeur gravures: 5 mm			
	Aluminium Couvre/Covering (mdf 4 / 6mm) 90x210cmx2mm			
Aluminium Couvre/Covering (mdf 4 / 6mm)100x225cmx2mm				245 €

	CODE	VERRE / GLASS	DESCRIPTION	PRICE PRIX
	I224		BLIND	817 €
	Dessin avec 6 gravures pantographes. Largeur gravures: 5 mm 6 pantograph engravings. Engravings width: 5 mm			
	Aluminium Couvre/Covering (mdf 4 / 6mm) 90x210cmx2mm			
Aluminium Couvre/Covering (mdf 4 / 6mm)100x225cmx2mm				445 €

	CODE	VERRE / GLASS	DESCRIPTION	PRICE PRIX
	I240		BLIND	560 €
	I241	1	SABLEE / SANDBLAST	750 €
	I242	2	SABLEE / SANDBLAST	783 €
	I243	3	SABLEE / SANDBLAST	810 €
Aluminium Couvre/Covering (mdf 4 / 6mm) 90x210cmx2mm				290 €
Aluminium Couvre/Covering (mdf 4 / 6mm)100x225cmx2mm				315 €

	CODE	VERRE / GLASS	DESCRIPTION	PRICE PRIX
	I225		BLIND	494 €
	Dessin avec 5 gravures pantographes. Option de 6 / 7 / 8 gravures horizontales. Largeur gravures: 10 mm 5 pantograph engravings. Optional 6 or 7 or 8 horizontal engravings. Engravings width: 10 mm			
	Aluminium Couvre/Covering (mdf 4 / 6mm) 90x210cmx2mm			
Aluminium Couvre/Covering (mdf 4 / 6mm)100x225cmx2mm				285 €

	CODE	VERRE / GLASS	DESCRIPTION	PRICE PRIX
	I245		BLIND	533 €
	Dessin avec 5 gravures pantographes. Option de 6 / 7 / 8 gravures horizontales. Largeur gravures: 10 mm 5 pantograph engravings. Optional 6 or 7 or 8 horizontal engravings. Engravings width: 10 mm			
	Aluminium Couvre/Covering (mdf 4 / 6mm) 90x210cmx2mm			
Aluminium Couvre/Covering (mdf 4 / 6mm)100x225cmx2mm				305 €

	CODE	VERRE / GLASS	DESCRIPTION	PRICE PRIX
	I226		BLIND	520 €
	Σχέδιο με 6 παντογραφικές χαραξίες. Δίνεται η δυνατότητα για 7 ή 8 οριζόντιες χαραξίες. Πλάτος χάραξης: 10 mm 6 pantograph engravings. Optional 7 or 8 horizontal engravings. Engravings width: 10 mm			
	Aluminium Couvre/Covering (mdf 4 / 6mm) 90x210cmx2mm			
Aluminium Couvre/Covering (mdf 4 / 6mm)100x225cmx2mm				305 €

	CODE	VERRE / GLASS	DESCRIPTION	PRICE PRIX
	I250		BLIND	595 €
	I253	3	SABLEE / SANDBLAST	682 €
	I253	3	VERRE / GLASS SUPER SILVER	783 €
Aluminium Couvre/Covering (mdf 4 / 6mm) 90x210cm				310 €
Aluminium Couvre/Covering (mdf 4 / 6mm) 100x225cm				335 €

	CODE	VERRE / GLASS	DESCRIPTION	PRICE PRIX
	I235		BLIND	392 €
	Dessin avec 5 gravures pantographes. Option de 6 / 7 / 8 gravures horizontales. Largeur gravures: 5 mm 5 pantograph engravings. Optional 6 or 7 or 8 horizontal engravings. Engravings width: 5 mm			
	Aluminium Couvre/Covering (mdf 4 / 6mm) 90x210cmx2mm			
Aluminium Couvre/Covering (mdf 4 / 6mm)100x225cmx2mm				235 €

	CODE	VERRE / GLASS	DESCRIPTION	PRICE PRIX
	I270		BLIND	614 €
	I271	1	SABLEE / SANDBLAST	689 €
	I271	1	VERRE / GLASS SUPER SILVER	730 €
Aluminium Couvre/Covering (mdf 4 / 6mm) 90x210cm				320 €
Aluminium Couvre/Covering (mdf 4 / 6mm)100x225cm				345 €

POUR PANNEAU AVEC FENETRE INOX, AJOUTEZ LA TETTRE "M" A LA FIN DU CODE EX.: I395M
FOR DECORATIVE PANEL WITH OPENING WINDOW INOX, ADD THE LETTER "M" AT THE END OF THE CODE, I.E. I395M

I300 Series

Inox (Feuillage Aluminium / Aluminium sheet 2 mm)

CODE	VERRE / GLASS	DESCRIPTION	PRICE PRIX
I335		BLIND	520 €
I337	2	VERRE / GLASS CATHEDRAL	662 €
I337	2	VERRE / GLASS FUSED	898 €
			Aluminium Couvre/Covering (mdf 4 / 6mm) 90x210cm 270 € Aluminium Couvre/Covering (mdf 4 / 6mm)100x225cm 295 €

CODE	VERRE / GLASS	DESCRIPTION	PRICE PRIX
I343		BLIND	548 €
I344	1	SABLEE / SANDBLAST	595 €
I344	1	VERRE / GLASS SUPER SILVER	654 €
			Aluminium Couvre/Covering (mdf 4 / 6mm) 90x210cm 320 € Aluminium Couvre/Covering (mdf 4 / 6mm)100x225cm 345 €

CODE	VERRE / GLASS	DESCRIPTION	PRICE PRIX
I383		BLIND	398 €
I384	1	SABLEE / SANDBLAST	446 €
I384	1	VERRE / GLASS SUPER SILVER	500 €
			

CODE	VERRE / GLASS	DESCRIPTION	PRICE PRIX
I345		BLIND	406 €
I346	4	VERRE / GLASS BR	560 €
I346	4	VERRE / GLASS FUSED	783 €
I346	4	VERRE / GLASS CATHEDRAL	548 €
			Aluminium Couvre/Covering (mdf 4 / 6mm) 90x210cm 215 € Aluminium Couvre/Covering (mdf 4 / 6mm)100x225cm 240 €

I300 Series Inox

CODE	VERRE / GLASS	DESCRIPTION	PRICE PRIX
I347		BLIND	748 €
I348	1	SABLEE / SANDBLAST	925 €
I348	1	VERRE / GLASS CATHEDRAL	911 €
I348	1	VERRE / GLASS SUPER SILVER	959 €
Aluminium Couvre/Covering (mdf 4 / 6mm) 90x210cm			470 €
Aluminium Couvre/Covering (mdf 4 / 6mm)100x225cm			495 €

CODE	VERRE / GLASS	DESCRIPTION	PRICE PRIX
I378		BLIND	697 €
I379	1	VERRE / GLASS CATHEDRAL	761 €
I379	1	SABLEE / SANDBLAST	776 €
I379	1	VERRE / GLASS SUPER SILVER	853 €
Aluminium Couvre/Covering (mdf 4 / 6mm) 90x210cm			370 €
Aluminium Couvre/Covering (mdf 4 / 6mm)100x225cm			395 €

CODE	VERRE / GLASS	DESCRIPTION	PRICE PRIX
I350		BLIND	467 €
I354	4	VERRE / GLASS SUPER SILVER	614 €
Aluminium Couvre/Covering (mdf 4 / 6mm) 90x210cm			245 €
Aluminium Couvre/Covering (mdf 4 / 6mm)100x225cm			270 €

CODE	VERRE / GLASS	DESCRIPTION	PRICE PRIX
I388		BLIND	533 €
I389	1	VERRE / GLASS CATHEDRAL	527 €
I389	1	SABLEE / SANDBLAST	574 €
I389	1	VERRE / GLASS SUPER SILVER	614 €

CODE	VERRE / GLASS	DESCRIPTION	PRICE PRIX
I357		BLIND	454 €
Aluminium Couvre/Covering (mdf 4 / 6mm) 90x210cm			240 €
Aluminium Couvre/Covering (mdf 4 / 6mm)100x225cm			265 €

CODE	VERRE / GLASS	DESCRIPTION	PRICE PRIX
I380		BLIND	548 €
I382	2	VERRE / GLASS CATHEDRAL	682 €
I382	2	VERRE / GLASS FUSED	972 €
Aluminium Couvre/Covering (mdf 4 / 6mm) 90x210cm			285 €
Aluminium Couvre/Covering (mdf 4 / 6mm)100x225cm			310 €

CODE	VERRE / GLASS	DESCRIPTION	PRICE PRIX
I385		BLIND	533 €
I387	4	VERRE / GLASS SUPER SILVER	614 €
Aluminium Couvre/Covering (mdf 4 / 6mm) 90x210cm			280 €
Aluminium Couvre/Covering (mdf 4 / 6mm)100x225cm			305 €

CODE	VERRE / GLASS	DESCRIPTION	PRICE PRIX
I375		BLIND	454 €
I376	5	VERRE / GLASS CATHEDRAL	548 €
Aluminium Couvre/Covering (mdf 4 / 6mm) 90x210cm			240 €
Aluminium Couvre/Covering (mdf 4 / 6mm)100x225cm			265 €
GRILLE DECORATIVE D' INOX DECORATIVE INOX SAFETY			100 €

CODE	VERRE / GLASS	DESCRIPTION	PRICE PRIX
I392		BLIND	667 €
I395	3	VERRE / GLASS CATHEDRAL	750 €
I395	3	VERRE / GLASS FUSED	893 €
Aluminium Couvre/Covering (mdf 4 / 6mm) 90x210cm			345 €
Aluminium Couvre/Covering (mdf 4 / 6mm)100x225cm			370 €

CODE	VERRE / GLASS	DESCRIPTION	PRICE PRIX
I367		BLIND	602 €
I369	3	VERRE / GLASS CATHEDRAL	682 €
I369	3	VERRE / GLASS FUSED	710 €

POUR PANNEAU AVEC FENETRE INOX, AJOUTEZ LA TETTRE "M" A LA FIN DU CODE EX.: I395M
FOR DECORATIVE PANEL WITH OPENING WINDOW INOX, ADD THE LETTER "M" AT THE END OF THE CODE, I.E. I395M

I300 Series Inox

CODE	VERRE / GLASS	DESCRIPTION	PRICE PRIX
I420		BLIND	520 €
I423	3	SABLEE / SANDBLAST	614 €
I423	3	VERRE / GLASS SUPER SILVER	716 €
Aluminium Couvre/Covering (mdf 4 / 6mm) 90x210cm			270 €
Aluminium Couvre/Covering (mdf 4 / 6mm)100x225cm			295 €

CODE	VERRE / GLASS	DESCRIPTION	PRICE PRIX
I425		BLIND	520 €
I428	3	SABLEE / SANDBLAST	695 €
I428	3	VERRE / GLASS SUPER SILVER	838 €
Aluminium Couvre/Covering (mdf 4 / 6mm) 90x210cm			270 €
Aluminium Couvre/Covering (mdf 4 / 6mm)100x225cm			295 €

CODE	VERRE / GLASS	DESCRIPTION	PRICE PRIX
I465		BLIND	520 €
I466	3	VERRE CATHEDRAL	569 €
I466	3	VERRE / GLASS SUPER SILVER	710 €
Aluminium Couvre/Covering (mdf 4 / 6mm) 90x210cm			270 €
Aluminium Couvre/Covering (mdf 4 / 6mm)100x225cm			295 €

CODE	VERRE / GLASS	DESCRIPTION	PRICE PRIX
I480		BLIND	541 €
I481	1	VERRE / GLASS CATHEDRAL	588 €
I481	1	SABLEE / SANDBLAST	602 €
Aluminium Couvre/Covering (mdf 4 / 6mm) 90x210cm			285 €
Aluminium Couvre/Covering (mdf 4 / 6mm)100x225cm			310 €

E2000 Series Classic

	CODE	VERRE / GLASS	DESCRIPTION	PRIX / PRICE
	E507		BLIND	177 €
	E508	2	PETIT BOIS / TRANSOM	284 €
	E508	2	GRILLE / SAFETY	381 €
Aluminium Couvre/Covering (mdf 4 / 6mm) 90x210cm				95 €
Aluminium Couvre/Covering (mdf 4 / 6mm)100x225cm				120 €

	CODE	VERRE / GLASS	DESCRIPTION	PRIX / PRICE
	E517		BLIND	177 €
	E518	1	PETIT BOIS / TRANSOM	262 €
	E518	1	GRILLE / SAFETY	388 €
Aluminium Couvre/Covering (mdf 4 / 6mm) 90x210cm				95 €
Aluminium Couvre/Covering (mdf 4 / 6mm)100x225cm				120 €

	CODE	VERRE / GLASS	DESCRIPTION	PRIX / PRICE
	E510		BLIND	177 €
	E514	1	PETIT BOIS / TRANSOM	262 €
	E514	1	GRILLE / SAFETY	388 €
Aluminium Couvre/Covering (mdf 4 / 6mm) 90x210cm				95 €
Aluminium Couvre/Covering (mdf 4 / 6mm)100x225cm				120 €

	CODE	VERRE / GLASS	DESCRIPTION	PRIX / PRICE
	E528		BLIND	177 €
	E529	1	PETIT BOIS / TRANSOM	311 €
	E529	1	DECO	431 €
Aluminium Couvre/Covering (mdf 4 / 6mm) 90x210cm				95 €
Aluminium Couvre/Covering (mdf 4 / 6mm)100x225cm				120 €

	CODE	VERRE / GLASS	DESCRIPTION	PRIX / PRICE
	E512		BLIND	177 €
	E515	1	PETIT BOIS / TRANSOM	262 €
	E515	1	GRILLE / SAFETY	388 €
Aluminium Couvre/Covering (mdf 4 / 6mm) 90x210cm				95 €
Aluminium Couvre/Covering (mdf 4 / 6mm)100x225cm				120 €

	CODE	VERRE / GLASS	DESCRIPTION	PRIX / PRICE
	E530		BLIND	177 €
	E531	1	PETIT BOIS / TRANSOM	262 €
	E531	1	GRILLE / SAFETY	388 €
Aluminium Couvre/Covering (mdf 4 / 6mm) 90x210cm				95 €
Aluminium Couvre/Covering (mdf 4 / 6mm)100x225cm				120 €

	CODE	VERRE / GLASS	DESCRIPTION	PRIX / PRICE
	E513		BLIND	177 €
	E516	1	PETIT BOIS / TRANSOM	262 €
	E516	1	GRILLE / SAFETY	388 €
Aluminium Couvre/Covering (mdf 4 / 6mm) 90x210cm				95 €
Aluminium Couvre/Covering (mdf 4 / 6mm)100x225cm				120 €

	CODE	VERRE / GLASS	DESCRIPTION	PRIX / PRICE
	E532		BLIND	177 €
	E533	1	PETIT BOIS / TRANSOM	262 €
	E533	1	GRILLE / SAFETY	410 €
Aluminium Couvre/Covering (mdf 4 / 6mm) 90x210cm				95 €
Aluminium Couvre/Covering (mdf 4 / 6mm)100x225cm				120 €

E2000 Series Classic

**Panneau Aluminium Presses
Aluminium pressed panel**

CODE	VERRE / GLASS	DESCRIPTION	PRIX / PRICE
E534		BLIND	177 €
E535	1	PETIT BOIS / TRANSOM	262 €
E535	1	GRILLE / SAFETY	388 €



Aluminium Couvre/Covering (mdf 4 / 6mm) 90x210cm **95 €**
Aluminium Couvre/Covering (mdf 4 / 6mm)100x225cm **120 €**

CODE	VERRE / GLASS	DESCRIPTION	PRIX / PRICE
E550		BLIND	177 €
E551	2	PETIT BOIS / TRANSOM	290 €
E551	2	GRILLE / SAFETY	374 €
E551	2	KARAVOLO	374 €
E551	2	DECO	381 €



Aluminium Couvre/Covering (mdf 4 / 6mm) 90x210cm **95 €**
Aluminium Couvre/Covering (mdf 4 / 6mm)100x225cm **120 €**

CODE	VERRE / GLASS	DESCRIPTION	PRIX / PRICE
E536		BLIND	177 €
E537	4	PETIT BOIS / TRANSOM	290 €
E537	4	GRILLE / SAFETY	417 €



Aluminium Couvre/Covering (mdf 4 / 6mm) 90x210cm **95 €**
Aluminium Couvre/Covering (mdf 4 / 6mm)100x225cm **120 €**

CODE	VERRE / GLASS	DESCRIPTION	PRIX / PRICE
E552		BLIND	177 €
E553	1	PETIT BOIS / TRANSOM	311 €
E553	1	DECO	431 €
E553	1	GRILLE / SAFETY	388 €

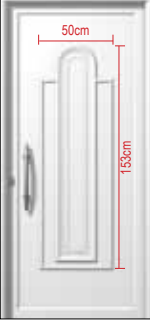

Aluminium Couvre/Covering (mdf 4 / 6mm) 90x210cm **95 €**
Aluminium Couvre/Covering (mdf 4 / 6mm)100x225cm **120 €**

CODE	VERRE / GLASS	DESCRIPTION	PRIX / PRICE
E540		BLIND	177 €
E541	1	PETIT BOIS / TRANSOM	262 €
E541	1	GRILLE / SAFETY	388 €



Aluminium Couvre/Covering (mdf 4 / 6mm) 90x210cm **95 €**
Aluminium Couvre/Covering (mdf 4 / 6mm)100x225cm **120 €**

CODE	VERRE / GLASS	DESCRIPTION	PRIX / PRICE
E556		BLIND	177 €
E557	1	PETIT BOIS / TRANSOM	232 €
E557	1	GRILLE / SAFETY	303 €
E558	3	PETIT BOIS / TRANSOM	255 €
E559	5	PETIT BOIS / TRANSOM	296 €



Aluminium Couvre/Covering (mdf 4 / 6mm) 90x210cm **95 €**
Aluminium Couvre/Covering (mdf 4 / 6mm)100x225cm **120 €**

CODE	VERRE / GLASS	DESCRIPTION	PRIX / PRICE
E545		BLIND	177 €
E546	1	PETIT BOIS / TRANSOM	262 €
E546	1	FUSED	473 €





Aluminium Couvre/Covering (mdf 4 / 6mm) 90x210cm **95 €**
Aluminium Couvre/Covering (mdf 4 / 6mm)100x225cm **120 €**

E2000 Series Classic

Panneau Aluminium Presses
Aluminium pressed panel

	CODE	VERRE / GLASS	DESCRIPTION	PRIX / PRICE
	E560		BLIND	177 €
	E561	2	VERRE / GLASS	331 €
Aluminium Couvre/Covering (mdf 4 / 6mm) 90x210cm				95 €
Aluminium Couvre/Covering (mdf 4 / 6mm)100x225cm				120 €

	CODE	VERRE / GLASS	DESCRIPTION	PRIX / PRICE
	E586		BLIND	177 €
	E587	1	PETIT BOIS / TRANSOM	268 €
Aluminium Couvre/Covering (mdf 4 / 6mm) 90x210cm				95 €
Aluminium Couvre/Covering (mdf 4 / 6mm)100x225cm				120 €

	CODE	VERRE / GLASS	DESCRIPTION	PRIX / PRICE
	E564		BLIND	177 €
	E565	1	GRILLE / SAFETY	368 €
Aluminium Couvre/Covering (mdf 4 / 6mm) 90x210cm				95 €
Aluminium Couvre/Covering (mdf 4 / 6mm)100x225cm				120 €

	CODE	VERRE / GLASS	DESCRIPTION	PRIX / PRICE
	E700		BLIND	177 €
	E701	1	PETIT BOIS / TRANSOM	232 €
	E701	1	FUSED	318 €
	E702	2	PETIT BOIS / TRANSOM	284 €
	E702	2	FUSED	459 €
Aluminium Couvre/Covering (mdf 4 / 6mm) 90x210cm				95 €
Aluminium Couvre/Covering (mdf 4 / 6mm)100x225cm				120 €

	CODE	VERRE / GLASS	DESCRIPTION	PRIX / PRICE
	E566		BLIND	177 €
	E567	1	PETIT BOIS / TRANSOM	232 €
	E567	1	GRILLE / SAFETY	303 €
	E569	5	PETIT BOIS / TRANSOM	290 €
	E569	5	GRILLE / SAFETY	444 €
	E571	9	PETIT BOIS / TRANSOM	331 €
E571	9	GRILLE / SAFETY	473 €	
Aluminium Couvre/Covering (mdf 4 / 6mm) 90x210cm				95 €
Aluminium Couvre/Covering (mdf 4 / 6mm)100x225cm				120 €

	CODE	VERRE / GLASS	DESCRIPTION	PRIX / PRICE
	E710		BLIND	177 €
	E711	1	PETIT BOIS / TRANSOM	268 €
	E711	1	GRILLE / SAFETY	388 €
Aluminium Couvre/Covering (mdf 4 / 6mm) 90x210cm				95 €
Aluminium Couvre/Covering (mdf 4 / 6mm)100x225cm				120 €

	CODE	VERRE / GLASS	DESCRIPTION	PRIX / PRICE
	E580		BLIND	177 €
	E581	1	PETIT BOIS / TRANSOM	232 €
	E583	3	PETIT BOIS / TRANSOM	247 €
	E585	5	PETIT BOIS / TRANSOM	275 €
Aluminium Couvre/Covering (mdf 4 / 6mm) 90x210cm				95 €
Aluminium Couvre/Covering (mdf 4 / 6mm)100x225cm				120 €

	CODE	VERRE / GLASS	DESCRIPTION	PRIX / PRICE
	E712		BLIND	177 €
	E713	1	PETIT BOIS / TRANSOM	268 €
Aluminium Couvre/Covering (mdf 4 / 6mm) 90x210cm				95 €
Aluminium Couvre/Covering (mdf 4 / 6mm)100x225cm				120 €

E2000 Series Classic

Panneau Aluminium Presses
Aluminium pressed panel

CODE	VERRE / GLASS	DESCRIPTION	PRIX / PRICE
E720		BLIND	177 €
E721	1	PETIT BOIS / TRANSOM	247 €
E721	1	GRILLE / SAFETY	303 €
E722	2	PETIT BOIS / TRANSOM	284 €
E722	2	GRILLE / SAFETY	374 €
E723	3	PETIT BOIS / TRANSOM	311 €
E723	3	GRILLE / SAFETY	431 €
Aluminium Couvre/Covering (mdf 4 / 6mm) 90x210cm			95 €
Aluminium Couvre/Covering (mdf 4 / 6mm)100x225cm			120 €

CODE	VERRE / GLASS	DESCRIPTION	PRIX / PRICE
E750		BLIND	177 €
E751	1	DECO	331 €
Aluminium Couvre/Covering (mdf 4 / 6mm) 90x210cm			95 €
Aluminium Couvre/Covering (mdf 4 / 6mm)100x225cm			120 €

CODE	VERRE / GLASS	DESCRIPTION	PRIX / PRICE
E725		BLIND	177 €
E726	1	PETIT BOIS / TRANSOM	232 €
E726	1	GRILLE / SAFETY	303 €
E727	2	PETIT BOIS / TRANSOM	311 €
E727	2	FUSED	444 €
E727	2	GRILLE / SAFETY	388 €
Aluminium Couvre/Covering (mdf 4 / 6mm) 90x210cm			95 €
Aluminium Couvre/Covering (mdf 4 / 6mm)100x225cm			120 €

CODE	VERRE / GLASS	DESCRIPTION	PRIX / PRICE
E760		BLIND	177 €
E761	1	PETIT BOIS / TRANSOM	268 €
E761	1	GRILLE / SAFETY	374 €
Aluminium Couvre/Covering (mdf 4 / 6mm) 90x210cm			95 €
Aluminium Couvre/Covering (mdf 4 / 6mm)100x225cm			120 €

CODE	VERRE / GLASS	DESCRIPTION	PRIX / PRICE
E728		BLIND	177 €
E729	1	PETIT BOIS / TRANSOM	247 €
E729	1	GRILLE / SAFETY	311 €
E730	2	PETIT BOIS / TRANSOM	284 €
E730	2	GRILLE / SAFETY	374 €
E731	3	PETIT BOIS / TRANSOM	311 €
E731	3	GRILLE / SAFETY	431 €
Aluminium Couvre/Covering (mdf 4 / 6mm) 90x210cm			95 €
Aluminium Couvre/Covering (mdf 4 / 6mm)100x225cm			120 €

CODE	VERRE / GLASS	DESCRIPTION	PRIX / PRICE
E770		BLIND	177 €
E771	1	PETIT BOIS / TRANSOM	262 €
E771	1	GRILLE / SAFETY	388 €
Aluminium Couvre/Covering (mdf 4 / 6mm) 90x210cm			95 €
Aluminium Couvre/Covering (mdf 4 / 6mm)100x225cm			120 €

CODE	VERRE / GLASS	DESCRIPTION	PRIX / PRICE
E740		BLIND	177 €
E741	1	PETIT BOIS / TRANSOM	275 €
E741	1	GRILLE / SAFETY	388 €
Aluminium Couvre/Covering (mdf 4 / 6mm) 90x210cm			95 €
Aluminium Couvre/Covering (mdf 4 / 6mm)100x225cm			120 €

CODE	VERRE / GLASS	DESCRIPTION	PRIX / PRICE
E790		BLIND	177 €
E791	1	PETIT BOIS / TRANSOM	232 €
E791	1	GRILLE / SAFETY	303 €
E792	2	PETIT BOIS / TRANSOM	275 €
E792	2	GRILLE / SAFETY	361 €
Aluminium Couvre/Covering (mdf 4 / 6mm) 90x210cm			95 €
Aluminium Couvre/Covering (mdf 4 / 6mm)100x225cm			120 €

E2000 Series Classic

Panneau Aluminium Presses
Aluminium pressed panel



E780



E781



E782

CODE	DESCRIPTION	PRIX / PRICE
E780	BLIND	177 €
E781	BLIND	177 €
E782	BLIND	177 €
Aluminium Couvre/Covering (mdf 4 / 6mm) 90x210cm		95 €
Aluminium Couvre/Covering (mdf 4 / 6mm)100x225cm		120 €



E783



E785

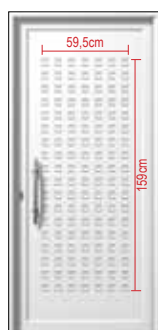

E789

CODE	DESCRIPTION	PRIX / PRICE
E783	BLIND	177 €
E785	BLIND	177 €
E789	BLIND	177 €
Aluminium Couvre/Covering (mdf 4 / 6mm) 90x210cm		95 €
Aluminium Couvre/Covering (mdf 4 / 6mm)100x225cm		120 €

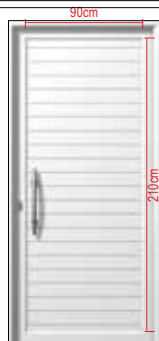

E714

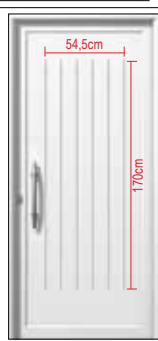

E784

CODE	DESCRIPTION	PRIX / PRICE
E784	BLIND	177 €
E714	BLIND	177 €
Aluminium Couvre/Covering (mdf 4 / 6mm) 90x210cm		95 €
Aluminium Couvre/Covering (mdf 4 / 6mm)100x225cm		120 €

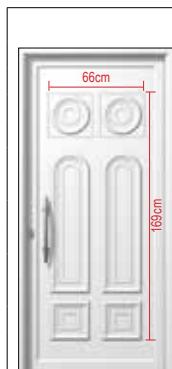

CODE	VERRE / GLASS	DESCRIPTION	PRIX / PRICE
E200		BLIND	177 €
E202	2	PETIT BOIS	290 €
E202	2	GRILLE / SAFETY	354 €
E202	2	VITRO	431 €
E204	4	PETIT BOIS	354 €
E204	4	GRILLE / SAFETY	473 €
E204	4	VITRO	698 €

Aluminium Couvre/Covering (mdf 4 / 6mm) 90x210cm | 95 €
Aluminium Couvre/Covering (mdf 4 / 6mm)100x225cm | 120 €



CODE	VERRE / GLASS	DESCRIPTION	PRIX / PRICE
E803		BLIND	177 €
E807	1	PETIT BOIS	232 €
E807	1	GRILLE / SAFETY	303 €
E807	1	FUSED	318 €
E807	1	DECO	311 €
E808	3	PETIT BOIS / TRANSOM	268 €
E809	5	PETIT BOIS / TRANSOM	290 €
E817	7	PETIT BOIS / TRANSOM	311 €
E818	9	PETIT BOIS / TRANSOM	331 €

Aluminium Couvre/Covering (mdf 4 / 6mm) 90x210cm | 95 €
Aluminium Couvre/Covering (mdf 4 / 6mm)100x225cm | 120 €



CODE	VERRE / GLASS	DESCRIPTION	PRIX / PRICE
E812		BLIND	177 €
E814	2	PETIT BOIS / TRANSOM	275 €
E814	2	GRILLE / SAFETY	346 €

Aluminium Couvre/Covering (mdf 4 / 6mm) 90x210cm | 95 €
Aluminium Couvre/Covering (mdf 4 / 6mm)100x225cm | 120 €



CODE	VERRE / GLASS	DESCRIPTION	PRIX / PRICE
E820		BLIND	177 €
E822	2	PETIT BOIS / TRANSOM	247 €
E822	2	GRILLE / SAFETY	290 €
E824	4	PETIT BOIS / TRANSOM	268 €
E824	4	GRILLE / SAFETY	325 €
E826	6	PETIT BOIS / TRANSOM	296 €
E826	6	GRILLE / SAFETY	374 €
E828	8	PETIT BOIS / TRANSOM	318 €
E829	10	PETIT BOIS / TRANSOM	346 €
E829	10	GRILLE / SAFETY	465 €

Aluminium Couvre/Covering (mdf 4 / 6mm) 90x210cm | 95 €
Aluminium Couvre/Covering (mdf 4 / 6mm)100x225cm | 120 €

E2000 Series Classic

**Panneau Aluminium Presses
Aluminium pressed panel**



CODE	VERRE / GLASS	DESCRIPTION	PRIX / PRICE
E845		BLIND	177 €
E846	1	PETIT BOIS / TRANSOM	268 €
E846	1	GRILLE / SAFETY	473 €

Aluminium Couvre/Covering (mdf 4 / 6mm) 90x210cm | **95 €**
Aluminium Couvre/Covering (mdf 4 / 6mm)100x225cm | **120 €**



CODE	VERRE / GLASS	DESCRIPTION	PRIX / PRICE
E870		BLIND	177 €
E871	1	PETIT BOIS / TRANSOM	284 €
E871	1	GRILLE / SAFETY	361 €
E871	1	DECO	431 €

Aluminium Couvre/Covering (mdf 4 / 6mm) 90x210cm | **95 €**
Aluminium Couvre/Covering (mdf 4 / 6mm)100x225cm | **120 €**



CODE	VERRE / GLASS	DESCRIPTION	PRIX / PRICE
E847		BLIND	177 €
E848	1	PETIT BOIS / TRANSOM	268 €
E848	1	GRILLE / SAFETY	473 €

Aluminium Couvre/Covering (mdf 4 / 6mm) 90x210cm | **95 €**
Aluminium Couvre/Covering (mdf 4 / 6mm)100x225cm | **120 €**



CODE	VERRE / GLASS	DESCRIPTION	PRIX / PRICE
E873		BLIND	177 €
E874	1	PETIT BOIS / TRANSOM	284 €
E874	1	GRILLE / SAFETY	361 €
E874	1	DECO	431 €

Aluminium Couvre/Covering (mdf 4 / 6mm) 90x210cm | **95 €**
Aluminium Couvre/Covering (mdf 4 / 6mm)100x225cm | **120 €**



CODE	VERRE / GLASS	DESCRIPTION	PRIX / PRICE
E850		BLIND	177 €
E851	1	PETIT BOIS / TRANSOM	232 €
E851	1	GRILLE / SAFETY	296 €
E851	1	DECO	311 €
E853	3	PETIT BOIS / TRANSOM	331 €

Aluminium Couvre/Covering (mdf 4 / 6mm) 90x210cm | **95 €**
Aluminium Couvre/Covering (mdf 4 / 6mm)100x225cm | **120 €**

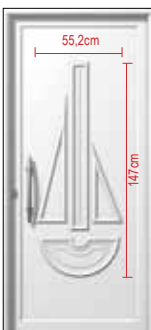

CODE	VERRE / GLASS	DESCRIPTION	PRIX / PRICE
E875		BLIND	177 €
E876	1	VERRE / GLASS	268 €
E878	4	VERRE / GLASS	331 €

Aluminium Couvre/Covering (mdf 4 / 6mm) 90x210cm | **95 €**
Aluminium Couvre/Covering (mdf 4 / 6mm)100x225cm | **120 €**



CODE	VERRE / GLASS	DESCRIPTION	PRIX / PRICE
E860		BLIND	177 €
E864	4	PETIT BOIS / TRANSOM	318 €
E864	4	GRILLE / SAFETY	698 €

Aluminium Couvre/Covering (mdf 4 / 6mm) 90x210cm | **95 €**
Aluminium Couvre/Covering (mdf 4 / 6mm)100x225cm | **120 €**





CODE	VERRE / GLASS	DESCRIPTION	PRIX / PRICE
E880		BLIND	177 €
E881	1	PETIT BOIS / TRANSOM	255 €
E881	1	GRILLE / SAFETY	325 €
E881	1	DECO	374 €

Aluminium Couvre/Covering (mdf 4 / 6mm) 90x210cm | **95 €**
Aluminium Couvre/Covering (mdf 4 / 6mm)100x225cm | **120 €**

E2000 Series Classic

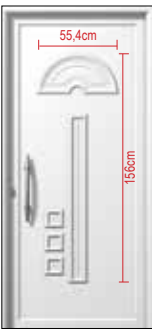
**Panneau Aluminium Presses
Aluminium pressed panel**

	CODE	VERRE / GLASS	DESCRIPTION	PRIX / PRICE
	E884		BLIND	177 €
	E885	1	VERRE / GLASS	228 €
	E886	2	VERRE / GLASS	290 €
Aluminium Couvre/Covering (mdf 4 / 6mm) 90x210cm				95 €
Aluminium Couvre/Covering (mdf 4 / 6mm)100x225cm				120 €

	CODE	VERRE / GLASS	DESCRIPTION	PRIX / PRICE
	E902		BLIND	177 €
	E900	2	PETIT BOIS / TRANSOM	290 €
	E900	2	GRILLE / SAFETY	444 €
	E900	2	KARAVOLO	444 €
	E900	2	DECO	381 €
Aluminium Couvre/Covering (mdf 4 / 6mm) 90x210cm				95 €
Aluminium Couvre/Covering (mdf 4 / 6mm)100x225cm				120 €

	CODE	VERRE / GLASS	DESCRIPTION	PRIX / PRICE
	E890		BLIND	177 €
Aluminium Couvre/Covering (mdf 4 / 6mm) 90x210cm				95 €
Aluminium Couvre/Covering (mdf 4 / 6mm)100x225cm				120 €

	CODE	VERRE / GLASS	DESCRIPTION	PRIX / PRICE
	E910		BLIND	177 €
	E911	1	PETIT BOIS / TRANSOM	268 €
E911	1	GRILLE / SAFETY	388 €	
Aluminium Couvre/Covering (mdf 4 / 6mm) 90x210cm				95 €
Aluminium Couvre/Covering (mdf 4 / 6mm)100x225cm				120 €

	CODE	VERRE / GLASS	DESCRIPTION	PRIX / PRICE
	E895		BLIND	177 €
	E896	2	PETIT BOIS / TRANSOM	275 €
	E899	4	PETIT BOIS / TRANSOM	361 €
Aluminium Couvre/Covering (mdf 4 / 6mm) 90x210cm				95 €
Aluminium Couvre/Covering (mdf 4 / 6mm)100x225cm				120 €

	CODE	VERRE / GLASS	DESCRIPTION	PRIX / PRICE
	E922		BLIND	177 €
	E923	1	VERRE / GLASS	318 €
Aluminium Couvre/Covering (mdf 4 / 6mm) 90x210cm				95 €
Aluminium Couvre/Covering (mdf 4 / 6mm)100x225cm				120 €

	CODE	VERRE / GLASS	DESCRIPTION	PRIX / PRICE
	E897		BLIND	177 €
	E898	2	PETIT BOIS / TRANSOM	268 €
Aluminium Couvre/Covering (mdf 4 / 6mm) 90x210cm				95 €
Aluminium Couvre/Covering (mdf 4 / 6mm)100x225cm				120 €

	CODE	VERRE / GLASS	DESCRIPTION	PRIX / PRICE
	E926		BLIND	177 €
	E928	1	PETIT BOIS / TRANSOM	268 €
	E928	1	GRILLE / SAFETY	388 €
Aluminium Couvre/Covering (mdf 4 / 6mm) 90x210cm				95 €
Aluminium Couvre/Covering (mdf 4 / 6mm)100x225cm				120 €

E2000 Series Classic

**Panneau Aluminium Presses
Aluminium pressed panel**

CODE	VERRE / GLASS	DESCRIPTION	PRIX / PRICE
E941		BLIND	177 €
E943	2	PETIT BOIS / TRANSOM	290 €
E943	2	GRILLE / SAFETY	444 €



Aluminium Couvre/Covering (mdf 4 / 6mm) 90x210cm	95 €
Aluminium Couvre/Covering (mdf 4 / 6mm)100x225cm	120 €

CODE	VERRE / GLASS	DESCRIPTION	PRIX / PRICE
E990		BLIND	177 €
E992	2	PETIT BOIS / TRANSOM	228 €
E994	4	PETIT BOIS / TRANSOM	255 €
E996	6	PETIT BOIS / TRANSOM	296 €



Aluminium Couvre/Covering (mdf 4 / 6mm) 90x210cm	95 €
Aluminium Couvre/Covering (mdf 4 / 6mm)100x225cm	120 €

CODE	VERRE / GLASS	DESCRIPTION	PRIX / PRICE
E951		BLIND	177 €
E952	2	PETIT BOIS / TRANSOM	262 €
E954	4	PETIT BOIS / TRANSOM	325 €



Aluminium Couvre/Covering (mdf 4 / 6mm) 90x210cm	95 €
Aluminium Couvre/Covering (mdf 4 / 6mm)100x225cm	120 €

CODE	VERRE / GLASS	DESCRIPTION	PRIX / PRICE
E504		BLIND	120 €
E506	1	PETIT BOIS / TRANSOM	182 €
E506	1	GRILLE / SAFETY	223 €
E506	1	DECO	238 €
E506	1	KARAVOLO	223 €



E588		BLIND	116 €
E589	1	PETIT BOIS / TRANSOM	182 €

CODE	VERRE / GLASS	DESCRIPTION	PRIX / PRICE
E957		BLIND	177 €
E958	1	VERRE / GLASS	290 €
E959	2	VERRE / GLASS	318 €
E960	3	VERRE / GLASS	331 €
E960	3	VITRO	431 €



Aluminium Couvre/Covering (mdf 4 / 6mm) 90x210cm	95 €
Aluminium Couvre/Covering (mdf 4 / 6mm)100x225cm	120 €

CODE	VERRE / GLASS	DESCRIPTION	PRIX / PRICE
E520		BLIND	120 €
E521	1	PETIT BOIS / TRANSOM	152 €
E521	1	GRILLE / SAFETY	167 €
E522	2	PETIT BOIS / TRANSOM	159 €
E522	2	GRILLE / SAFETY	209 €
E523	3	PETIT BOIS / TRANSOM	167 €
E523	3	GRILLE / SAFETY	245 €
E524	4	PETIT BOIS / TRANSOM	187 €
E524	4	GRILLE / SAFETY	280 €
E526	5	PETIT BOIS / TRANSOM	202 €
E526	5	GRILLE / SAFETY	316 €



CODE	VERRE / GLASS	DESCRIPTION	PRIX / PRICE
E982		BLIND	177 €
E981	1	PETIT BOIS / TRANSOM	232 €
E981	1	KARAVOLO	303 €
E983	3	PETIT BOIS / TRANSOM	255 €
E983	3	GRILLE / SAFETY	417 €
E983	3	FUSED	473 €
E983	3	DECO	354 €
E983	3	KARAVOLO	417 €
E985	5	KARAVOLO	529 €
E985	5	PETIT BOIS / TRANSOM	296 €
E985	5	GRILLE / SAFETY	529 €



Aluminium Couvre/Covering (mdf 4 / 6mm) 90x210cm	95 €
Aluminium Couvre/Covering (mdf 4 / 6mm)100x225cm	120 €

CODE	VERRE / GLASS	DESCRIPTION	PRIX / PRICE
E554		BLIND	120 €
E555	1	PETIT BOIS / TRANSOM	174 €
E555	1	GRILLE / SAFETY	223 €



E2000 Series Classic

Panneau Aluminium Presses
Aluminium pressed panel

CODE	VERRE / GLASS	DESCRIPTION	PRIX / PRICE
E562		BLIND	120 €
E563	3	VERRE / GLASS	167 €



CODE	VERRE / GLASS	DESCRIPTION	PRIX / PRICE
E800		BLIND	120 €
E801	1	PETIT BOIS / TRANSOM	152 €
E801	1	FUSED	194 €
E801	1	DECO	167 €
E802	2	PETIT BOIS / TRANSOM	159 €
E804	3	PETIT BOIS / TRANSOM	187 €
E806	5	PETIT BOIS / TRANSOM	245 €



CODE	VERRE / GLASS	DESCRIPTION	PRIX / PRICE
E572		BLIND	120 €
E573	1	PETIT BOIS / TRANSOM	152 €
E575	3	PETIT BOIS / TRANSOM	187 €
E577	5	PETIT BOIS / TRANSOM	209 €



CODE	VERRE / GLASS	DESCRIPTION	PRIX / PRICE
E854 L		BLIND	120 €
E855 L	1	PETIT BOIS / TRANSOM	152 €
E855 L	1	DECO	182 €
E854 R		BLIND	120 €
E855 R	1	PETIT BOIS / TRANSOM	152 €
E855 R	1	DECO	182 €

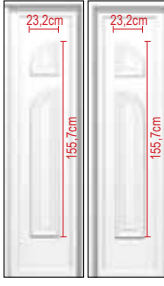

CODE	VERRE / GLASS	DESCRIPTION	PRIX / PRICE
E590		BLIND	120 €
E591	1	PETIT BOIS / TRANSOM	146 €
E592	2	PETIT BOIS / TRANSOM	167 €
E593	3	PETIT BOIS / TRANSOM	187 €



CODE	VERRE / GLASS	DESCRIPTION	PRIX / PRICE
E892		BLIND	120 €
E893	1	PETIT BOIS / TRANSOM	159 €
E894	2	PETIT BOIS / TRANSOM	182 €



CODE	VERRE / GLASS	DESCRIPTION	PRIX / PRICE
E762		BLIND	120 €
E763	1	PETIT BOIS / TRANSOM	182 €
E810		BLIND	120 €
E811	1	PETIT BOIS / TRANSOM	159 €
E811	1	GRILLE / SAFETY	194 €



CODE	VERRE / GLASS	DESCRIPTION	PRIX / PRICE
E903		BLIND	120 €
E905	1	PETIT BOIS / TRANSOM	182 €
E905	1	GRILLE / SAFETY	329 €
E905	1	DECO	223 €
E905	1	KARAVOLO	329 €
E906	2	PETIT BOIS / TRANSOM	187 €



E2000 Series Classic

Panneau Aluminium Presses
Aluminium pressed panel



CODE	VERRE / GLASS	DESCRIPTION	PRIX / PRICE
E907		BLIND	120 €
E908	1	PETIT BOIS / TRANSOM	187 €
E908	1	DECO	323 €
E908	1	GRILLE / SAFETY	266 €



CODE	VERRE / GLASS	DESCRIPTION	PRIX / PRICE
E210		BLIND	120 €
E211	1	PETIT BOIS / TRANSOM	152 €
E211	1	GRILLE / SAFETY	182 €
E211	1	VITRO	215 €
E212	2	PETIT BOIS / TRANSOM	182 €
E212	2	GRILLE / SAFETY	245 €
E212	2	VITRO	456 €



CODE	VERRE / GLASS	DESCRIPTION	PRIX / PRICE
E933		BLIND	120 €
E934	1	PETIT BOIS / TRANSOM	182 €
E934	1	GRILLE / SAFETY	329 €



CODE	VERRE / GLASS	DESCRIPTION	PRIX / PRICE
E856		BLIND	120 €
E857	1	PETIT BOIS / TRANSOM	146 €
E858	2	PETIT BOIS / TRANSOM	167 €
E859	3	PETIT BOIS / TRANSOM	187 €



CODE	VERRE / GLASS	DESCRIPTION	PRIX / PRICE
E986		BLIND	120 €
E987	1	PETIT BOIS / TRANSOM	146 €
E987	1	FUSED	187 €
E988	2	PETIT BOIS / TRANSOM	167 €
E988	2	GRILLE / SAFETY	245 €
E988	2	FUSED	280 €
E988	2	KARAVOLO	245 €
E988	2	DECO	230 €
E989	3	PETIT BOIS / TRANSOM	187 €



CODE	VERRE / GLASS	DESCRIPTION	PRIX / PRICE
E865		BLIND	120 €
E866	1	PETIT BOIS / TRANSOM	182 €
E866	1	DECO	266 €

E2000 / P 6000 / INOX300 Series

SURCHARGE DIMENSIONS

- Panneau Lateral Blind 90x210cm +90 € du prix catalogue
- Panneau Lateral 90x210cm avec vitrage +90 € du prix catalogue
- Surcharge pour vitrage Triplex +20 € (petit) et +35 € (grand)

* Dimensions Standard: Panneau total 90x210cm / Panneau Lateral 45x210cm

EXTRA DIMENSION CHARGES

- Blind side panel in 90x210cm (w) in price of full.
- Side panel with in 90x210cm (w) with glasses+90 € in price of catalogue.
- Extra charges per triplex based on the plan of the aluminium panel.

* Standard dimensions: FULL PANEL 90x210cm / SIDE PANEL 45x210cm

CHARGES ADDITIONNELS / ADDITIONAL CHARGES

LARGEUR WIDTH (W)	HAUTEUR HEIGHT (H)	CHARGE
45 cm	225 cm	+ 15 €
100 cm	225 cm	+ 30 €

HDS ULTRA PLUS

DIMENSIONS	CHARGE
45x210 cm	+ 26 €
90x210 cm	+ 52 €
45x225 cm	+ 30 €
100x225 cm	+ 62 €

COULEUR EXTRA

- BLANC RAL 9016 - sans charge
- Peinture chez-sous traitant (selon demande)

CHARGES IN COLOR

1. IN-HOUSE Painting - RAL 9016 WHITE: no charge
2. OUTSOURCING painting - Outsourced basis pricelist (upon request)

CHARGES COLORISATION DANS UNITE PEINTURE ALUMINCO CHARGES FOR ALUMINCO INHOUSE PAINTING

PANNEAU TOTAL / FULL PANEL	
RAL	55 €
SPECIAL	75 €
IMITATION BOIS / WOOD	90 €
RENOLIT PVC FOIL	90 €
PANNEAU LATERAL / HALF PANEL	
RAL	35 €
SPECIAL	45 €
IMITATION BOIS / WOOD	50 €
RENOLIT PVC FOIL	50 €
COUVRE D' ALUMINIUM / ALUMINIUM COVERING	
RAL	27,50 €
SPECIAL	37,50 €
IMITATIONS BOIS / WOOD	45 €

P6000 Series Heavy Duty

	CODE	VERRE / GLASS	DESCRIPTION	PRIX / PRICE
	P6100		BLIND	246 €
	P6101	1	PETIT BOIS / TRANSOM	344 €
	P6101	1	GRILLE / SAFETY	446 €
Aluminium Couvre/Covering (mdf 4 / 6mm) 90x210cm				130 €
Aluminium Couvre/Covering (mdf 4 / 6mm)100x225cm				155 €
SURCHARGE DE VERRE triplex - cathedral CHARGES FOR TRIPLEX GLASSES - CATHEDRAL				20 €/pc.

	CODE	VERRE / GLASS	DESCRIPTION	PRIX / PRICE
	P6140		BLIND	246 €
	P6141	1	PETIT BOIS / TRANSOM	311 €
	P6142	2	PETIT BOIS / TRANSOM	371 €
Aluminium Couvre/Covering (mdf 4 / 6mm) 90x210cm				130 €
Aluminium Couvre/Covering (mdf 4 / 6mm)100x225cm				155 €
SURCHARGE DE VERRE triplex - cathedral CHARGES FOR TRIPLEX GLASSES - CATHEDRAL				15 €/pc.

	CODE	VERRE / GLASS	DESCRIPTION	PRIX / PRICE
	P6110		BLIND	246 €
	P6111	1	PETIT BOIS / TRANSOM	344 €
	P6111	1	GRILLE / SAFETY	494 €
Aluminium Couvre/Covering (mdf 4 / 6mm) 90x210cm				130 €
Aluminium Couvre/Covering (mdf 4 / 6mm)100x225cm				155 €
SURCHARGE DE VERRE triplex - cathedral CHARGES FOR TRIPLEX GLASSES - CATHEDRAL				20 €/pc.

	CODE	VERRE / GLASS	DESCRIPTION	PRIX / PRICE
	P6150		BLIND	246 €
	P6151	1	PETIT BOIS / TRANSOM	331 €
	P6151	1	GRILLE / SAFETY	392 €
	P6152	2	PETIT BOIS / TRANSOM	365 €
	P6152	2	GRILLE / SAFETY	446 €
	P6153	3	PETIT BOIS / TRANSOM	398 €
	P6153	3	GRILLE / SAFETY	500 €
Aluminium Couvre/Covering (mdf 4 / 6mm) 90x210cm				130 €
Aluminium Couvre/Covering (mdf 4 / 6mm)100x225cm				155 €
SURCHARGE DE VERRE triplex - cathedral CHARGES FOR TRIPLEX GLASSES - CATHEDRAL				15 €/pc.

	CODE	VERRE / GLASS	DESCRIPTION	PRIX / PRICE
	P 6120		BLIND	246 €
	P 6121	1	PETIT BOIS / TRANSOM	344 €
	P 6121	1	GRILLE / SAFETY	494 €
Aluminium Couvre/Covering (mdf 4 / 6mm) 90x210cm				130 €
Aluminium Couvre/Covering (mdf 4 / 6mm)100x225cm				155 €
SURCHARGE DE VERRE triplex - cathedral CHARGES FOR TRIPLEX GLASSES - CATHEDRAL				20 €/pc.

	CODE	VERRE / GLASS	DESCRIPTION	PRIX / PRICE
	P6160		BLIND	246 €
	P6161	1	PETIT BOIS / TRANSOM	358 €
	P6161	1	GRILLE / SAFETY	527 €
Aluminium Couvre/Covering (mdf 4 / 6mm) 90x210cm				130 €
Aluminium Couvre/Covering (mdf 4 / 6mm)100x225cm				155 €
SURCHARGE DE VERRE triplex - cathedral CHARGES FOR TRIPLEX GLASSES - CATHEDRAL				20 €/pc.

	CODE	VERRE / GLASS	DESCRIPTION	PRIX / PRICE
	P6130		BLIND	246 €
	P6131	1	PETIT BOIS / TRANSOM	311 €
	P6133	3	PETIT BOIS / TRANSOM	353 €
	P6135	5	PETIT BOIS / TRANSOM	380 €
Aluminium Couvre/Covering (mdf 4 / 6mm) 90x210cm				130 €
Aluminium Couvre/Covering (mdf 4 / 6mm)100x225cm				155 €
SURCHARGE DE VERRE triplex - cathedral CHARGES FOR TRIPLEX GLASSES - CATHEDRAL				10 €/pc.

	CODE	VERRE / GLASS	DESCRIPTION	PRIX / PRICE
	P6170		BLIND	246 €
	P6171	1	PETIT BOIS / TRANSOM	344 €
	P6171	1	GRILLE / SAFETY	473 €
Aluminium Couvre/Covering (mdf 4 / 6mm) 90x210cm				130 €
Aluminium Couvre/Covering (mdf 4 / 6mm)100x225cm				155 €
SURCHARGE DE VERRE triplex - cathedral CHARGES FOR TRIPLEX GLASSES - CATHEDRAL				20 €/pc.

P6000 Series Heavy Duty

**Panneau Aluminium Presses
à usage intensif 1.2 mm
Heavy duty aluminium
pressed panel 1.2 mm**



CODE	VERRE / GLASS	DESCRIPTION	PRIX / PRICE
P6180		BLIND	246 €
P6182	2	PETIT BOIS / TRANSOM	358 €
Aluminium Couvre/Covering (mdf 4 / 6mm) 90x210cm			130 €
Aluminium Couvre/Covering (mdf 4 / 6mm)100x225cm			155 €
SURCHARGE DE VERRE triplex - cathedral CHARGES FOR TRIPLEX GLASSES - CATHEDRAL			10 €/pc.



CODE	VERRE / GLASS	DESCRIPTION	PRIX / PRICE
P6220		BLIND	246 €
P6221	1	PETIT BOIS / TRANSOM	358 €
P6221	1	GRILLE / SAFETY	446 €
Aluminium Couvre/Covering (mdf 4 / 6mm) 90x210cm			130 €
Aluminium Couvre/Covering (mdf 4 / 6mm)100x225cm			155 €
SURCHARGE DE VERRE triplex - cathedral CHARGES FOR TRIPLEX GLASSES - CATHEDRAL			20 €/pc.



CODE	VERRE / GLASS	DESCRIPTION	PRIX / PRICE
P6190		BLIND	246 €
P6196	6	PETIT BOIS / TRANSOM	385 €
P6196	6	GRILLE / SAFETY	473 €
P6199	10	PETIT BOIS / TRANSOM	440 €
P6199	10	GRILLE / SAFETY	574 €
Aluminium Couvre/Covering (mdf 4 / 6mm) 90x210cm			130 €
Aluminium Couvre/Covering (mdf 4 / 6mm)100x225cm			155 €
SURCHARGE DE VERRE triplex - cathedral CHARGES FOR TRIPLEX GLASSES - CATHEDRAL			5 €/pc.



CODE	VERRE / GLASS	DESCRIPTION	PRIX / PRICE
P6230		BLIND	246 €
P6231	1	PETIT BOIS / TRANSOM	358 €
P6231	1	GRILLE / SAFETY	418 €
Aluminium Couvre/Covering (mdf 4 / 6mm) 90x210cm			130 €
Aluminium Couvre/Covering (mdf 4 / 6mm)100x225cm			155 €
SURCHARGE DE VERRE triplex - cathedral CHARGES FOR TRIPLEX GLASSES - CATHEDRAL			20 €/pc.



CODE	VERRE / GLASS	DESCRIPTION	PRIX / PRICE
P6200		BLIND	246 €
P6201	1	PETIT BOIS / TRANSOM	371 €
P6201	1	DECO	487 €
Aluminium Couvre/Covering (mdf 4 / 6mm) 90x210cm			130 €
Aluminium Couvre/Covering (mdf 4 / 6mm)100x225cm			155 €
SURCHARGE DE VERRE triplex - cathedral CHARGES FOR TRIPLEX GLASSES - CATHEDRAL			20 €/pc.



CODE	VERRE / GLASS	DESCRIPTION	PRIX / PRICE
P6240		BLIND	246 €
P6242	2	PETIT BOIS / TRANSOM	358 €
P6242	2	GRILLE / SAFETY	500 €
Aluminium Couvre/Covering (mdf 4 / 6mm) 90x210cm			130 €
Aluminium Couvre/Covering (mdf 4 / 6mm)100x225cm			155 €
SURCHARGE DE VERRE triplex - cathedral CHARGES FOR TRIPLEX GLASSES - CATHEDRAL			15 €/pc.



CODE	VERRE / GLASS	DESCRIPTION	PRIX / PRICE
P6210		BLIND	246 €
P6212	2	PETIT BOIS / TRANSOM	358 €
P6212	2	GRILLE / SAFETY	500 €
P6212	2	KARAVOLO	500 €
Aluminium Couvre/Covering (mdf 4 / 6mm) 90x210cm			130 €
Aluminium Couvre/Covering (mdf 4 / 6mm)100x225cm			155 €
SURCHARGE DE VERRE triplex - cathedral CHARGES FOR TRIPLEX GLASSES - CATHEDRAL			15 €/pc.



CODE	VERRE / GLASS	DESCRIPTION	PRIX / PRICE
P6250		BLIND	246 €
P6253	3	PETIT BOIS / TRANSOM	325 €
P6253	3	GRILLE / SAFETY	473 €
P6255	5	PETIT BOIS / TRANSOM	365 €
Aluminium Couvre/Covering (mdf 4 / 6mm) 90x210cm			130 €
Aluminium Couvre/Covering (mdf 4 / 6mm)100x225cm			155 €
SURCHARGE DE VERRE triplex - cathedral CHARGES FOR TRIPLEX GLASSES - CATHEDRAL			10 €/pc.

P6000 Series Heavy Duty

Panneau Aluminium Presses
à usage intensif 1.2 mm
Heavy duty aluminium
pressed panel 1.2 mm

	CODE	VERRE / GLASS	DESCRIPTION	PRIX / PRICE
	P6600		BLIND	159 €
	P6601	1	PETIT BOIS / TRANSOM	275 €
	P6601	1	GRILLE / SAFETY	294 €
	SURCHARGE DE VERRE TRIPLEX - CATHEDRAL CHARGES FOR TRIPLEX GLASSES - CATHEDRAL			5 €/pc
	P6630		BLIND	159 €
	P6631	1	PETIT BOIS / TRANSOM	254 €
	P6632	2	PETIT BOIS / TRANSOM	267 €
	SURCHARGE DE VERRE TRIPLEX - CATHEDRAL CHARGES FOR TRIPLEX GLASSES - CATHEDRAL			10 €/pc

	CODE	VERRE / GLASS	DESCRIPTION	PRIX / PRICE
	P6700		BLIND	159 €
	P6701	1	PETIT BOIS / TRANSOM	281 €
	SURCHARGE DE VERRE TRIPLEX - CATHEDRAL CHARGES FOR TRIPLEX GLASSES - CATHEDRAL			15 €/pc
	P6710		BLIND	159 €
	P6711	1	PETIT BOIS / TRANSOM	281 €
	P6711	1	GRILLE / SAFETY	294 €
	P6711	1	KARAVOLO	294 €
	SURCHARGE DE VERRE TRIPLEX - CATHEDRAL CHARGES FOR TRIPLEX GLASSES - CATHEDRAL			15 €/pc

	CODE	VERRE / GLASS	DESCRIPTION	PRIX / PRICE
	P6680		BLIND	159 €
	P6681	1	PETIT BOIS / TRANSOM	281 €
	SURCHARGE DE VERRE TRIPLEX - CATHEDRAL CHARGES FOR TRIPLEX GLASSES - CATHEDRAL			10 €/pc
	P6690		BLIND	159 €
	P6693	3	PETIT BOIS / TRANSOM	294 €
	P6693	3	GRILLE / SAFETY	322 €
	P6695	5	GRILLE / SAFETY	376 €
	SURCHARGE DE VERRE TRIPLEX - CATHEDRAL CHARGES FOR TRIPLEX GLASSES - CATHEDRAL			5 €/pc

	CODE	VERRE / GLASS	DESCRIPTION	PRIX / PRICE
	P6740		BLIND	159 €
	P6741	1	PETIT BOIS / TRANSOM	281 €
	P6741	1	GRILLE / SAFETY	347 €
	SURCHARGE DE VERRE TRIPLEX - CATHEDRAL CHARGES FOR TRIPLEX GLASSES - CATHEDRAL			10 €/pc
	P6750		BLIND	159 €
	P6751	1	PETIT BOIS / TRANSOM	254 €
	P6752	2	PETIT BOIS / TRANSOM	281 €
	P6752	2	GRILLE / SAFETY	294 €
	P6753	3	PETIT BOIS / TRANSOM	308 €
	SURCHARGE DE VERRE TRIPLEX - CATHEDRAL CHARGES FOR TRIPLEX GLASSES - CATHEDRAL			10 €/pc

Panneau Blind / Blind Panels

DESCRIPTION	BLIND PLAT / FLAT BLIND			
	DIMENSIONS	1.0mm	1.2mm	2.0mm
	45x210 cm	85 €	127 €	-
90x210 cm	140 €	199 €	268 €	
100x200 cm	-	-	-	
125x250 cm	227 €	-	482 €	
100x225 cm	172 €	241 €	-	

DESCRIPTION	FP20 Alublack BLIND PLAT / FLAT BLIND	
	DIMENSIONS	CODE
90x210 cm	FP090-210/5	78 €
120x250 cm	FP120-250/5	136 €

Couvre d'Aluminium / Aluminium Covering (mdf 4/6mm) 90x210cmx1mm	75 €/m
Couvre d'Aluminium / Aluminium Covering (mdf 4/6mm) 100x225cm x1mm	100 €/m

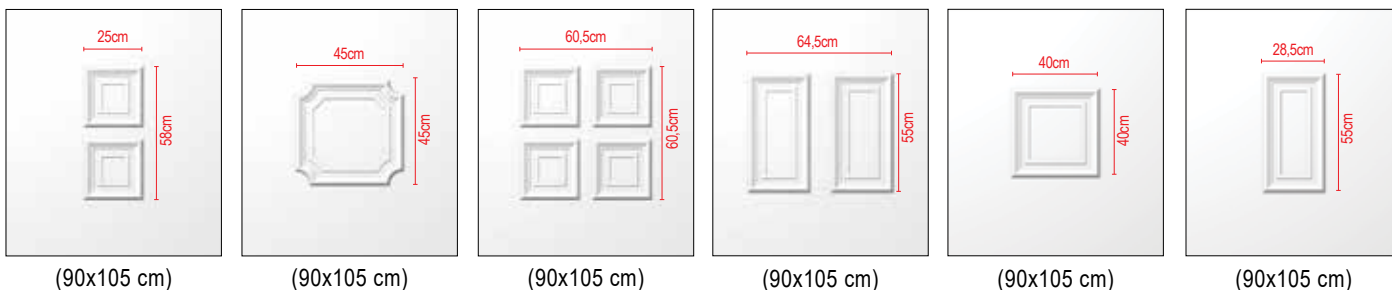

CODE	E525	CODE	E538	CODE	E543	CODE	E595	CODE	E596	CODE	E597
PRICE PRIX	107 €	PRICE PRIX	107 €	PRICE PRIX	107 €	PRICE PRIX	107 €	PRICE PRIX	107 €	PRICE PRIX	107 €

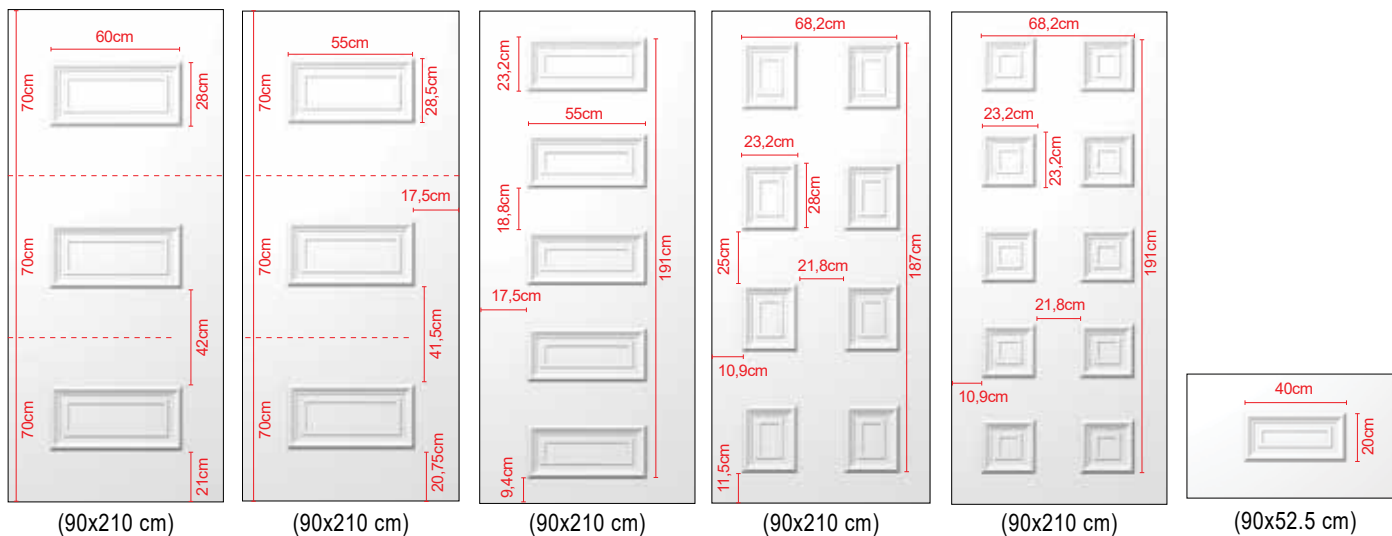

CODE	E542	CODE	E794	CODE	E594	CODE	E598	CODE	E599	CODE	E544
PRICE PRIX	177 €	PRICE PRIX	177 €	PRICE PRIX	177 €	PRICE PRIX	177 €	PRICE PRIX	177 €	PRICE PRIX	55 €

Poignées / Handles

HANDLE MAT
NICKEL / CHROME
POIGNÉE NICKEL /
CHROME



LENGTH LONGEUR mm	CODE	PRICE PRIX
400	0871X2-040	93,20 €
500	0871X2-050	98,50 €
600	0871X2-060	102,50 €
800	0871X2-080	111,80 €
1000	0871X2-100	121,10 €
1200	0871X2-120	129,10 €
1500	0871X2-150	138,40 €
1600	0871X2-160	132,00 €
1800	0871X2-180	157,10 €
2000	0871X2-200	165,00 €

HANDLE MAT NICKEL
POIGNÉE NICKEL MAT



LENGTH LONGEUR mm	CODE	PRICE PRIX
400	0873X1-040	111,80 €
500	0873X1-050	122,40 €
600	0873X1-060	133,10 €
800	0873X1-080	153,10 €
1000	0873X1-100	174,40 €
1200	0873X1-120	143,00 €
1500	0873X1-150	238,30 €
1600	0873X1-160	179,00 €
1800	0873X1-180	194,00 €
2000	0873X1-200	210,00 €

HANDLE NICKEL / INOX
POIGNÉE NICKEL / INOX



LENGTH LONGEUR mm	CODE	PRICE PRIX
400	0879X3-040	177,00 €
500	0879X3-050	193,10 €
600	0879X3-060	209,00 €
800	0879X3-080	239,60 €
1000	0879X3-100	270,20 €
1200	0879X3-120	302,20 €
1500	0879X3-150	348,70 €
1600	0879X3-160	363,30 €
1800	0879X3-180	395,30 €
2000	0879X3-200	425,90 €

HANDLE NICKEL/INOX
POIGNÉE NICKEL / INOX



LENGTH LONGEUR mm	CODE	PRICE PRIX
400	0669X3-040	133,10 €
500	0669X3-050	154,40 €
600	0669X3-060	175,70 €
800	0669X3-080	215,60 €
1000	0669X3-100	252,90 €
1200	0669X3-120	292,80 €
1500	0669X3-150	346,10 €
1600	0669X3-160	367,40 €
1800	0669X3-180	407,30 €
2000	0669X3-200	445,90 €

HANDLE NICKEL/INOX
POIGNÉE NICKEL / INOX



LENGTH LONGEUR mm	CODE	PRICE PRIX
400	0670X3-040	56,00 €
500	0670X3-050	62,00 €
600	0670X3-060	68,00 €
800	0670X3-080	78,00 €
1000	0670X3-100	86,00 €
1200	0670X3-120	96,00 €

HANDLE NICKEL / INOX
POIGNÉE NICKEL / INOX



LENGTH LONGEUR mm	CODE	PRICE PRIX
455	0461X3-040	93,20 €
657	0461X3-060	109,10 €
858	0461X3-080	119,80 €
1059	0461X3-100	133,10 €

HANDLE NICKEL / INOX
POIGNÉE NICKEL / INOX

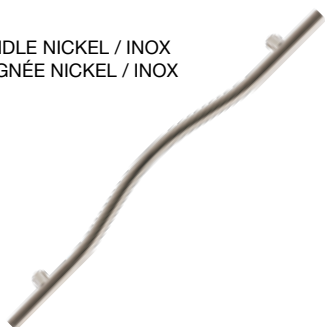

LENGTH LONGEUR mm	CODE	PRICE PRIX
890	0617X3-089	130,00 €

HANDLE MAT NICKEL
POIGNÉE NICKEL MAT



LENGTH LONGEUR mm	CODE	PRICE PRIX
300	0883X1-025	55,70 €
555	0883X1-050	95,30 €

HANDLE Ø40 ANODISED
ALUMINIUM
POIGNÉE Ø40 ALUMINIUM
ANODISÉ



LENGTH LONGEUR mm	CODE	PRICE PRIX
600	165-500	52,40 €

Poignées / Handles

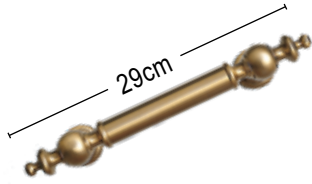

LONGEUR / LENGTH	CODE	PRIX / PRICE
29cm	520	50,20 €

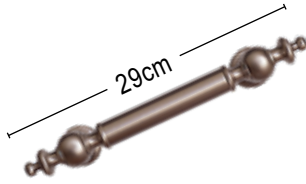

LONGEUR / LENGTH	CODE	PRIX / PRICE
29cm	520S	50,20 €

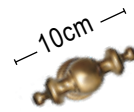

LONGEUR / LENGTH	CODE	PRIX / PRICE
10cm	521	28,00 €

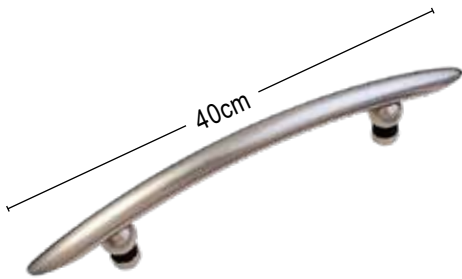

LONGEUR / LENGTH	CODE	PRIX / PRICE
40cm	102	40,00 €



CODE	PRIX / PRICE
165-400	59,00 €



	CODE	PRIX / PRICE
Ø50mm	0449P3-005	48,00 €
Ø60mm	0449P3-006	42,00 €
Ø70mm	0449P3-007	69,20 €
Ø80mm	0449P3-008	77,20 €



	CODE	PRIX / PRICE
Ø60mm	0697P4-006	33,30 €
Ø80mm	0697P4-008	55,40 €



	CODE	PRIX / PRICE
60x60mm	0785P4-006	48,00 €
80x80mm	0785P4-008	79,90 €

Grilles-Vitrage / Safeties-Glasses

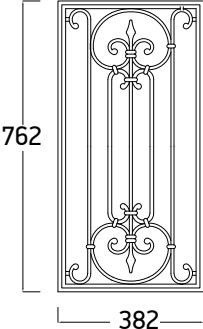
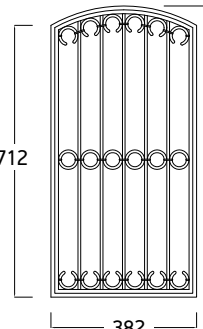
Design	Code		Prix / Price	Design	Code		Prix / Price
	XA100A	Grilles / Safeties	27,60 €		XA110A	Grilles / Safeties	49,50 €
	T0170	Verre / Glass	109,50 €		T0171	Verre / Glass	109,50 €

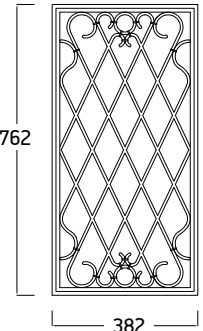
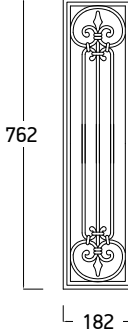
Design	Code		Prix / Price	Design	Code		Prix / Price
	XA120A	Grilles / Safeties	28,00 €		XA105A	Grilles / Safeties	17,80 €
	T0172	Verre / Glass	109,50 €		T0173	Verre / Glass	78,50 €

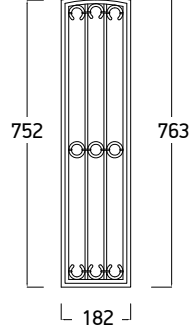
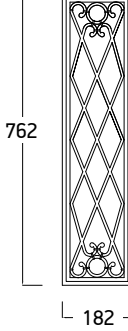
Design	Code		Prix / Price	Design	Code		Prix / Price
	XA115A	Grilles / Safeties	9,50 €		XA125A	Grilles / Safeties	20,20 €
	T0174	Verre / Glass	78,50 €		T0175	Verre / Glass	78,50 €

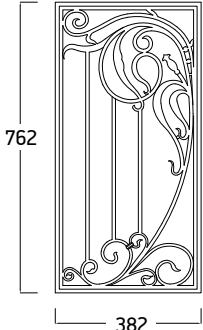
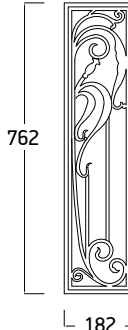
Design	Code		Prix / Price	Design	Code		Prix / Price
	XA160A	Grilles / Safeties	30,30 €		XA165A	Grilles / Safeties	19,50 €
	T0180	Verre / Glass	109,50 €		T0185	Verre / Glass	78,50 €

Tous les vitrages si-dessus sont disponibles en blanc (RAL 9016) et noir (RAL 9005)
 All the above safeties are available in White (RAL 9016) & Black (RAL 9005)

Grilles-Vitrage / Safeties-Glasses

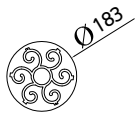
Design	Code		Prix / Price
	AE202A	Grilles / Safeties	54,00 €
	T0202-S1	Verre / Glass	107,00 €

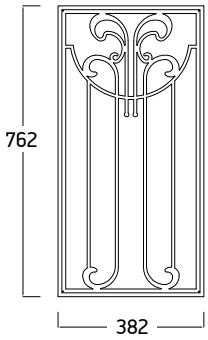
Design	Code		Prix / Price
	AE182A	Grilles / Safeties	119,30 €
	T0182	Verre / Glass	126,00 €

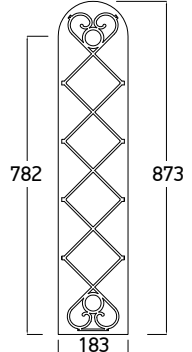
Design	Code		Prix / Price
	AE204K	Grilles / Safeties	61,50 €
	T0204-S1	Verre / Glass	127,50 €

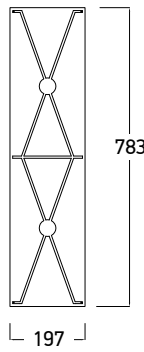
Design	Code		Prix / Price
	AE508A	Grilles / Safeties	60,80 €
	T0508-S1	Grilles / Safeties	122,00 €

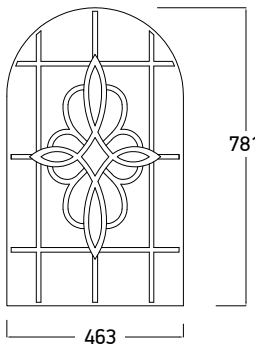
Design	Code		Prix / Price
	XA910A	Grilles / Safeties	17,70 €
	T0514-S1	Verre / Glass	67,50 €

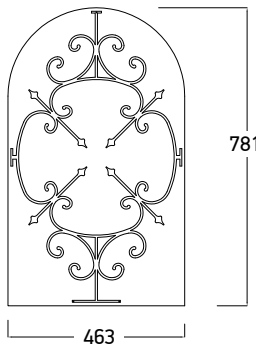
Design	Code		Prix / Price
	AE514A	Grilles / Safeties	109,50 €
	T0514-S2	Verre / Glass	223,50 €

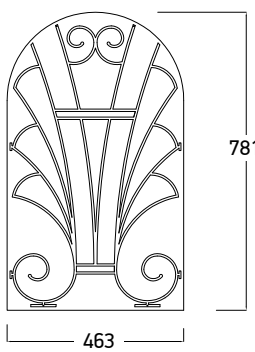
Design	Code		Prix / Price
	XA518A	Grilles / Safeties	19,60 €
	T0514-S3	Verre / Glass	64,50 €

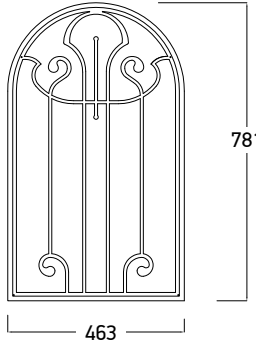
Design	Code		Prix / Price
	AE514Z	Grilles / Safeties	127,50 €
	T0514-S4	Verre / Glass	259,00 €

Tous les vitrages si-dessus sont disponibles en blanc (RAL 9016) et noir (RAL 9005)
 All the above safeties are available in White (RAL 9016) & Black (RAL 9005)

Grilles-Vitrage / Safeties-Glasses

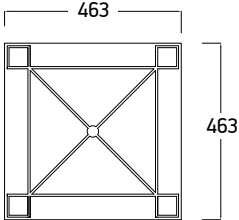
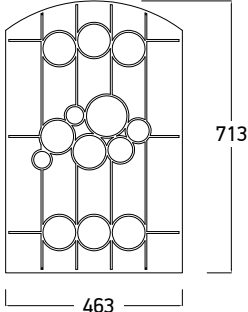
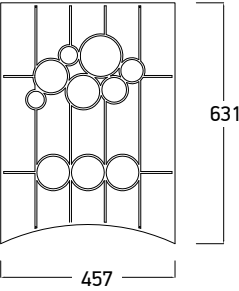
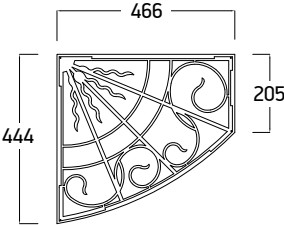
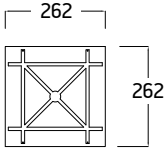
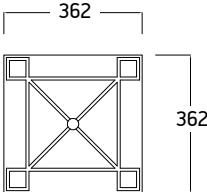
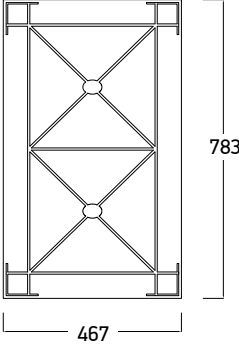
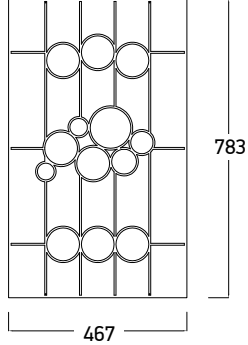
Design	Code		Prix / Price	Design	Code		Prix / Price
	AE531A	Grilles / Safeties	57,80 €		AE533Z	Grilles / Safeties	121,50 €
	T0531-S1	Verre / Glass	117,50 €		T0533-S4	Verre / Glass	247,50 €
	AE535A	Grilles / Safeties	88,50 €		AE565A	Grilles / Safeties	102,00 €
	T0535-S1	Verre / Glass	177,50 €		T0565-S1	Verre / Glass	206,00 €
	AE723A	Grilles / Safeties	54,00 €		XA729A	Grilles / Safeties	8,50 €
	T0721-S1	Verre / Glass	106,00 €		T0729-S1	Verre / Glass	57,00 €
	XA741A	Grilles / Safeties	13,90 €		AE741Z	Grilles / Safeties	121,50 €
	T0741-S1	Verre / Glass	96,50 €		T0741-S4	Verre / Glass	250,50 €

Tous les vitrages si-dessus sont disponibles en blanc (RAL 9016) et noir (RAL 9005)
 All the above safeties are available in White (RAL 9016) & Black (RAL 9005)

Grilles-Vitrage / Safeties-Glasses

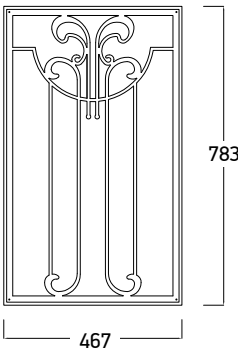
Design	Code		Prix / Price
	AE741H	Grilles / Safeties	131,30 €
	T0741-S5	Verre / Glass	267,50 €

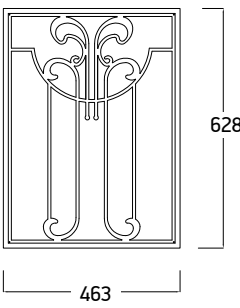
Design	Code		Prix / Price
	AE761H	Grilles / Safeties	131,30 €
	T0761-S5	Verre / Glass	267,50 €

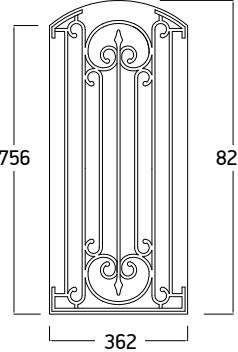
Design	Code		Prix / Price
	XA771A	Grilles / Safeties	25,90 €
	T0771-S1	Verre / Glass	96,50 €

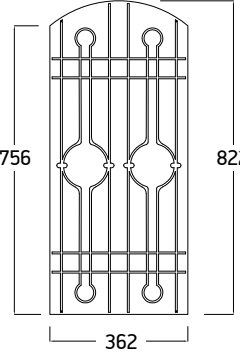
Design	Code		Prix / Price
	AE771E	Grilles / Safeties	121,50 €
	T0771-S3	Verre / Glass	250,50 €

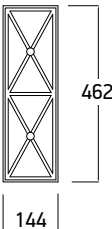
Design	Code		Prix / Price
	XA811A	Grilles / Safeties	20,50 €
	T0811-S1	Verre / Glass	43,00 €

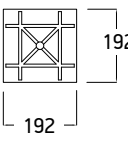
Design	Code		Prix / Price
	XA821A	Grilles / Safeties	3,70 €
	T0822-S1	Verre / Glass	29,00 €

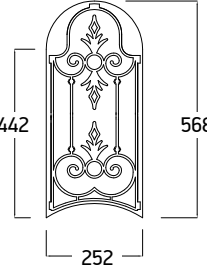
Design	Code		Prix / Price
	XA874A	Grilles / Safeties	30,00 €
	T0874-S2	Verre / Glass	65,50 €

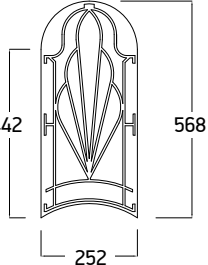
Design	Code		Prix / Price
	AE874B	Grilles / Safeties	79,50 €
	T0874-S3	Verre / Glass	160,50 €

Tous les vitrages si-dessus sont disponibles en blanc (RAL 9016) et noir (RAL 9005)
 All the above safeties are available in White (RAL 9016) & Black (RAL 9005)

Grilles-Vitrage / Safeties-Glasses

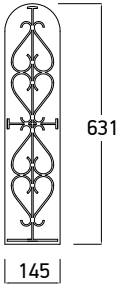
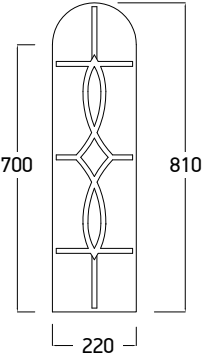
Design	Code		Prix / Price	Design	Code		Prix / Price
	XA881A	Grilles / Safeties	22,50 €		XA943A	Grilles / Safeties	5,80 €
	T0881-S1	Verre / Glass	48,50 €		T0900-S1	Verre / Glass	32,50 €

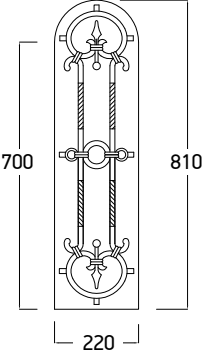
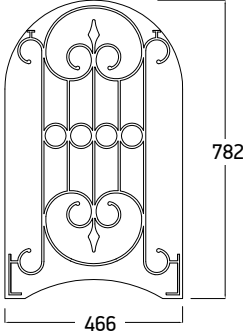
Design	Code		Prix / Price	Design	Code		Prix / Price
	XA900A	Grilles / Safeties	7,30 €		XA928B	Grilles / Safeties	18,70 €
	T0900-KB	Verre / Glass	78,50 €		T0928-S2	Verre / Glass	76,00 €

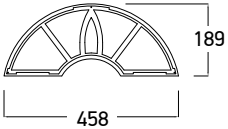
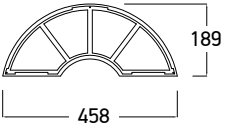
Design	Code		Prix / Price	Design	Code		Prix / Price
	XA981E	Grilles / Safeties	4,30 €		XA981B	Grilles / Safeties	4,30 €
	T0981-S1	Verre / Glass	34,50 €		T0981-KB	Verre / Glass	28,00 €

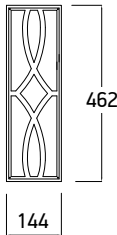
Design	Code		Prix / Price
	XA983E	Grilles / Safeties	5,50 €
	T0983-S1	Verre / Glass	35,50 €

Tous les vitrages si-dessus sont disponibles en blanc (RAL 9016) et noir (RAL 9005)
 All the above safeties are available in White (RAL 9016) & Black (RAL 9005)

Grilles-Vitrage / Safeties-Glasses

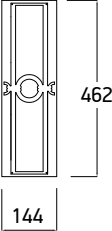
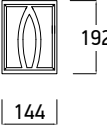
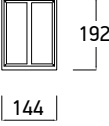
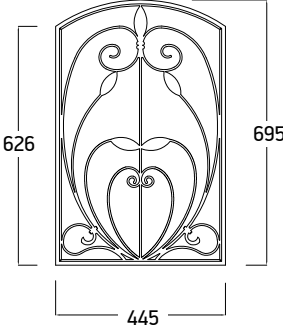
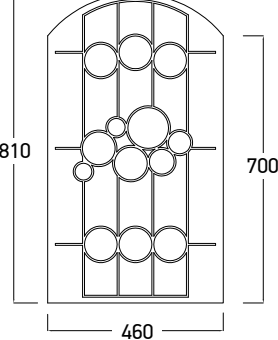
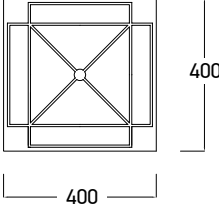
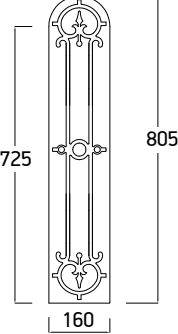
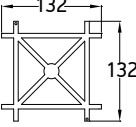
Design	Code		Prix / Price	Design	Code		Prix / Price
	XA983B	Grilles / Safeties	5,50 €		XA987E	Grilles / Safeties	10,00 €
	T0983-KB	Verre / Glass	34,50 €		T0987-S1	Verre / Glass	20,50 €
	XA987B	Grilles / Safeties	10,00 €		AE6121A	Grilles / Safeties	131,30 €
	T0987-KB	Verre / Glass	20,50 €		T06121-S2	Verre / Glass	267,50 €
	AE6171Z	Grilles / Safeties	131,30 €		XA6151A	Grilles / Safeties	62,00 €
	T06171-S4	Verre / Glass	267,50 €		T06151-S1	Verre / Glass	137,00 €
	XA6212A	Grilles / Safeties	30,00 €		AE568A	Grilles / Safeties	45,80 €
	T06212-KB	Verre / Glass	65,50 €		T0568-S5	Verre / Glass	90,50 €

Tous les vitrages si-dessus sont disponibles en blanc (RAL 9016) et noir (RAL 9005)
 All the above safeties are available in White (RAL 9016) & Black (RAL 9005)

Grilles-Vitrage / Safeties-Glasses

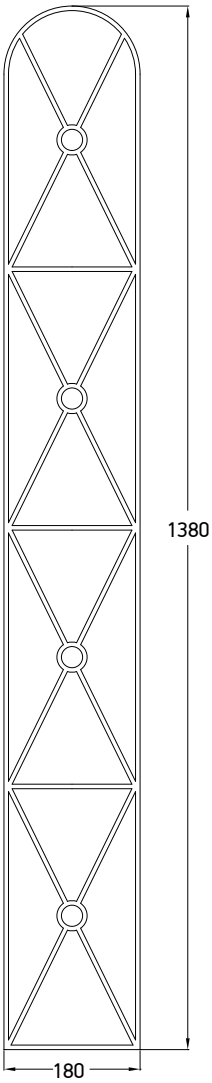
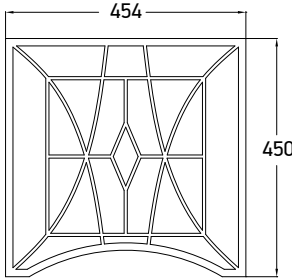
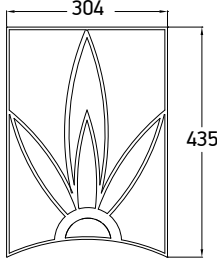
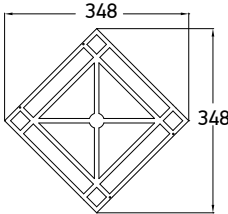
Design	Code	Prix / Price	Design	Code	Prix / Price
	AE553A	112,50 €		AE711B	73,50 €
	T0553-S1	229,00 €		T0711-S1	148,00 €
				AE846A	142,50 €
				T0846-S1	294,50 €

Tous les vitrages si-dessus sont disponibles en blanc (RAL 9016) et noir (RAL 9005)
 All the above safeties are available in White (RAL 9016) & Black (RAL 9005)

Grilles-Vitrage / Safeties-Glasses

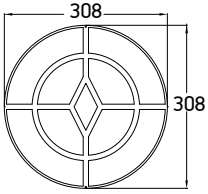
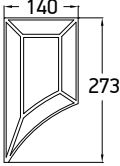
Design	Code		Prix / Price	Design	Code		Prix / Price
	AE848A		61,50 €		AE862A		54,00 €
	T0848-S1		124,50 €		T0862-S1		107,00 €
		Grilles / Safeties				Grilles / Safeties	
		Verre / Glass				Verre / Glass	

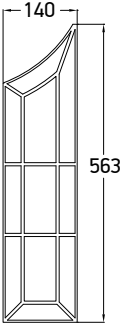
Design	Code		Prix / Price
	AE864A		88,50 €
	T0864-S1		177,50 €
		Grilles / Safeties	
		Verre / Glass	

Tous les vitrages si-dessus sont disponibles en blanc (RAL 9016) et noir (RAL 9005)
 All the above safeties are available in White (RAL 9016) & Black (RAL 9005)

Forme / Shape	Description	Code	Prix / Price
	ALUMINIUM FONDU PARTIE SUPERIEUR UPPER CAST PART	XY100A	31,00 €/pc
	ALUMINIUM FONDU PARTIE MOYENNE MIDDLE CAST PART	XY100M	31,00 €/pc
	ALUMINIUM FONDU PARTIE INFERIEURE BOTTOM CAST PART	XY100K	31,00 €/pc
	ALUMINIUM FONDU PARTIE SUPERIEUR UPPER CAST PART	XY130A	26,60 €/pc
	ALUMINIUM FONDU PARTIE MOYENNE MIDDLE CAST PART	XY130M	26,60 €/pc
	ALUMINIUM FONDU PARTIE INFERIEURE BOTTOM CAST PART	XY130K	26,60 €/pc
	ALUMINIUM FONDU PARTIE SUPERIEUR UPPER CAST PART	X1070A	34,00 €/pc
	ALUMINIUM FONDU PARTIE SUPERIEUR UPPER CAST PART	X1075A	31,00 €/pc

Les prix sont pour couleur blanc (RAL 9016). Les prix sont net et ne prennent pas d'escompte.
All the above casts are available in White (RAL 9016). Prices are NET.

Σχήμα / Shape	Περιγραφή / Description	Code	Prix / Price
	ALUMINIUM FONDU PARTIE SUPERIEUR UPPER CAST PART	X138A	31,00 €/pc
	ALUMINIUM FONDU PARTIE MOYENNE MIDDLE CAST PART	X148M	31,00 €/pc
	ALUMINIUM FONDU PARTIE SUPERIEUR UPPER CAST PART	X168A	34,00 €/pc
	ALUMINIUM FONDU PARTIE SUPERIEUR UPPER CAST PART	X128A	32,50 €/pc
	ALUMINIUM FONDU PARTIE MOYENNE MIDDLE CAST PART	X128M	26,60 €/pc
	ALUMINIUM FONDU PARTIE SUPERIEUR UPPER CAST PART	X148A	34,00 €/pc

Les prix sont pour couleur blanc (RAL 9016). Les prix sont net et ne prennent pas d' escompte.
All the above casts are available in White (RAL 9016) . Prices are NET.

LISTE DE PRIX FEUILLES D' ALUMINIUM / ALUMINIUM SHEET PRICELIST

DESCRIPTION	DIMENSIONS	PRIX / PRICE
FEUILLE ALUMINIUM PRESSEE BRUT PRESSED ALUMINIUM SHEET IN MILL FINISH	45 x 210 x 1.0	37,00 €
	45 x 210 x 1.2	40,90 €
	90 x 210 x 1.0	70,50 €
	90 x 210 x 1.2	75,60 €
FEUILLE ALUMINIUM PRESSEE COULEUR BLANC PRESSED ALUMINIUM SHEET IN WHITE COLOUR	45 x 210 x 1.0	43,00 €
	45 x 210 x 1.2	44,70 €
	90 x 210 x 1.0	83,50 €
	90 x 210 x 1.2	89,80 €
FEUILLE ALUMINIUM PERFOREE BRUT ALUMINIUM SHEET, PRE-CUT IN MILL FINISH	45 x 210 x 1.0	42,80 €
	45 x 210 x 1.2	50,00 €
	90 x 210 x 1.0	74,60 €
	90 x 210 x 1.2	83,60 €
FEUILLE ALUMINIUM PERFOREE COULEUR BLANC ALUMINIUM SHEET, PRE-CUT IN WHITE COLOUR	45 x 210 x 1.0	47,00 €
	45 x 210 x 1.2	53,20 €
	90 x 210 x 1.0	85,50 €
	90 x 210 x 1.2	97,90 €

SURCHARGE COULEURS / COLOR SURCHARGES	DIMENSIONS	PRIX / PRICE
FEUILLE ALUMINIUM COULEUR RAL ALUMINIUM SKIN IN RAL COLOURS	45 x 210	15,00 €
	90 x 210	25,00 €
FEUILLE ALUMINIUM COULEUR SPECIALE ALUMINIUM IN SPECIAL COLOURS	45 x 210	20,00 €
	90 x 210	35,00 €
FEUILLE ALUMINIUM FINISSAGE BOIS ALUMINIUM IN WOOD FINISH	45 x 210	25,00 €
	90 x 210	45,00 €

