

# ALUMINCO®

ALUMINIUM BUILDING SYSTEMS



Crystaline®  
railing system

Τιμοκατάλογος / Pricelist

## Βάσεις στήριξης υαλοπινάκα / Glass supporting bases



ΒΑΣΗ ΥΑΛΟΠΙΝΑΚΑ  
GLASS BASE

ΚΩΔ. / CODE	<b>F85-150A</b>
ΤΙΜΗ / PRICE	<b>27,20 €/pc</b>



ΒΑΣΗ ΥΑΛΟΠΙΝΑΚΑ  
GLASS BASE

ΚΩΔ. / CODE	<b>F85-300A</b>
ΤΙΜΗ / PRICE	<b>37,50 €/pc</b>

## Προφίλ & εξαρτήματα / Profiles & accessories

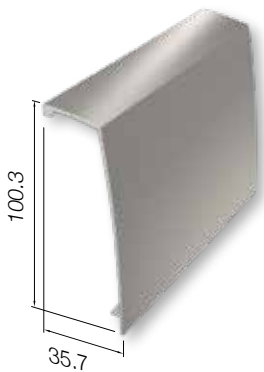

ΚΑΠΑΚΙ ΒΑΣΗΣ / BASE COVER

ΚΩΔ. / CODE	<b>F85-1K1</b>
ΒΑΡΟΣ / WEIGHT	550gr/m
ΜΗΚΟΣ / LENGTH	6 m
ΤΙΜΗ / PRICE	<b>7,70 €/Kg</b>



ΤΑΠΑ / END CAP

ΚΩΔ. / CODE	<b>F85-416</b>
ΦΥΣΙΚΗ ΑΝΟΔΙΩΣΗ ANODIZE NATURAL	<b>7,20 €/pc</b>
ΓΥΑΛΙΣΤΕΡΗ ΑΝΟΔΙΩΣΗ F50 ANODIZE GLOSS F50	<b>7,35 €/pc</b>
ΛΕΥΚΟ / ΜΑΥΡΟ WHITE / BLACK	<b>7,30 €/pc</b>



ΤΑΠΑ (ΣΚΙΣΤΗ)  
END CAP (PERFORATED)

ΚΩΔ. / CODE	<b>F85-416L (8.8.4)</b>
ΦΥΣΙΚΗ ΑΝΟΔΙΩΣΗ ANODIZE NATURAL	<b>8,20 €/pc</b>
ΓΥΑΛΙΣΤΕΡΗ ΑΝΟΔΙΩΣΗ F50 ANODIZE GLOSS F50	<b>8,30 €/pc</b>
ΛΕΥΚΟ / ΜΑΥΡΟ	<b>8,20 €/pc</b>

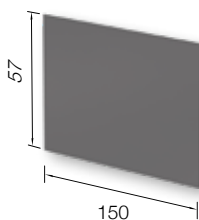

ΦΥΛΛΟ PVC 1.5 MM  
PVC SHEET 1.5 MM

ΚΩΔ. / CODE	<b>F85-E009</b>
ΧΡΩΜΑ / COLOR	Μαύρο/Black
ΜΗΚΟΣ / LENGTH	150 mm
ΤΙΜΗ / PRICE	<b>1,30 €/pc</b>

ΠΕΡΙΛΑΜΒΑΝΕΤΑΙ ΣΤΗ ΒΑΣΗ ΣΤΗΡΙΞΗΣ F85-150A ΑΛΛΑ ΔΙΑΤΙΘΕΤΑΙ ΚΑΙ ΜΕΜΟΝΩΜΕΝΑ  
INCLUDED IN THE GLASS SUPPORT BASE F85-150A, ALSO AVAILABLE SEPERATELY

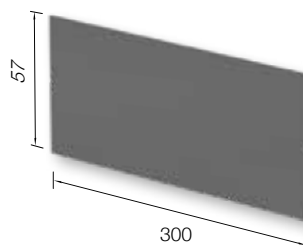

ΦΥΛΛΟ PVC 1.5 MM  
PVC SHEET 1.5 MM

ΚΩΔ. / CODE	<b>F85-E010</b>
ΧΡΩΜΑ / COLOR	Μαύρο/Black
ΜΗΚΟΣ / LENGTH	300 mm
ΤΙΜΗ / PRICE	<b>2,45 €/pc</b>

ΠΕΡΙΛΑΜΒΑΝΕΤΑΙ ΣΤΗ ΒΑΣΗ ΣΤΗΡΙΞΗΣ F85-300A ΑΛΛΑ ΔΙΑΤΙΘΕΤΑΙ ΚΑΙ ΜΕΜΟΝΩΜΕΝΑ  
INCLUDED IN THE GLASS SUPPORT BASE F85-300A, ALSO AVAILABLE SEPERATELY

# A10•line

## Βάση στήριξης υαλοπίνακα / Glass supporting base

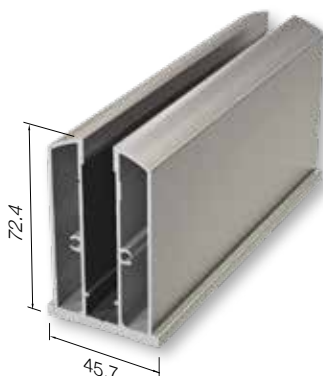

### ΠΡΟΦΙΛ ΒΑΣΗΣ / BASE PROFILE

ΚΩΔ. / CODE	<b>F85-904</b>
ΒΑΡΟΣ / WEIGHT	1796gr/m
ΜΗΚΟΣ / LENGTH	6 m
ΤΙΜΗ / PRICE	<b>7,70 €/Kg</b>

## Προφίλ & εξαρτήματα / Profiles & accessories



### ΣΤΡΟΓΓΥΛΗ ΚΟΥΠΑΣΤΗ Ø50 ROUND HANDRAIL Ø50

ΚΩΔ. / CODE	<b>F85-202</b>
ΒΑΡΟΣ / WEIGHT	721 gr/m
ΜΗΚΟΣ / LENGTH	6 m
ΤΙΜΗ / PRICE	<b>7,70 €/Kg</b>



### ΤΑΠΑ / END CAP

ΚΩΔ. / CODE	<b>F85-444</b>
ΦΥΣΙΚΗ ΑΝΟΔΙΩΣΗ ANODIZE NATURAL	<b>5,50 €/pc</b>
ΓΥΑΛΙΣΤΕΡΗ ΑΝΟΔΙΩΣΗ F50 ANODIZE GLOSS F50	<b>5,55 €/pc</b>



### ΤΑΠΑ ΚΑΛΥΨΗΣ ΟΠΩΝ HOLE COVERING CAP

ΚΩΔ. / CODE	<b>4438</b>
ΦΥΣΙΚΗ ΑΝΟΔΙΩΣΗ ANODIZE NATURAL	<b>0,50 €/pc</b>
ΓΥΑΛΙΣΤΕΡΗ ΑΝΟΔΙΩΣΗ F50 ANODIZE GLOSS F50	<b>0,55 €/pc</b>

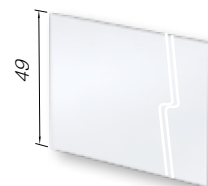

### ΦΥΛΛΟ PVC 1 MM PVC SHEET 1 MM

ΚΩΔ. / CODE	<b>F85-411</b>
ΥΛ. / MATERIALE	PVC
ΧΡΩΜΑ / COLOR	White
ΜΗΚΟΣ / LENGTH	2 m
ΤΙΜΗ / PRICE	<b>2,50 €/pc</b>

## Λάστιχα / Gaskets



### ΛΑΣΤΙΧΟ ΒΑΣΗΣ / BASE GASKET

ΚΩΔ. / CODE	<b>EA420-443M</b>
ΥΛ. / MATERIALE	EPDM
ΜΗΚΟΣ / LENGTH	150 m
ΤΙΜΗ / PRICE	<b>0,37 €/m</b>



### ΛΑΣΤΙΧΟ ΣΦΗΝΑ ΤΖΑΜΙΟΥ 1MM GLAZING GASKET 1MM

ΚΩΔ. / CODE	<b>EA410-420M</b>
ΥΛ. / MATERIALE	EPDM
ΜΗΚΟΣ / LENGTH	350 m
ΤΙΜΗ / PRICE	<b>0,37 €/m</b>

# C2·line

## Βάσεις στήριξης υαλοπίνακα / Glass supporting bases



ΒΑΣΗ ΥΑΛΟΠΙΝΑΚΑ  
GLASS BASE

ΚΩΔ. / CODE	<b>F85-150C2/16</b> (8.8.4)
	<b>F85-150C2/20</b> (10.10.4)
ΤΙΜΗ / PRICE	<b>28,30 €/pc</b>

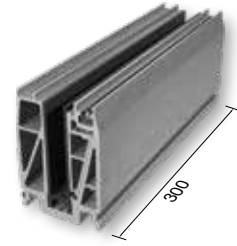

ΒΑΣΗ ΥΑΛΟΠΙΝΑΚΑ  
GLASS BASE

ΚΩΔ. / CODE	<b>F85-300C2/16</b> (8.8.4)
	<b>F85-300C2/20</b> (10.10.4)
ΤΙΜΗ / PRICE	<b>37,10 €/pc</b>

## Προφίλ και εξαρτήματα / Profiles and accessories



ΚΑΠΑΚΙ ΒΑΣΗΣ / BASE COVER

ΚΩΔ. / CODE	<b>F85-1K15</b>
ΒΑΡΟΣ / WEIGHT	705 gr/m
ΜΗΚΟΣ / LENGTH	6 m
ΤΙΜΗ / PRICE	<b>7,70 €/Kg</b>



ΤΑΠΑ / END CAP

ΚΩΔ. / CODE	<b>F85-415/C2</b>
ΤΙΜΗ / PRICE (1)	<b>7,90 €/pc</b>
ΤΙΜΗ / PRICE (2)	<b>8,00 €/pc</b>
ΛΕΥΚΟ / ΜΑΥΡΟ WHITE / BLACK	<b>7,95 €/pc</b>



ΤΑΠΑ (ΣΚΙΣΤΗ)  
END CAP (PERFORATED)

ΚΩΔ. / CODE	<b>F85-415/C2 L</b> (8.8.4)
	<b>F85-415/C2 M</b> (10.10.4)
ΦΥΣΙΚΗ ΑΝΟΔΙΩΣΗ ANODIZE NATURAL	<b>8,90 €/pc</b>
ΓΥΛΙΣΤΕΡΗ ΑΝΟΔΙΩΣΗ F50 ANODIZE GLOSS F50	<b>9,00 €/pc</b>
ΛΕΥΚΟ / ΜΑΥΡΟ WHITE / BLACK	<b>8,85 €/pc</b>



ΠΡΟΦΙΛ ΕΥΘΥΓΡΑΜΜΙΣΗΣ ΒΑΣΕΩΝ  
ALIGNMENT PROFILE

ΚΩΔ. / CODE	<b>PAT39-120</b>
ΒΑΡΟΣ / WEIGHT	121 gr/m
ΜΗΚΟΣ / LENGTH	6 m

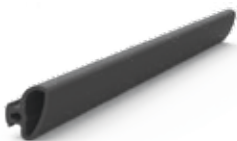

ΛΑΣΤΙΧΟ ΥΑΛΟΠΙΝΑΚΑ ΓΙΑ ΚΑΠΑΚΙ ΒΑΣΗΣ  
GASKET FOR BASE COVER

ΚΩΔ. / CODE	<b>F85-422</b> (8.8.4)	
	<b>F85-426</b> (10.10.4)	
ΥΛ. / MATERIALE	EPDM	
ΤΙΜΗ / PRICE	F85-422 <b>0,65 €/m</b>	
	F85-426 <b>0,42 €/m</b>	



ΛΑΣΤΙΧΟ "Π"  
GLASS SUPPORT SPACER

ΚΩΔ. / CODE	<b>F85-436</b>
ΥΛ. / MATERIALE	PVC
ΤΙΜΗ / PRICE	<b>3,30 €/m</b>

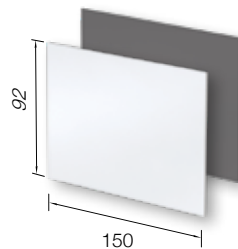

ΦΥΛΛΟ PVC / PVC SHEET

ΚΩΔ. / CODE	<b>F85-E020</b> • (1 mm)
	<b>F85-E022</b> • (3 mm)
ΧΡΩΜΑ / COLOR	Λευκό/White Μαύρο/Black
ΜΗΚΟΣ / LENGTH	150 mm
ΤΙΜΗ / PRICE	<b>0,90 €/pc</b>

ΠΕΡΙΛΑΜΒΑΝΕΤΑΙ ΣΤΗ ΒΑΣΗ ΣΤΗΡΙΞΗΣ F85-150C2 ΑΛΛΑ ΔΙΑΤΙΘΕΤΑΙ ΚΑΙ ΜΕΜΟΝΩΜΕΝΑ  
INCLUDED IN THE GLASS SUPPORT BASE F85-150C2, ALSO AVAILABLE SEPARATELY

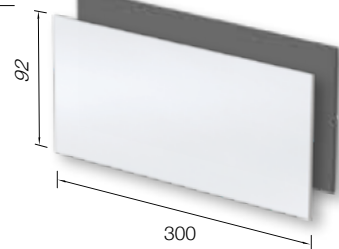

ΦΥΛΛΟ PVC / PVC SHEET

ΚΩΔ. / CODE	<b>F85-E021</b> • (1 mm)
	<b>F85-E023</b> • (3 mm)
ΧΡΩΜΑ / COLOR	Λευκό/White Μαύρο/Black
ΜΗΚΟΣ / LENGTH	300 mm
ΤΙΜΗ / PRICE	<b>2,25 €/pc</b>

ΠΕΡΙΛΑΜΒΑΝΕΤΑΙ ΣΤΗ ΒΑΣΗ ΣΤΗΡΙΞΗΣ F85-300C2 ΑΛΛΑ ΔΙΑΤΙΘΕΤΑΙ ΚΑΙ ΜΕΜΟΝΩΜΕΝΑ  
INCLUDED IN THE GLASS SUPPORT BASE F85-300C2, ALSO AVAILABLE SEPARATELY

# Ds•line

## Εξαρτήματα / Accessories

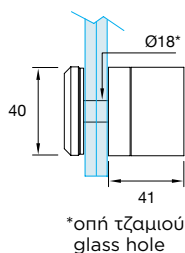

ΣΤΗΡΙΓΜΑ ΥΑΛΟΠΙΝΑΚΑ  
GLASS SUPPORT

ΚΩΔ. / CODE	<b>4149-200</b> (8.8.4)
ΥΛ. / MATERIALE	Inox 304
ΣΥΣΚ. / PACK.	12 pc (box) 4 pc (blister)
ΤΙΜΗ / PRICE	<b>35,10 €/pc</b>



ΣΤΗΡΙΓΜΑ ΥΑΛΟΠΙΝΑΚΑ  
GLASS SUPPORT

ΚΩΔ. / CODE	<b>4149-201</b> (10.10.4)
ΥΛ. / MATERIALE	Inox 316
ΣΥΣΚ. / PACK.	12 pc (box) 4 pc (blister)
ΤΙΜΗ / PRICE	<b>46,20 €/pc</b>

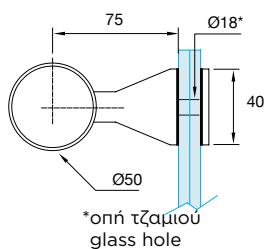

ΣΤΗΡΙΓΜΑ ΚΟΥΠΑΣΤΗΣ F50-200  
HANDRAIL SUPPORT F50-200

ΚΩΔ. / CODE	<b>4148-200</b> (8.8.4)
ΥΛ. / MATERIALE	Inox 304
ΣΥΣΚ. / PACK.	12 pc (box) 4 pc (blister)
ΤΙΜΗ / PRICE	<b>48,00 €/pc</b>



ΣΤΗΡΙΓΜΑ ΥΑΛΟΠΙΝΑΚΑ  
GLASS SUPPORT

ΚΩΔ. / CODE	<b>4148-201</b> (10.10.4)
ΥΛ. / MATERIALE	Inox 316
ΣΥΣΚ. / PACK.	12 pc (box) 4 pc (blister)
ΤΙΜΗ / PRICE	<b>48,50 €/pc</b>

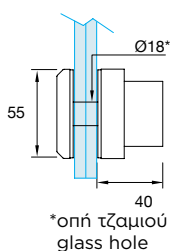

ΣΤΗΡΙΓΜΑ ΥΑΛΟΠΙΝΑΚΑ  
GLASS SUPPORT

ΚΩΔ. / CODE	<b>4136-200</b> (8.8.4) (10.10.4)
ΥΛ. / MATERIALE	Inox 316
ΣΥΣΚ. / PACK.	12 pc (box) 4 pc (blister)
ΤΙΜΗ / PRICE	<b>48,00 €/pc</b>

## TOP MOUNT $\geq 3$ KN/m



## TOP MOUNT with FIN $\geq 3$ KN/m



## TOP MOUNT $\geq 3$ KN/m



ΠΡΟΦΙΛ ΒΑΣΗΣ / BASE U-PROFILE

ΚΩΔ. / CODE	<b>F85-1B63T</b> (10.10.4) (8.8.4)
ΒΑΡΟΣ / WEIGHT	7627 gr/m
ΜΗΚΟΣ / LENGTH	3 m
ΤΙΜΗ / PRICE	<b>7,70 €/Kg</b>

Προφίλ με Κατεργασίες/Milling **9,70 €/Kg**



ΕΣΩΤΕΡΙΚΗ ΓΩΝΙΑ  
INTERNAL CORNER

ΚΩΔ. / CODE	<b>F85-551*</b>
ΜΗΚΟΣ / LENGTH	20x20 cm
ΦΥΣΙΚΗ ΑΝΟΔΙΩΣΗ ANODIZE NATURAL	<b>69,20 €/pc</b>

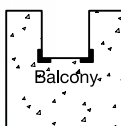

ΕΞΩΤΕΡΙΚΗ ΓΩΝΙΑ  
EXTERNAL CORNER

ΚΩΔ. / CODE	<b>F85-552*</b>
ΜΗΚΟΣ / LENGTH	20x20 cm
ΦΥΣΙΚΗ ΑΝΟΔΙΩΣΗ ANODIZE NATURAL	<b>69,20 €/pc</b>

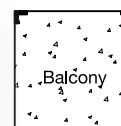

\* Περιλαμβάνουν τις βίδες αγκύρωσης/στερέωσης | Include the fixing bolts/anchors

\*\* Περιλαμβάνει την αυτοκόλλητη ταινία Lohman DuploColl 373 | Includes the adhesive tape Lohman DuploColl 373

■ ΕΞΑΡΤΗΜΑΤΑ: ΛΕΥΚΟ RAL, ΜΑΥΡΟ RAL, 420 ΑΝΟΔΙΣ ΣΤΗΝ ΤΙΜΗ ΤΗΣ ΦΥΣΙΚΗΣ ΑΝΟΔΙΩΣΗΣ. ΓΙΑ ΤΑ ΥΠΟΛΟΙΠΑ RAL Η ΕΙΔΙΚΑ ΧΡΩΜΑΤΑ, ΕΠΙΠΛΕΟΝ ΕΠΙΒΑΡΥΝΣΗ 25% & 35% ΑΝΤΙΣΤΟΙΧΑ.  
ACCESSORIES: COLORS WHITE RAL, BLACK RAL, 420 ANODIC SAME PRICE AS NATURAL ANODIZING. EXTRA CHARGE 25% AND 35% FOR ANY OTHER RAL COLORS AND SPECIAL COLORS RESPECTIVELY.



**TOP MOUNT with FIN  $\geq 3$  KN/m**

**ΠΡΟΦΙΛ ΒΑΣΗΣ / BASE U-PROFILE**

ΚΩΔ. / CODE	<b>F85-1B62</b> (10.10.4) (8.8.4)
ΒΑΡΟΣ / WEIGHT	9666 gr/m
ΜΗΚΟΣ / LENGTH	3 m
ΤΙΜΗ / PRICE	<b>7,70 €/Kg</b>

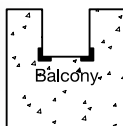
 Προφίλ με Κατεργασίες/Milling **9,70€/Kg**

**ΕΣΩΤΕΡΙΚΗ ΓΩΝΙΑ  
INTERNAL CORNER**

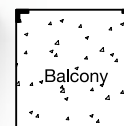
ΚΩΔ. / CODE	<b>F85-468*</b>
ΜΗΚΟΣ / LENGTH	30x30 cm
ΦΥΣΙΚΗ ΑΝΟΔΙΩΣΗ ANODIZE NATURAL	<b>103,05 €/pc</b>

**ΕΞΩΤΕΡΙΚΗ ΓΩΝΙΑ  
EXTERNAL CORNER**

ΚΩΔ. / CODE	<b>F85-480*</b>
ΜΗΚΟΣ / LENGTH	30x30 cm
ΦΥΣΙΚΗ ΑΝΟΔΙΩΣΗ ANODIZE NATURAL	<b>103,05 €/pc</b>

**Εξαρτήματα / Accessories**

**ΤΑΠΑ / END CAP**

ΚΩΔ. / CODE	<b>F85-489**</b>
ΜΗΚΟΣ / LENGTH	130x150 mm
ΦΥΣΙΚΗ ΑΝΟΔΙΩΣΗ ANODIZE NATURAL	<b>11,10 €/pc</b>
ΛΕΥΚΟ / ΜΑΥΡΟ WHITE / BLACK	<b>11,15 €/pc</b>

**ΤΑΠΑ / END CAP**

ΚΩΔ. / CODE	<b>F85-488**</b>
ΜΗΚΟΣ / LENGTH	77x130 mm
ΦΥΣΙΚΗ ΑΝΟΔΙΩΣΗ ANODIZE NATURAL	<b>6,60 €/pc</b>
ΛΕΥΚΟ / ΜΑΥΡΟ WHITE / BLACK	<b>6,70 €/pc</b>

**ΜΠΕΤΟΒΙΔΑ Ø12-110  
CONCRETE SCREW Ø12-110**

ΚΩΔ. / CODE	<b>EBM12-110</b>
ΤΙΜΗ / PRICE	<b>2,13 €/pc</b>

**ΠΕΙΡΟΣ / PIN**

ΚΩΔ. / CODE	<b>F85-481</b>
ΥΛ. / MATERIALE	Inox 304
ΤΙΜΗ / PRICE	<b>1,45 €/pc</b>

\* Περιλαμβάνουν τις βίδες αγκύρωσης/στερέωσης | Include the fixing bolts/anchors

\*\* Περιλαμβάνει την αυτοκόλλητη ταινία Lohman DuploColl 373 | Includes the adhesive tape Lohman DuploColl 373

 ■ ΕΞΑΡΤΗΜΑΤΑ: ΛΕΥΚΟ RAL, ΜΑΥΡΟ RAL, 420 ANODIC ΣΤΗΝ ΤΙΜΗ ΤΗΣ ΦΥΣΙΚΗΣ ΑΝΟΔΙΩΣΗΣ. ΓΙΑ ΤΑ ΥΠΟΛΟΙΠΑ RAL Η ΕΙΔΙΚΑ ΧΡΩΜΑΤΑ, ΕΠΙΠΛΕΟΝ ΕΠΙΒΑΡΥΝΣΗ 25% & 35% ΑΝΤΙΣΤΟΙΧΑ.  
 ACCESSORIES: COLORS WHITE RAL, BLACK RAL, 420 ANODIC SAME PRICE AS NATURAL ANODIZING. EXTRA CHARGE 25% AND 35% FOR ANY OTHER RAL COLORS AND SPECIAL COLORS RESPECTIVELY.

# L•line SIDE MOUNT

## SIDE MOUNT ≥1 KN/m



## SIDE MOUNT ≥1.7 KN/m



## SIDE MOUNT ≥1.7 KN/m



### ΠΡΟΦΙΛ ΒΑΣΗΣ / BASE U-PROFILE

ΚΩΔ. / CODE	<b>F85-1B63S</b> (10.10.4) (8.8.4)
ΒΑΡΟΣ / WEIGHT	7627 gr/m
ΜΗΚΟΣ / LENGTH	3 m
ΤΙΜΗ / PRICE	<b>7,70 €/Kg</b>
Προφίλ με Κατεργασίες/Milling <b>9,70 €/Kg</b>	



### ΕΣΩΤΕΡΙΚΗ ΓΩΝΙΑ INTERNAL CORNER

ΚΩΔ. / CODE	<b>F85-553*</b>
ΜΗΚΟΣ / LENGTH	30x30 cm
ΦΥΣΙΚΗ ΑΝΟΔΙΩΣΗ ANODIZE NATURAL	<b>85,85 €/pc</b>

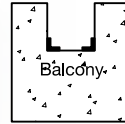

### ΕΣΩΤΕΡΙΚΗ ΓΩΝΙΑ EXTERNAL CORNER

ΚΩΔ. / CODE	<b>F85-554*</b>
ΜΗΚΟΣ / LENGTH	30x30 cm
ΦΥΣΙΚΗ ΑΝΟΔΙΩΣΗ ANODIZE NATURAL	<b>85,85 €/pc</b>

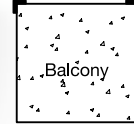

\*\* Περιλαμβάνει την αυτοκόλλητη ταινία Lohman DuploColl 373  
Includes the adhesive tape Lohman DuploColl 373

\* Περιλαμβάνουν τις βίδες αγκύρωσης/στερέωσης  
Include the fixing bolts/anchors



SIDE MOUNT with FIN  $\geq 3$  KN/m

## ΤΑΠΑ / END CAP

ΚΩΔ. / CODE	<b>F85-488</b>
ΜΗΚΟΣ / LENGTH	77x130 mm
ΦΥΣΙΚΗ ΑΝΟΔΙΩΣΗ ANODIZE NATURAL	<b>6,60 €/pc</b>



## ΠΕΙΡΟΣ / PIN

ΚΩΔ. / CODE	<b>F85-481</b>
ΤΙΜΗ / PRICE	<b>1,60 €/pc</b>

ΕΞΩΤΕΡΙΚΗ ΤΑΠΑ ΟΠΩΝ  
OUTSIDE SLOT CAP

ΚΩΔ. / CODE	<b>F85-475</b>
ΥΛ. / MATERIALE	PVC
ΤΙΜΗ / PRICE	<b>0,50 €/pc</b>

ΤΣΙΜΕΝΤΟΒΙΔΑ ΦΡΕΖΑΤΗ  
10X120 ΑΛΛΕΝ  
ALLEN TORX CONCRETE  
SCREW 10X120

ΚΩΔ. / CODE	<b>EBM-10120G/2</b>
ΤΙΜΗ / PRICE	<b>1,42 €/pc</b>

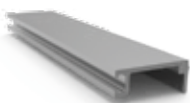
**ΕΣΩΤΕΡΙΚΟ ΚΑΠΑΚΙ ΒΑΣΗΣ  
BASE INSIDE COVER**

ΚΩΔ. / CODE	<b>F85-1K61</b> (10.10.4), (10.10.2)
ΒΑΡΟΣ / WEIGHT	178 gr/m
ΜΗΚΟΣ / LENGTH	6 m
ΤΙΜΗ / PRICE	<b>7,70 €/Kg</b>

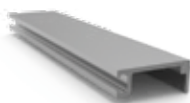
 Προφίλ με Κατεργασία/ Milling **9,70 €/Kg**

**ΕΣΩΤΕΡΙΚΟ ΚΑΠΑΚΙ ΒΑΣΗΣ  
BASE INSIDE COVER**

ΚΩΔ. / CODE	<b>F85-1K62</b> (8.8.4), (8.8.2)
ΒΑΡΟΣ / WEIGHT	194 gr/m
ΜΗΚΟΣ / LENGTH	6 m
ΤΙΜΗ / PRICE	<b>7,70 €/Kg</b>

**ΕΣΩΤΕΡΙΚΟ ΚΑΠΑΚΙ ΒΑΣΗΣ  
BASE INSIDE COVER**

ΚΩΔ. / CODE	<b>F85-1K66</b> (8.8.2), (8.8.4)
ΒΑΡΟΣ / WEIGHT	447 gr/m
ΜΗΚΟΣ / LENGTH	6 m
ΤΙΜΗ / PRICE	<b>7,70 €/Kg</b>

**ΕΣΩΤΕΡΙΚΟ ΚΑΠΑΚΙ ΒΑΣΗΣ  
BASE INSIDE COVER**

ΚΩΔ. / CODE	<b>F85-1K67</b> (10.10.2), (10.10.4)
ΒΑΡΟΣ / WEIGHT	425 gr/m
ΜΗΚΟΣ / LENGTH	6 m
ΤΙΜΗ / PRICE	<b>7,70 €/Kg</b>

**ΕΣΩΤΕΡΙΚΟ ΚΑΠΑΚΙ ΒΑΣΗΣ ΓΙΑ ΠΑΝΕΛ 15 MM  
BASE EXTERNAL COVER FOR 15 MM PANEL**

ΚΩΔ. / CODE	<b>F85-1K63</b>
ΒΑΡΟΣ / WEIGHT	475 gr/m
ΜΗΚΟΣ / LENGTH	6 m
ΤΙΜΗ / PRICE	<b>7,70 €/Kg</b>

**ΕΣΩΤΕΡΙΚΟ ΚΑΠΑΚΙ ΒΑΣΗΣ ΓΙΑ ΠΑΝΕΛ 10 MM  
BASE EXTERNAL COVER FOR 10 MM PANEL**

ΚΩΔ. / CODE	<b>F85-1K64</b>
ΒΑΡΟΣ / WEIGHT	460 gr/m
ΜΗΚΟΣ / LENGTH	6 m
ΤΙΜΗ / PRICE	<b>7,70 €/Kg</b>

**ΕΣΩΤΕΡΙΚΟ ΚΑΠΑΚΙ ΒΑΣΗΣ ΓΙΑ ΠΑΝΕΛ 5 MM  
BASE EXTERNAL COVER FOR 5 MM PANEL**

ΚΩΔ. / CODE	<b>F85-1K65</b>
ΒΑΡΟΣ / WEIGHT	349 gr/m
ΜΗΚΟΣ / LENGTH	6 m
ΤΙΜΗ / PRICE	<b>7,70 €/Kg</b>

**ΚΙΝΗΤΟ ΕΣΩΤΕΡΙΚΟ ΦΟΡΕΙΟ  
ADJUSTABLE CARRIAGE**

ΚΩΔ. / CODE	<b>F85-585</b>
ΒΑΡΟΣ / WEIGHT	117 gr
ΜΗΚΟΣ / LENGTH	70 mm
ΤΙΜΗ / PRICE	<b>3,65 €/pc</b>

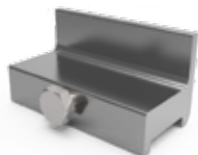
**ΣΤΑΘΕΡΟ ΕΣΩΤΕΡΙΚΟ ΦΟΡΕΙΟ  
INTERMEDIATE FIXED CARRIAGE**

ΚΩΔ. / CODE	<b>F85-483</b>
ΒΑΡΟΣ / WEIGHT	97 gr
ΜΗΚΟΣ / LENGTH	70 mm
ΤΙΜΗ / PRICE	<b>5,80 €/pc</b>

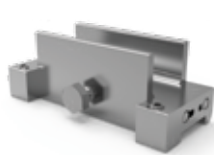
**ΚΙΝΗΤΟ ΕΣΩΤΕΡΙΚΟ ΦΟΡΕΙΟ  
INTERMEDIATE MOVABLE CARRIAGE**

ΚΩΔ. / CODE	<b>F85-587</b>
ΒΑΡΟΣ / WEIGHT	200 gr
ΜΗΚΟΣ / LENGTH	100 mm
ΤΙΜΗ / PRICE	<b>15,60 €/pc</b>

**ΛΑΣΤΙΧΟ ΑΝΤΙΣΤΗΡΙΞΗΣ  
COUNTER-BALANCE GASKET**

ΚΩΔ. / CODE	<b>F85-477</b> (5.5.4, 6.6.4, 8.8.4)
ΥΛ. / MATERIALE	PVC
ΜΗΚΟΣ / LENGTH	100 m
ΣΚΛΗΡΟΤΗΤΑ/HARDNESS	100 shore
ΤΙΜΗ / PRICE	<b>1,45 €/m</b>

**ΚΥΡΙΟ ΛΑΣΤΙΧΟ  
MAIN GASKET**

ΚΩΔ. / CODE	<b>F85-478</b>
ΜΗΚΟΣ / LENGTH	100 m
ΤΙΜΗ / PRICE	<b>0,59 €/m</b>

**ΕΝΔΙΑΜΕΣΗ ΣΦΗΝΑ  
INTERMEDIATE WEDGE**

ΚΩΔ. / CODE	ΤΙΜΗ / PRICE
<b>F85-486 Ø18</b> (10.10.4)	<b>0,80 €/pc</b>
<b>F85-487 Ø20</b> (10.10.2)	<b>0,70 €/pc</b>
<b>F85-484 Ø22</b> (8.8.4)	<b>0,85 €/pc</b>
<b>F85-485 Ø25</b> (8.8.2)	<b>1,00 €/pc</b>
ΥΛ. / MATERIALE	POM
ΜΗΚΟΣ / LENGTH	70 mm

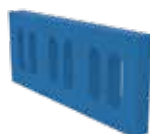
**ΣΦΗΝΑ ΑΝΤΙΣΤΗΡΙΞΗΣ  
F85-1B61/1B62/1B63  
COMPACT WEDGE FOR  
F85-1B61/1B62/1B63**

ΚΩΔ. / CODE	<b>F85-577</b> (5.5.4, 6.6.4, 8.8.4)
ΤΙΜΗ / PRICE	<b>0,75 €/pc</b>

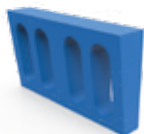
**ΣΦΗΝΑ ΑΝΤΙΣΤΗΡΙΞΗΣ F85-1B64  
COMPACT WEDGE FOR F85-1B64**

ΚΩΔ. / CODE	<b>F85-578</b> (8.8.4, 10.10.4)
ΤΙΜΗ / PRICE	<b>0,81 €/pc</b>

**ΒΑΣΙΚΗ ΣΦΗΝΑ  
BASIC WEDGE**

ΚΩΔ. / CODE	ΤΙΜΗ / PRICE
<b>F85-573</b> (8.8.2)	<b>0,65 €/pc</b>
<b>F85-473</b> (8.8.4)	<b>0,70 €/pc</b>
<b>F85-574</b> (10.10.2)	<b>0,60 €/pc</b>
<b>F85-474</b> (10.10.4)	<b>0,60 €/pc</b>
ΥΛ. / MATERIALE	PVC
ΜΗΚΟΣ / LENGTH	70 mm

**ΣΤΗΡΙΓΜΑ ΤΖΑΜΙΟΥ  
GLASS SUPPORT**

ΚΩΔ. / CODE	ΤΙΜΗ / PRICE
<b>F85-571</b> (8.8.2)	<b>0,50 €/pc</b>
<b>F85-471</b> (8.8.4)	<b>0,50 €/pc</b>
<b>F85-572</b> (10.10.2)	<b>0,40 €/pc</b>
<b>F85-472</b> (10.10.4)	<b>0,40 €/pc</b>
ΥΛ. / MATERIALE	PVC
ΜΗΚΟΣ / LENGTH	70 mm

**ΓΕΡΜΑΝΟΠΟΛΥΓΩΝΟ N013  
(ΠΑΧΟΣ ΚΕΦ. 5.2 MM)  
CURVED WRENCH N013**

ΚΩΔ. / CODE	<b>F85-561</b>
ΤΙΜΗ / PRICE	<b>26,90 €/pc</b>

# Slim•line HD

Προφίλ & Εξαρτήματα / Profiles & Accessories

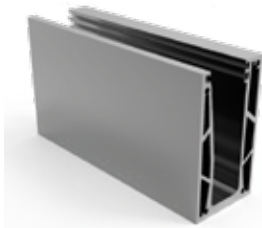

ΠΡΟΦΙΛ ΒΑΣΗ SLIM LINE  
BASE PROFILE SLIM LINE

ΚΩΔ. / CODE	<b>F85-1B75T1</b>
ΒΑΡΟΣ / WEIGHT	5078 gr/m
ΜΗΚΟΣ / LENGTH	6 m
ΤΙΜΗ / PRICE	<b>7,70 €/Kg</b>



ΕΣΩΤΕΡΙΚΗ ΓΩΝΙΑ SLIM LINE HD  
INTERNAL CORNER SLIM LINE HD

ΚΩΔ. / CODE	<b>F85-562</b>
ΜΗΚΟΣ / LENGTH	20x20 cm
ΦΥΣΙΚΗ ΑΝΟΔΙΩΣΗ ANODIZE NATURAL	<b>53,25 €/pc</b>
ΓΥΑΛΙΣΤΕΡΗ ΑΝΟΔΙΩΣΗ F50 ANODIZE GLOSS F50	<b>56,80 €/pc</b>

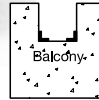

ΕΞΩΤΕΡΙΚΗ ΓΩΝΙΑ SLIM LINE HD  
EXTERNAL CORNER SLIM LINE HD

ΚΩΔ. / CODE	<b>F85-563</b>
ΜΗΚΟΣ / LENGTH	20x20 cm
ΦΥΣΙΚΗ ΑΝΟΔΙΩΣΗ ANODIZE NATURAL	<b>53,25 €/pc</b>
ΓΥΑΛΙΣΤΕΡΗ ΑΝΟΔΙΩΣΗ F50 ANODIZE GLOSS F50	<b>56,80 €/pc</b>



ΛΑΣΤΙΚΟ ΑΝΤΙΣΤΗΡΙΞΗΣ  
COUNTER-BALANCE GASKET

ΚΩΔ. / CODE	<b>F85-417</b> (10.10.4)
ΥΛ. / MATERIAL	PVC
ΤΙΜΗ / PRICE	<b>0,75 €/m</b>



ΛΑΣΤΙΚΟ ΣΦΗΝΑ ΤΖΑΜΙΟΥ  
GASKET FOR BASE FOR GLASS

<b>F85-448</b> (6.6.4)	<b>3,25 €/m</b>
<b>F85-449</b> (8.8.4, 10.10.4)	<b>2,48 €/m</b>
ΥΛ. / MATERIAL	EPDM



ΛΑΣΤΙΚΟ ΣΦΗΝΑ ΤΖΑΜΙΟΥ  
GASKET FOR BASE

ΚΩΔΙΚΟΣ / CODE	<b>F85-453</b> (5.5.4)
ΥΛ. / MATERIAL	EPDM
ΤΙΜΗ / PRICE	<b>3,85 €/m</b>



ΛΑΣΤΙΚΟ ΑΝΤΙΣΤΗΡΙΞΗΣ  
COUNTER-BALANCE GASKET

ΚΩΔ. / CODE	<b>F85-477</b> (5.5.4, 6.6.4, 8.8.4)
ΥΛ. / MATERIAL	PVC
ΜΗΚΟΣ / LENGTH	100 m
ΣΚΛΗΡΟΤΗΤΑ/HARDNESS	100 shore
ΤΙΜΗ / PRICE	<b>1,42 €/m</b>



ΤΑΠΑ ΒΑΣΗΣ TYPE SLIM LINE  
END CAP FOR TYPE SLIM LINE

ΚΩΔ. / CODE	<b>F85-497</b>
ΤΙΜΗ / PRICE	<b>13,00 €/paa</b>

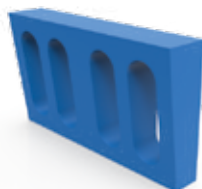

ΒΑΣΙΚΗ ΣΦΗΝΑ L70MM  
BASIC WEDGE

<b>F85-575</b> (5.5.4, 6.6.4)	<b>0,50 €/pc</b>
<b>F85-576</b> (8.8.4, 10.10.4)	<b>0,45 €/pc</b>

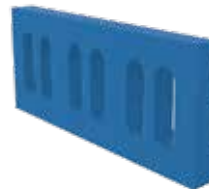

ΣΦΗΝΑ ΑΝΤΙΣΤΗΡΙΞΗΣ  
COUNTER-BALANCE WEDGE PVC

ΚΩΔΙΚΟΣ / CODE	<b>F85-577</b> (5.5.4, 6.6.4, 8.8.4)
ΤΙΜΗ / PRICE	<b>0,80 €/pc</b>



ΣΦΗΝΑ ΑΝΤΙΣΤΗΡΙΞΗΣ  
COUNTER-BALANCE WEDGE PVC

ΚΩΔΙΚΟΣ / CODE	<b>F85-581</b> (10.10.4)
ΤΙΜΗ / PRICE	<b>0,70 €/pc</b>



ΠΛΑΣΤΙΚΟ ΣΤΗΡΙΓΜΑ ΥΑΛΟΠΙΝΑΚΑ  
PLASTIC GLASS SUPPORT

<b>F85-591</b> (5.5.4)	<b>0,70 €/pc</b>
<b>F85-592</b> (6.6.4)	<b>0,70 €/pc</b>
<b>F85-593</b> (8.8.4)	<b>0,70 €/pc</b>
ΥΛ. / MATERIALE	PVC



ΠΛΑΣΤΙΚΟ ΣΤΗΡΙΓΜΑ ΥΑΛΟΠΙΝΑΚΑ  
PLASTIC GLASS SUPPORT

ΚΩΔΙΚΟΣ / CODE	<b>F85-594</b> (10.10.4)
ΥΛ. / MATERIALE	PVC
ΤΙΜΗ / PRICE	<b>0,70 €/pc</b>



ΠΙΡΟΣ / PIN

ΚΩΔ. / CODE	<b>F85-481</b>
ΥΛ. / MATERIAL	Inox 304
ΤΙΜΗ / PRICE	<b>1,45 €/pc</b>



ΤΣΙΜΕΝΟΒΙΔΑ ΦΡΕΖΑΤΗ  
10X120 ΑΛΛΕΝ  
ALLEN TORX CONCRETE  
SCREW 10X120

ΚΩΔ. / CODE	<b>EBM-10120G/2</b>
ΤΙΜΗ / PRICE	<b>1,42 €/pc</b>

# Slim•line

## TOP MOUNT

### Βάσεις στήριξης υαλοπίνακα / Glass supporting bases

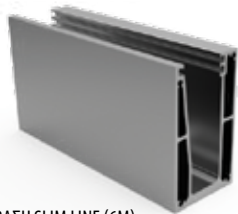
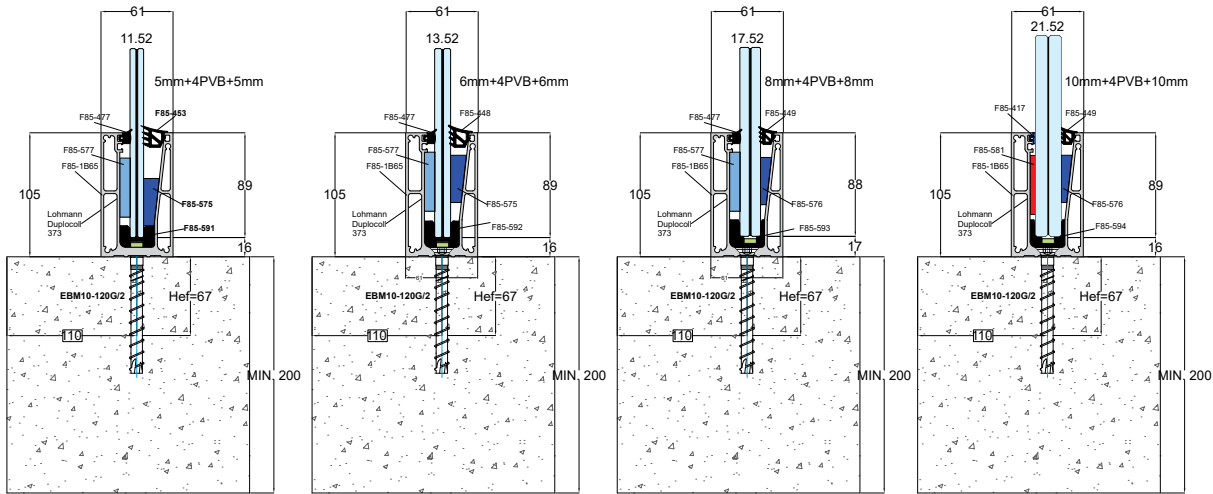

ΠΡΟΦΙΛ ΒΑΣΗ SLIM LINE (6M)  
BASE PROFILE SLIM LINE (6M)

ΚΩΔ. / CODE	<b>F85-1B65T1</b>
ΒΑΡΟΣ / WEIGHT	3.837 gr/m
ΤΙΜΗ / PRICE	<b>7,70 €/Kg</b>

Προφίλ με Κατεργασίες/Milling **9,70 €/Kg**

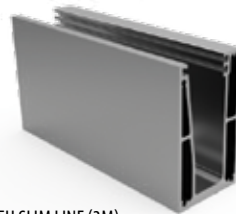

ΠΡΟΦΙΛ ΒΑΣΗ SLIM LINE (3M)  
BASE PROFILE SLIM LINE (3M)

ΚΩΔ. / CODE	<b>F85-1B65T2</b>
ΒΑΡΟΣ / WEIGHT	3.837 gr/m
ΤΙΜΗ / PRICE	<b>7,70 €/Kg</b>

Προφίλ με Κατεργασίες/Milling **9,70 €/Kg**

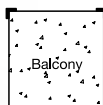

ΕΞΩΤΕΡΙΚΗ ΓΩΝΙΑ SLIM LINE  
EXTERNAL CORNER SLIM LINE

ΚΩΔ. / CODE	<b>F85-558</b>
ΜΗΚΟΣ / LENGTH	20x20 cm
ΦΥΣΙΚΗ ΑΝΟΔΙΩΣΗ ANODIZE NATURAL	<b>48,25 €/pc</b>
ΓΥΑΛΙΣΤΕΡΗ ΑΝΟΔΙΩΣΗ F50 ANODIZE GLOSS F50	<b>50,60 €/pc</b>

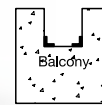

ΕΣΩΤΕΡΙΚΗ ΓΩΝΙΑ SLIM LINE  
INTERNAL CORNER SLIM LINE

ΚΩΔ. / CODE	<b>F85-559</b>
ΜΗΚΟΣ / LENGTH	20x20 cm
ΦΥΣΙΚΗ ΑΝΟΔΙΩΣΗ ANODIZE NATURAL	<b>48,25 €/pc</b>
ΓΥΑΛΙΣΤΕΡΗ ΑΝΟΔΙΩΣΗ F50 ANODIZE GLOSS F50	<b>50,60 €/pc</b>



ΛΑΣΤΙΧΟ ΑΝΤΙΣΤΗΡΙΞΗΣ  
COUNTER-BALANCE GASKET

ΚΩΔ. / CODE	<b>F85-417</b> (10.10.4)
ΥΛ. / MATERIALE	PVC
ΤΙΜΗ / PRICE	<b>0,75 €/m</b>



ΛΑΣΤΙΧΟ ΣΦΗΝΑ ΤΖΑΜΙΟΥ  
GASKET FOR BASE FOR GLASS

ΚΩΔ. / CODE	<b>F85-448</b> (6.6.4)
ΥΛ. / MATERIALE	EPDM
ΤΙΜΗ / PRICE	<b>3,25 €/m</b>



ΛΑΣΤΙΧΟ ΣΦΗΝΑ ΤΖΑΜΙΟΥ  
GASKET FOR BASE FOR GLASS

ΚΩΔ. / CODE	<b>F85-449</b> (8.8.4, 10.10.4)
ΥΛ. / MATERIALE	EPDM
ΤΙΜΗ / PRICE	<b>2,48 €/m</b>



ΛΑΣΤΙΧΟ ΣΦΗΝΑ ΤΖΑΜΙΟΥ  
GASKET FOR BASE

ΚΩΔ. / CODE	<b>F85-453</b> (5.5.4)
ΥΛ. / MATERIALE	EPDM
ΤΙΜΗ / PRICE	<b>3,85 €/m</b>



ΛΑΣΤΙΧΟ ΑΝΤΙΣΤΗΡΙΞΗΣ  
COUNTER-BALANCE GASKET

ΚΩΔ. / CODE	<b>F85-477</b> (5.5.4, 6.6.4, 8.8.4)
ΥΛ. / MATERIALE	PVC
ΜΗΚΟΣ / LENGTH	100 m
ΣΚΛΗΡΟΤΗΤΑ/HARDNESS	100 shore
ΤΙΜΗ / PRICE	<b>1,42 €/m</b>



ΤΑΠΑ ΒΑΣΗΣ TYPE SLIM LINE  
END CAP FOR TYPE SLIM LINE

ΚΩΔ. / CODE	<b>F85-495</b>
ΦΥΣΙΚΗ ΑΝΟΔΙΩΣΗ ANODIZE NATURAL	<b>5,70 €/pc</b>
ΓΥΑΛΙΣΤΕΡΗ ΑΝΟΔΙΩΣΗ F50 ANODIZE GLOSS F50	<b>6,30 €/pc</b>
ΛΕΥΚΟ / ΜΑΥΡΟ WHITE / BLACK	<b>5,80 €/pc</b>

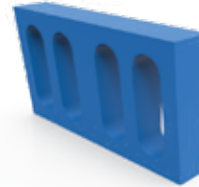

ΒΑΣΙΚΗ ΣΦΗΝΑ L70MM  
BASIC WEDGE

ΚΩΔ. / CODE	<b>F85-575</b> (5.5.4, 6.6.4)
ΤΙΜΗ / PRICE	<b>0,50 €/pc</b>



ΠΛΑΣΤΙΚΗ ΣΦΗΝΑ ΤΖΑΜΙΟΥ L70  
BASIC WEDGE FOR GLASS

ΚΩΔ. / CODE	<b>F85-576</b> (8.8.4, 10.10.4)
ΤΙΜΗ / PRICE	<b>0,45 €/pc</b>

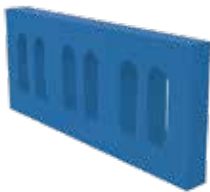

ΣΦΗΝΑ ΑΝΤΙΣΤΗΡΙΞΗΣ  
COUNTER-BALANCE WEDGE PVC

ΚΩΔ. / CODE	<b>F85-577</b> (5.5.4, 6.6.4, 8.8.4)
ΤΙΜΗ / PRICE	<b>0,80 €/pc</b>



ΣΦΗΝΑ ΑΝΤΙΣΤΗΡΙΞΗΣ  
COUNTER-BALANCE WEDGE PVC

ΚΩΔ. / CODE	<b>F85-581</b> (10.10.4)
ΤΙΜΗ / PRICE	<b>0,70 €/pc</b>



ΠΛΑΣΤΙΚΟ ΣΤΗΡΙΓΜΑ ΥΑΛΟΠΙΝΑΚΑ  
PLASTIC GLASS SUPPORT

ΚΩΔ. / CODE	<b>F85-591</b> (5.5.4)
ΥΛ. / MATERIALE	PVC
ΤΙΜΗ / PRICE	<b>0,70 €/pc</b>



ΠΛΑΣΤΙΚΟ ΣΤΗΡΙΓΜΑ ΥΑΛΟΠΙΝΑΚΑ  
PLASTIC GLASS SUPPORT

ΚΩΔ. / CODE	<b>F85-592</b> (6.6.4)
ΥΛ. / MATERIALE	PVC
ΤΙΜΗ / PRICE	<b>0,70 €/pc</b>



ΠΛΑΣΤΙΚΟ ΣΤΗΡΙΓΜΑ ΥΑΛΟΠΙΝΑΚΑ  
PLASTIC GLASS SUPPORT

ΚΩΔ. / CODE	<b>F85-593</b> (8.8.4)
ΥΛ. / MATERIALE	PVC
ΤΙΜΗ / PRICE	<b>0,70 €/pc</b>



ΠΛΑΣΤΙΚΟ ΣΤΗΡΙΓΜΑ ΥΑΛΟΠΙΝΑΚΑ  
PLASTIC GLASS SUPPORT

ΚΩΔ. / CODE	<b>F85-594</b> (10.10.4)
ΥΛ. / MATERIALE	PVC
ΤΙΜΗ / PRICE	<b>0,70 €/pc</b>



ΠΕΙΡΟΣ / PIN

ΚΩΔ. / CODE	<b>F85-481</b>
ΥΛ. / MATERIALE	Inox 304
ΤΙΜΗ / PRICE	<b>1,45 €/pc</b>



ΤΣΙΜΕΝΤΟΒΙΔΑ ΦΡΕΖΑΤΗ 10X120 ΑΛΛΕΝ  
ALLEN TORX CONCRETE SCREW 10X120

ΚΩΔ. / CODE	<b>EBM-10120G/2</b>
ΤΙΜΗ / PRICE	<b>1,52 €/pc</b>



ΕΚΤΟΝΟΥΜΕΝΟ ΜΕΤΑΛ. ΟΥΠΑ  
EXPANSION PLUG

ΚΩΔ. / CODE	<b>EB01M-1060</b>
ΤΙΜΗ / PRICE	<b>1,37 €/pc</b>



ΒΙΔΑ DIN 7991 M10X70 INOX  
SCREW DIN 7991 M10X70 INOX

ΚΩΔ. / CODE	<b>D7991-00231</b>
ΤΙΜΗ / PRICE	<b>0,44 €/pc</b>

# Slim•line

## SIDE MOUNT & STAIRS

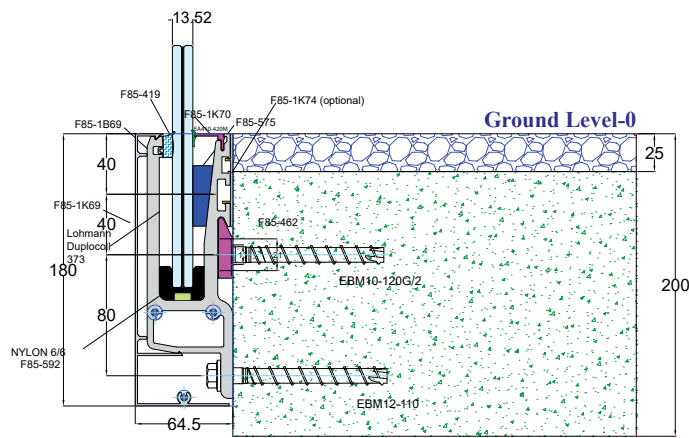
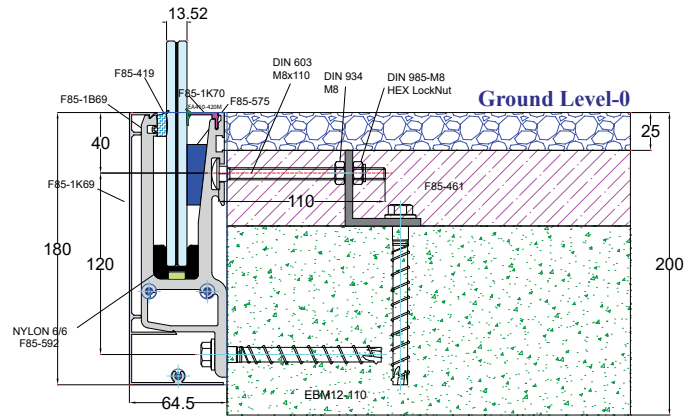





ΒΑΣΗ SLIM LINE (3M)  
BASE PROFILE SLIM LINE (3M)

ΚΩΔ. / CODE	<b>F85-1B69S2</b>
ΒΑΡΟΣ / WEIGHT	7734 gr/m
ΤΙΜΗ / PRICE	<b>7,70 €/Kg</b>

Προφύλι με Κατεργασία/ Milling **9,70 €/Kg**



ΚΑΠΑΚΙ ΒΑΣΗΣ  
BASE COVER PROFILE

ΚΩΔ. / CODE	<b>F85-1K69</b>
ΒΑΡΟΣ / WEIGHT	1375 gr/m
ΤΙΜΗ / PRICE	<b>7,70 €/Kg</b>



ΕΣΩΤΕΡΙΚΗ ΓΩΝΙΑ  
INTERNAL CORNER

ΚΩΔ. / CODE	<b>F85-541</b>
ΜΗΚΟΣ / LENGTH	30x30 cm
ΦΥΣΙΚΗ ΑΝΟΔΙΩΣΗ ANODIZE NATURAL	<b>58,95 €/pc</b>
ΓΥΑΛΙΣΤΕΡΗ ΑΝΟΔΙΩΣΗ F50 ANODIZE GLOSS F50	<b>58,70 €/pc</b>



ΕΞΩΤΕΡΙΚΗ ΓΩΝΙΑ  
EXTERNAL CORNER

ΚΩΔ. / CODE	<b>F85-542</b>
ΜΗΚΟΣ / LENGTH	30x30 cm
ΦΥΣΙΚΗ ΑΝΟΔΙΩΣΗ ANODIZE NATURAL	<b>58,95 €/pc</b>
ΓΥΑΛΙΣΤΕΡΗ ΑΝΟΔΙΩΣΗ F50 ANODIZE GLOSS F50	<b>58,70 €/pc</b>



ΚΑΠΑΚΙ ΤΕΛΕΙΩΜΑΤΟΣ  
END COVER PROFILE

ΚΩΔ. / CODE	<b>F85-1K70</b> 5.5.4, 6.6.4
ΒΑΡΟΣ / WEIGHT	134 gr/m
ΜΗΚΟΣ / LENGTH	6 m
ΤΙΜΗ / PRICE	<b>7,70 €/Kg</b>



ΚΑΠΑΚΙ ΤΕΛΕΙΩΜΑΤΟΣ  
END COVER PROFILE

ΚΩΔ. / CODE	<b>F85-1K72</b> 8.8.4, 10.10.4
ΒΑΡΟΣ / WEIGHT	110 gr/m
ΜΗΚΟΣ / LENGTH	6 m
ΤΙΜΗ / PRICE	<b>7,70 €/Kg</b>



ΚΑΠΑΚΙ ΣΚΑΛΑΣ  
STAIRS COVER PROFILE

ΚΩΔ. / CODE	<b>F85-1K74</b>
ΒΑΡΟΣ / WEIGHT	280 gr/m
ΜΗΚΟΣ / LENGTH	6 m
ΤΙΜΗ / PRICE	<b>7,70 €/Kg</b>



ΛΑΣΤΙΧΟ ΑΝΤΙΣΤΗΡΙΞΗΣ  
COUNTER-BALANCE GASKET

ΚΩΔ. / CODE	<b>F85-417</b> (10.10.4)
ΥΛ. / MATERIALE	PVC
ΤΙΜΗ / PRICE	<b>0,75 €/m</b>



ΛΑΣΤΙΧΟ ΑΝΤΙΣΤΗΡΙΞΗΣ  
COUNTER-BALANCE GASKET

ΚΩΔ. / CODE	<b>F85-418</b> (10.10.4)
ΥΛ. / MATERIALE	PVC
ΤΙΜΗ / PRICE	<b>0,97 €/m</b>



ΛΑΣΤΙΧΟ ΑΝΤΙΣΤΗΡΙΞΗΣ  
COUNTER-BALANCE GASKET

ΚΩΔ. / CODE	<b>F85-419</b> (5.5.4, 6.6.4, 8.8.4)
ΥΛ. / MATERIALE	PVC
ΤΙΜΗ / PRICE	<b>2,38 €/m</b>



ΕΞΑΡΤΗΜΑ ΣΤΗΡΙΞΗΣ ΒΑΣΗΣ  
COMPONENT FOR BASE

ΚΩΔ. / CODE	<b>F85-461</b>
ΤΙΜΗ / PRICE	<b>7,20 €/pc</b>



ΚΡΕΜΑΣΤΡΑ ΣΤΗΡΙΞΗΣ  
HANGER COMPONENT

ΚΩΔ. / CODE	<b>F85-462</b>
ΜΗΚΟΣ / LENGTH	1 m
ΤΙΜΗ / PRICE	<b>19,40 €/pc</b>



ΛΑΣΤΙΧΟ ΑΝΤΙΣΤΗΡΙΞΗΣ  
COUNTER-BALANCE GASKET

ΚΩΔ. / CODE	<b>F85-477</b> (5.5.4, 6.6.4, 8.8.4)
ΥΛ. / MATERIALE	PVC
ΜΗΚΟΣ / LENGTH	100 m
ΣΚΛΗΡΟΤΗΤΑ/HARDNESS	100 shore
ΤΙΜΗ / PRICE	<b>1,42 €/m</b>



ΠΕΙΡΟΣ / PIN

ΚΩΔ. / CODE	<b>F85-481</b>
ΥΛ. / MATERIALE	Inox 304
ΤΙΜΗ / PRICE	<b>1,35 €/pc</b>



ΤΑΠΑ ΒΑΣΗΣ / END CAP

ΚΩΔ. / CODE	<b>F85-496</b>
ΤΙΜΗ / PRICE	<b>10,20 €/pc</b>
ΦΥΣΙΚΗ ΑΝΟΔΙΩΣΗ ANODIZE NATURAL	<b>9,20 €/pc</b>
ΓΥΑΛΙΣΤΕΡΗ ΑΝΟΔΙΩΣΗ F50 ANODIZE GLOSS F50	<b>9,30 €/pc</b>
ΛΕΥΚΟ / ΜΑΥΡΟ WHITE / BLACK	<b>9,00 €/pc</b>

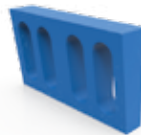

ΒΑΣΙΚΗ ΣΦΗΝΑ L70MM  
BASIC WEDGE

ΚΩΔ. / CODE	<b>F85-575</b> (5.5.4, 6.6.4)
ΤΙΜΗ / PRICE	<b>0,50 €/pc</b>



ΠΛΑΣΤΙΚΗ ΣΦΗΝΑ ΤΖΑΜΙΟΥ L70  
BASIC WEDGE

ΚΩΔ. / CODE	<b>F85-576</b> (8.8.4, 10.10.4)
ΤΙΜΗ / PRICE	<b>0,45 €/pc</b>



ΣΦΗΝΑ ΑΝΤΙΣΤΗΡΙΞΗΣ  
COUNTER-BALANCE WEDGE PVC

ΚΩΔ. / CODE	<b>F85-577</b> (5.5.4, 6.6.4, 8.8.4)
ΤΙΜΗ / PRICE	<b>0,80 €/pc</b>



ΣΦΗΝΑ ΑΝΤΙΣΤΗΡΙΞΗΣ  
COUNTER-BALANCE WEDGE PVC

ΚΩΔ. / CODE **F85-581** (10.10.4)

ΤΙΜΗ / PRICE **0,70 €/pc**



ΠΛΑΣΤΙΚΟ ΣΤΗΡΙΓΜΑ ΥΑΛΟΠΙΝΑΚΑ  
PLASTIC GLASS SUPPORT

ΚΩΔ. / CODE **F85-591** (5.5.4)

ΥΛ. / MATERIALE PVC

ΤΙΜΗ / PRICE **0,70 €/pc**



ΠΛΑΣΤΙΚΟ ΣΤΗΡΙΓΜΑ ΥΑΛΟΠΙΝΑΚΑ  
PLASTIC GLASS SUPPORT

ΚΩΔ. / CODE **F85-592** (6.6.4)

ΥΛ. / MATERIALE PVC

ΤΙΜΗ / PRICE **0,70 €/pc**



ΠΛΑΣΤΙΚΟ ΣΤΗΡΙΓΜΑ ΥΑΛΟΠΙΝΑΚΑ  
PLASTIC GLASS SUPPORT

ΚΩΔ. / CODE **F85-593** (8.8.4)

ΥΛ. / MATERIALE PVC

ΤΙΜΗ / PRICE **0,70 €/pc**



ΠΛΑΣΤΙΚΟ ΣΤΗΡΙΓΜΑ ΥΑΛΟΠΙΝΑΚΑ  
PLASTIC GLASS SUPPORT

ΚΩΔ. / CODE **F85-594** (10.10.4)

ΥΛ. / MATERIALE PVC

ΤΙΜΗ / PRICE **0,70 €/pc**



ΤΣΙΜΕΝΟΒΙΔΑ ΦΡΕΖΑΤΗ 10X120 ΑΛΛΕΝ  
ALLEN TORX CONCRETE SCREW 10X120

ΚΩΔ. / CODE **EBM-10120G/2**

ΤΙΜΗ / PRICE **1,52 €/pc**



ΛΑΣΤΙΚΟ ΣΦΗΝΑ ΤΖΑΜΙΟΥ 1MM  
GLAZING GASKET 1MM

ΚΩΔ. / CODE **EA410-420M**

ΥΛ. / MATERIALE EPDM

ΜΗΚΟΣ / LENGTH 350 m

ΤΙΜΗ / PRICE **0,37 €/m**



ΛΑΣΤΙΚΟ ΣΦΗΝΑ ΤΖΑΜΙΟΥ  
GLAZING GASKET

ΚΩΔ. / CODE **US521-01**

(5.5.4, 8.8.4, 10.10.4)

ΥΛ. / MATERIALE EPDM

ΤΙΜΗ / PRICE **0,65 €/m**



ΜΠΕΤΟΒΙΔΑ Ø12-110  
CONCRETE SCREW Ø12-110

ΚΩΔ. / CODE **EBM12-110**

ΤΙΜΗ / PRICE **2,13 €/pc**

# Slim•line

IN-FLOOR

55.4PVB=11.52mm

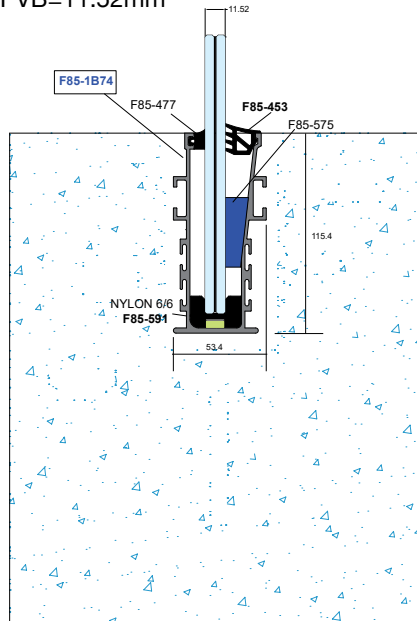

55.4PVB=11.52mm

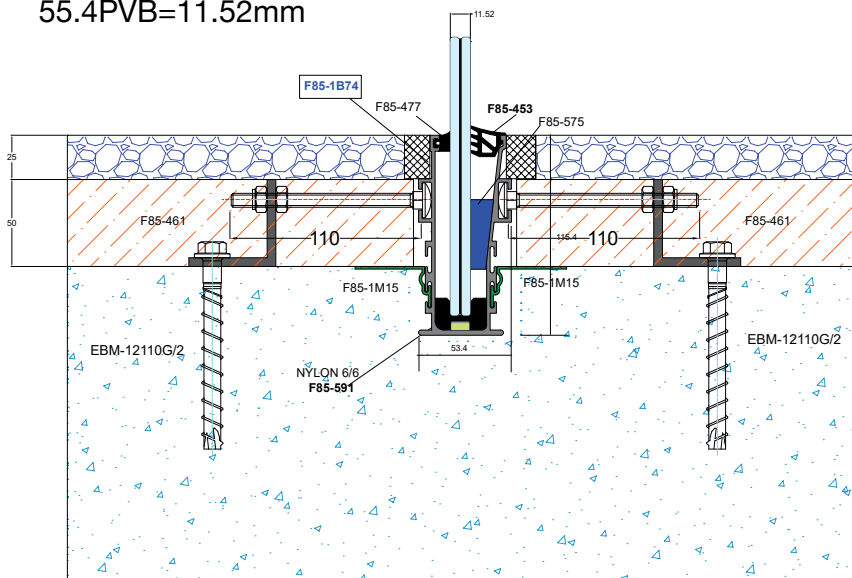

## Slim•line

## IN-FLOOR

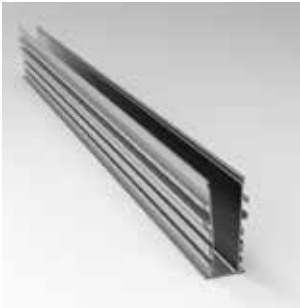

ΠΡΟΦΙΛ ΒΑΣΗΣ / BASE PROFILE

ΚΩΔ. / CODE	<b>F85-1B74</b>
ΒΑΡΟΣ / WEIGHT	2532 gr/m
ΤΙΜΗ / PRICE	<b>7,70 €/Kg</b>

ΛΑΣΤΙΚΟ ΑΝΤΙΣΤΗΡΙΞΗΣ  
COUNTER-BALANCE GASKET

ΚΩΔ. / CODE	<b>F85-417</b> (10.10.4)
ΥΛ. / MATERIALE	PVC
ΤΙΜΗ / PRICE	<b>0,75 €/m</b>

ΛΑΣΤΙΚΟ ΣΦΗΝΑ ΤΖΑΜΙΟΥ  
GASKET FOR BASE FOR GLASS

ΚΩΔ. / CODE	<b>F85-448</b> (6.6.4)
ΥΛ. / MATERIALE	EPDM
ΤΙΜΗ / PRICE	<b>3,25 €/m</b>

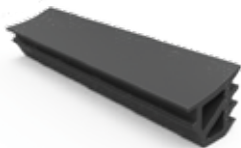
ΛΑΣΤΙΚΟ ΣΦΗΝΑ ΤΖΑΜΙΟΥ  
GASKET FOR BASE FOR GLASS

ΚΩΔ. / CODE	<b>F85-449</b> (8.8.4, 10.10.4)
ΥΛ. / MATERIALE	EPDM
ΤΙΜΗ / PRICE	<b>2,45 €/m</b>

ΛΑΣΤΙΚΟ ΣΦΗΝΑ ΤΖΑΜΙΟΥ  
GASKET FOR BASE FOR GLASS

ΚΩΔ. / CODE	<b>F85-453</b> (5.5.4)
ΥΛ. / MATERIALE	EPDM
ΤΙΜΗ / PRICE	<b>3,85 €/m</b>

ΕΞΑΡΤΗΜΑ ΣΤΗΡΙΞΗΣ ΒΑΣΗΣ  
COMPONENT FOR BASE

ΚΩΔ. / CODE	<b>F85-461</b>
ΤΙΜΗ / PRICE	<b>7,20 €/pc</b>

ΛΑΣΤΙΚΟ ΑΝΤΙΣΤΗΡΙΞΗΣ  
COUNTER-BALANCE GASKET

ΚΩΔ. / CODE	<b>F85-477</b> (5.5.4, 6.6.4, 8.8.4)
ΥΛ. / MATERIALE	PVC
ΜΗΚΟΣ / LENGTH	100 m
ΣΚΛΗΡΟΤΗΤΑ/HARDNESS	100 shore
ΤΙΜΗ / PRICE	<b>1,42 €/m</b>

ΒΑΣΙΚΗ ΣΦΗΝΑ L70MM  
BASIC WEDGE

ΚΩΔ. / CODE	<b>F85-575</b> (5.5.4, 6.6.4)
ΤΙΜΗ / PRICE	<b>0,50 €/pc</b>

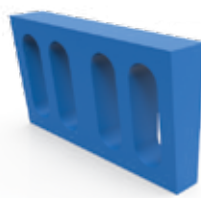
ΠΛΑΣΤΙΚΗ ΣΦΗΝΑ ΤΖΑΜΙΟΥ L70  
BASIC WEDGE FOR GLASS

ΚΩΔ. / CODE	<b>F85-576</b> (8.8.4, 10.10.4)
ΤΙΜΗ / PRICE	<b>0,45 €/pc</b>

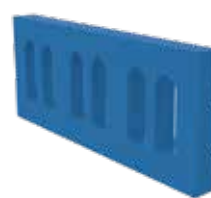
ΣΦΗΝΑ ΑΝΤΙΣΤΗΡΙΞΗΣ  
COUNTER-BALANCE WEDGE PVC

ΚΩΔ. / CODE	<b>F85-577</b> (5.5.4, 6.6.4, 8.8.4)
ΤΙΜΗ / PRICE	<b>0,80 €/pc</b>

ΣΦΗΝΑ ΑΝΤΙΣΤΗΡΙΞΗΣ  
COUNTER-BALANCE WEDGE PVC

ΚΩΔ. / CODE	<b>F85-581</b> (10.10.4)
ΤΙΜΗ / PRICE	<b>0,70 €/pc</b>

ΠΛΑΣΤΙΚΟ ΣΤΗΡΙΓΜΑ ΥΑΛΟΠΙΝΑΚΑ  
PLASTIC GLASS SUPPORT

ΚΩΔ. / CODE	<b>F85-591</b> (5.5.4)
ΥΛ. / MATERIALE	PVC
ΤΙΜΗ / PRICE	<b>0,70 €/pc</b>

ΠΛΑΣΤΙΚΟ ΣΤΗΡΙΓΜΑ ΥΑΛΟΠΙΝΑΚΑ  
PLASTIC GLASS SUPPORT

ΚΩΔ. / CODE	<b>F85-592</b> (6.6.4)
ΥΛ. / MATERIALE	PVC
ΤΙΜΗ / PRICE	<b>0,70 €/pc</b>

ΠΛΑΣΤΙΚΟ ΣΤΗΡΙΓΜΑ ΥΑΛΟΠΙΝΑΚΑ  
PLASTIC GLASS SUPPORT

ΚΩΔ. / CODE	<b>F85-593</b> (8.8.4)
ΥΛ. / MATERIALE	PVC
ΤΙΜΗ / PRICE	<b>0,70 €/pc</b>

ΠΛΑΣΤΙΚΟ ΣΤΗΡΙΓΜΑ ΥΑΛΟΠΙΝΑΚΑ  
PLASTIC GLASS SUPPORT

ΚΩΔ. / CODE	<b>F85-594</b> (10.10.4)
ΥΛ. / MATERIALE	PVC
ΤΙΜΗ / PRICE	<b>0,70 €/pc</b>

# Υαλοπίνακες / Glass

Λεπτομέρεια τζαμιού / Glass detail

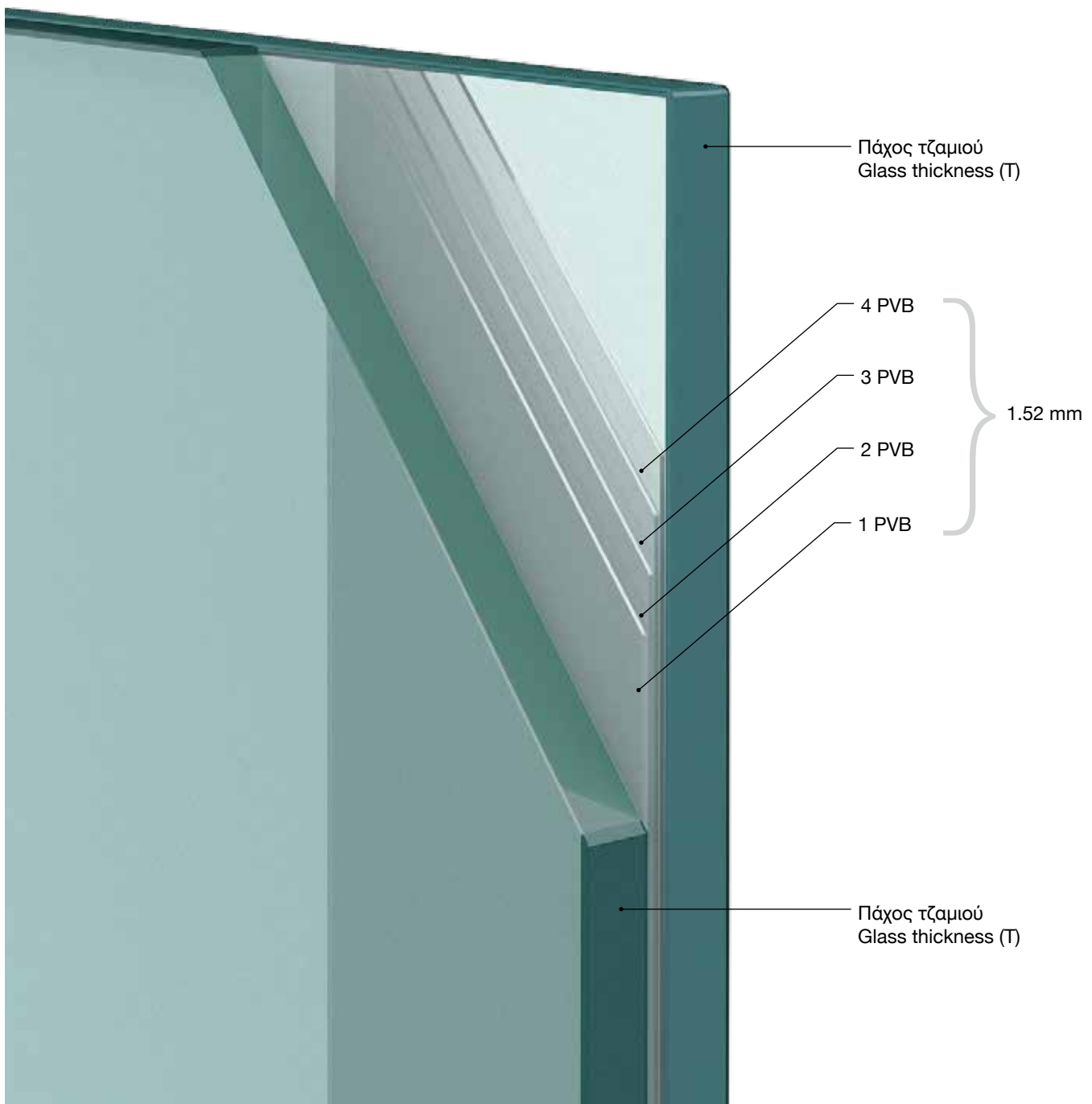

# Υαλοπίνακες / Glass

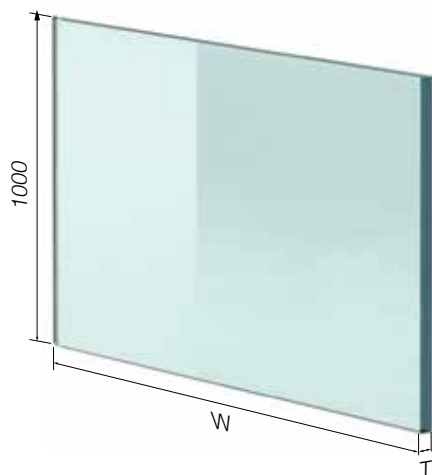

Έτοιμοι υαλοπίνακες ύψους 1000mm  
Glass dimensions 1000 mm

Ύψος / Height: 1000 mm		T: 8.8.4 (17.52)	
Κωδ. / Code	W	Βάρος / Weight Kg	Τιμή / Price €/m <sup>2</sup>
F85-GL16U10	600	24	230,00
F85-GL16U11	800	32	230,00
F85-GL16U07	900	36	230,00
F85-GL16U08	1000	40	230,00
F85-GL16U12	1100	44	230,00
F85-GL16U09	1200	48	230,00
F85-GL16U13	1300	52	230,00

ΑΜΕΣΑ ΔΙΑΘΕΣΙΜΑ / IMMEDIATELY AVAILABLE FROM STOCK!

Ύψος / Height: 1000 mm		T: 5.5.2 (10.76)	
Κωδ. / Code	W	Βάρος / Weight Kg	Τιμή / Price €/m <sup>2</sup>
F85-GL10U03	500	12.5	70,00
F85-GL10U04	600	15	70,00
F85-GL10U05	800	20	70,00
F85-GL10U01	900	22.5	70,00
F85-GL10U02	1000	25	70,00
F85-GL10U06	1100	27.5	70,00
F85-GL10U07	1200	30	70,00

ΑΜΕΣΑ ΔΙΑΘΕΣΙΜΑ / IMMEDIATELY AVAILABLE FROM STOCK!

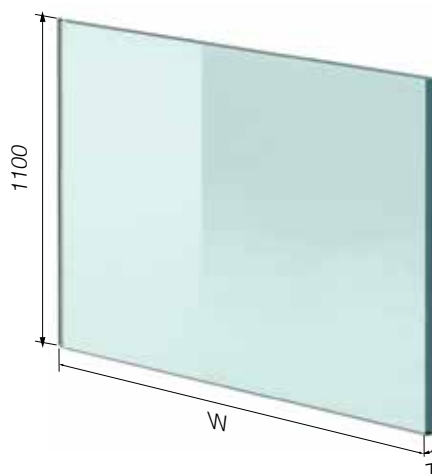

Έτοιμοι υαλοπίνακες ύψους 1000mm  
Glass dimensions 1000 mm

Ύψος / Height: 1100 mm		T: 8.8.4 (17.52)	
Κωδ. / Code	W	Βάρος / Weight Kg	Τιμή / Price €/m <sup>2</sup>
F85-GL16U14	600	26.4	230,00
F85-GL16U15	800	35.2	230,00
F85-GL16U16	900	39.6	230,00
F85-GL16U12	1000	44	230,00
F85-GL16U17	1100	48.4	230,00
F85-GL16U18	1200	52.8	230,00

ΑΜΕΣΑ ΔΙΑΘΕΣΙΜΑ / IMMEDIATELY AVAILABLE FROM STOCK!

ΔΙΑΤΙΘΕΝΤΑΙ ΕΙΔΙΚΕΣ ΣΥΣΚΕΥΑΣΙΕΣ (ΞΥΛΟΠΑΛΛΕΤΕΣ) ΜΕ ΧΡΕΩΣΗ 20 €/ΠΑΛ. (ΜΕΓΙΣΤΟ ΒΑΡΟΣ 400KG)  
ΟΙ ΔΙΑΣΤΑΣΕΙΣ ΠΙΘΑΝΟΝ ΝΑ ΔΙΑΦΕΡΟΥΝ ΣΕ ΜΜ ΛΟΓΩ ΠΕΡΙΜΕΤΡΙΚΗΣ ΛΕΙΑΝΣΗΣ

SPECIAL PACKAGING (GOODEN PALLET) CHARGED 20 €/PAL (MAX WEIGHT 400KG)  
DIMENSIONS MAY VARY DUE TO PERIMETRIC GRINDING.



# Εξαρτήματα στήριξης υαλοπίνακα Accessories glass supporting system

## Προφίλ κουραστής / Handrail profiles



ΣΤΡΟΓΓΥΛΗ ΚΟΥΡΑΣΤΗ  
ROUND HANDRAIL

ΚΩΔ. / CODE	<b>F50-200</b>
ΒΑΡΟΣ / WEIGHT	814 gr/m
ΜΗΚΟΣ / LENGTH	6 m
ΤΙΜΗ / PRICE	<b>7,40 €/Kg</b>



ΣΤΡΟΓΓΥΛΗ ΚΟΥΡΑΣΤΗ Ø50  
ROUND HANDRAIL Ø50

ΚΩΔ. / CODE	<b>F85-202</b>
ΒΑΡΟΣ / WEIGHT	721 gr/m
ΜΗΚΟΣ / LENGTH	6 m
ΤΙΜΗ / PRICE	<b>7,70 €/Kg</b>



ΟΒΑΛ ΚΟΥΡΑΣΤΗ  
OVAL SHAPED HANDRAIL

ΚΩΔ. / CODE	<b>F85-203</b>
ΒΑΡΟΣ / WEIGHT	1096 gr/m
ΜΗΚΟΣ / LENGTH	6 m
ΤΙΜΗ / PRICE	<b>7,70 €/Kg</b>



ΣΤΡΟΓΓΥΛΗ ΚΟΥΡΑΣΤΗ Ø50  
ROUND HANDRAIL Ø50

ΚΩΔ. / CODE	<b>F85-204</b>
ΒΑΡΟΣ / WEIGHT	973 gr/m
ΜΗΚΟΣ / LENGTH	6 m
ΤΙΜΗ / PRICE	<b>7,70 €/Kg</b>



ΚΟΥΡΑΣΤΗ 30X80  
HANDRAIL 30X80

ΚΩΔ. / CODE	<b>F50-201</b>
ΒΑΡΟΣ / WEIGHT	1350 gr/m
ΜΗΚΟΣ / LENGTH	6 m
ΤΙΜΗ / PRICE	<b>7,40 €/Kg</b>

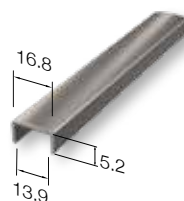

ΚΟΥΡΑΣΤΗ ΓΙΑ ΥΑΛΟΠΙΝΑΚΑ 6.6.2/6.6.4  
HANDRAIL 6.6.2/6.6.4

ΚΩΔ. / CODE	<b>F85-313</b>
ΒΑΡΟΣ / WEIGHT	99 gr/m
ΜΗΚΟΣ / LENGTH	6 m
ΤΙΜΗ / PRICE	<b>7,70 €/Kg</b>



ΚΟΥΡΑΣΤΗ ΓΙΑ ΥΑΛΟΠΙΝΑΚΑ 8.8.4  
HANDRAIL 8.8.4

ΚΩΔ. / CODE	<b>F85-317</b>
ΒΑΡΟΣ / WEIGHT	198 gr/m
ΜΗΚΟΣ / LENGTH	6 m
ΤΙΜΗ / PRICE	<b>7,70 €/Kg</b>



ΚΟΥΡΑΣΤΗ ΓΙΑ ΥΑΛΟΠΙΝΑΚΑ 10.10.4  
HANDRAIL 10.10.4

ΚΩΔ. / CODE	<b>F85-321</b>
ΒΑΡΟΣ / WEIGHT	219 gr/m
ΜΗΚΟΣ / LENGTH	6 m
ΤΙΜΗ / PRICE	<b>7,70 €/Kg</b>



ΤΑΠΑ ΚΟΥΡΑΣΤΗΣ F85-203  
HANDRAIL END CAP F85-203

ΚΩΔ. / CODE	<b>F85-403</b>
ΦΥΣΙΚΗ ΑΝΟΔΙΩΣΗ ANODIZE NATURAL	<b>4,50 €/pc</b>
ΓΥΑΛΙΣΤΕΡΗ ΑΝΟΔΙΩΣΗ F50 ANODIZE GLOSS F50	<b>4,60 €/pc</b>
ΛΕΥΚΟ / ΜΑΥΡΟ WHITE / BLACK	<b>4,50 €/pc</b>



ΤΑΠΑ ΚΟΥΡΑΣΤΗΣ F85-202/204  
HANDRAIL END CAP F85-202/204

ΚΩΔ. / CODE	<b>F85-404</b>
ΦΥΣΙΚΗ ΑΝΟΔΙΩΣΗ ANODIZE NATURAL	<b>2,60 €/pc</b>
ΓΥΑΛΙΣΤΕΡΗ ΑΝΟΔΙΩΣΗ F50 ANODIZE GLOSS F50	<b>2,70 €/pc</b>
ΛΕΥΚΟ / ΜΑΥΡΟ WHITE / BLACK	<b>2,30 €/pc</b>



ΤΑΠΑ ΚΟΥΡΑΣΤΗΣ F50-200  
HANDRAIL CAP F50-200

ΚΩΔ. / CODE	<b>4434</b>
ΦΥΣΙΚΗ ΑΝΟΔΙΩΣΗ ANODIZE NATURAL	<b>1,40 €/pc</b>
ΓΥΑΛΙΣΤΕΡΗ ΑΝΟΔΙΩΣΗ F50 ANODIZE GLOSS F50	<b>1,45 €/pc</b>
ΛΕΥΚΟ / ΜΑΥΡΟ WHITE / BLACK	<b>1,30 €/pc</b>



ΤΑΠΑ ΚΟΥΡΑΣΤΗΣ F50-200 ΕΠΙΠΕΔΗ  
HANDRAIL CAP F50-200 FLAT

ΚΩΔ. / CODE	<b>4453</b>
ΦΥΣΙΚΗ ΑΝΟΔΙΩΣΗ ANODIZE NATURAL	<b>2,20 €/pc</b>
ΓΥΑΛΙΣΤΕΡΗ ΑΝΟΔΙΩΣΗ F50 ANODIZE GLOSS F50	<b>2,25 €/pc</b>
ΛΕΥΚΟ / ΜΑΥΡΟ WHITE / BLACK	<b>2,20 €/pc</b>



ΤΑΠΑ ΚΟΥΡΑΣΤΗΣ F50-201  
HANDRAIL CAP F50-201

ΚΩΔ. / CODE	<b>4447</b>
ΓΥΑΛΙΣΤΕΡΗ ΑΝΟΔΙΩΣΗ F50 ANODIZE GLOSS F50	<b>2,70 €/pc</b>
ΛΕΥΚΟ / ΜΑΥΡΟ WHITE / BLACK	<b>2,65 €/pc</b>

### ΤΙΜΟΚΑΤΑΛΟΓΟΣ ΧΡΩΜΑΤΩΝ COLORS PRICELIST

ΚΑΤΗΓΟΡΙΑ / CATEGORY A	0,60 €
ΚΑΤΗΓΟΡΙΑ / CATEGORY A2	0,75 €
ΚΑΤΗΓΟΡΙΑ / CATEGORY SMART	0,85 €
ΚΑΤΗΓΟΡΙΑ / CATEGORY B	0,90 €
ΚΑΤΗΓΟΡΙΑ / CATEGORY C	1,00 €
ΚΑΤΗΓΟΡΙΑ / CATEGORY D	1,10 €
ΚΑΤΗΓΟΡΙΑ / CATEGORY E	1,40 €
ΚΑΤΗΓΟΡΙΑ / CATEGORY F	1,60 €
ΣΟΜΠΑΙΧΡΩΜΙΑ / WOOD COLORS	3,05 €
ΑΝΟΔΙΩΣΗ ΓΥΑΛΙΣΤΕΡΗ A-432 ΓΙΑ ΠΡΟΦΙΛ ΚΑΓΚΕΛΟΥ F-50 ANODISE A-432 FOR RAILING PROFILE F-50	1,90 €
ΑΝΟΔΙΩΣΗ ΓΥΑΛΙΣΤΕΡΗ A-432 ΓΙΑ ΠΡΟΦΙΛ ΚΑΓΚΕΛΟΥ CRYSTAL LINE ANODISE A-432 FOR RAILING PROFILE CRYSTAL LINE	1,90 €

# Εξαρτήματα στήριξης υαλοπίνακα Accessories glass supporting system

Εξαρτήματα σύνδεσης κουπαστών, αρμοκάλυπτρα / Handrail connection accessories, seam covers



ΣΥΝΔΕΣΜΟΣ ΚΟΥΠΑΣΤΗΣ  
F85-202/204 ΕΥΘΕΙΑ  
HANDRAIL CONNECTOR  
F85-202/204 STRAIGHT

ΚΩΔ. / CODE	<b>4251</b>
ΦΥΣΙΚΗ ΑΝΟΔΙΩΣΗ ANODIZE NATURAL	<b>2,90 €/pc</b>
ΓΥΑΛΙΣΤΕΡΗ ΑΝΟΔΙΩΣΗ F50 ANODIZE GLOSS F50	<b>2,80 €/pc</b>



ΣΥΝΔΕΣΜΟΣ ΚΟΥΠΑΣΤΗΣ  
F85-202/204 ΓΩΝΙΑ  
HANDRAIL CONNECTOR  
F85-202/204 ANGLED

ΚΩΔ. / CODE	<b>4253</b>
ΦΥΣΙΚΗ ΑΝΟΔΙΩΣΗ ANODIZE NATURAL	<b>11,00 €/pc</b>
ΓΥΑΛΙΣΤΕΡΗ ΑΝΟΔΙΩΣΗ F50 ANODIZE GLOSS F50	<b>11,00 €/pc</b>



ΑΡΜΟΚΑΛΥΠΤΡΟ ΚΟΥΠΑΣΤΗΣ F85-203  
HANDRAIL SEAM COVER F85-203

ΚΩΔ. / CODE	<b>F85-402</b>
ΦΥΣΙΚΗ ΑΝΟΔΙΩΣΗ ANODIZE NATURAL	<b>4,50 €/pc</b>
ΓΥΑΛΙΣΤΕΡΗ ΑΝΟΔΙΩΣΗ F50 ANODIZE GLOSS F50	<b>4,50 €/pc</b>



ΑΡΜΟΚΑΛΥΠΤΡΟ ΚΟΥΠΑΣΤΗΣ  
Ø50 ΜΕ ΚΑΠΑΚΙ  
HANDRAIL SEAM COVER Ø50 WITH COVER

ΚΩΔ. / CODE	<b>4509Z</b>
ΦΥΣΙΚΗ ΑΝΟΔΙΩΣΗ ANODIZE NATURAL	<b>5,10 €/pc</b>
ΓΥΑΛΙΣΤΕΡΗ ΑΝΟΔΙΩΣΗ F50 ANODIZE GLOSS F50	<b>6,20 €/pc</b>

## Στήριγματα κουπαστών / Handrail supports



ΕΠΙΤΟΙΧΙΟ ΣΤΗΡΙΓΜΑ ΚΟΥΠΑΣΤΗΣ F85-202  
WALL SUPPORT FOR HANDRAIL F85-202

ΚΩΔ. / CODE	<b>F85-452</b>
ΦΥΣΙΚΗ ΑΝΟΔΙΩΣΗ ANODIZE NATURAL	<b>14,60 €/pc</b>
ΓΥΑΛΙΣΤΕΡΗ ΑΝΟΔΙΩΣΗ F50 ANODIZE GLOSS F50	<b>14,60 €/pc</b>



ΕΠΙΤΟΙΧΙΟ ΣΤΗΡΙΓΜΑ ΚΟΥΠΑΣΤΗΣ F50-200  
WALL SUPPORT FOR HANDRAIL F50-200

ΚΩΔ. / CODE	<b>4134</b>
ΦΥΣΙΚΗ ΑΝΟΔΙΩΣΗ ANODIZE NATURAL	<b>3,30 €/pc</b>
ΓΥΑΛΙΣΤΕΡΗ ΑΝΟΔΙΩΣΗ F50 ANODIZE GLOSS F50	<b>2,70 €/pc</b>



ΕΠΙΤΟΙΧΙΟ ΣΤΗΡΙΓΜΑ ΚΟΥΠΑΣΤΗΣ F50-200  
WALL SUPPORT FOR HANDRAIL F50-200

ΚΩΔ. / CODE	<b>4140</b>
ΦΥΣΙΚΗ ΑΝΟΔΙΩΣΗ ANODIZE NATURAL	<b>6,45 €/pc</b>
ΓΥΑΛΙΣΤΕΡΗ ΑΝΟΔΙΩΣΗ F50 ANODIZE GLOSS F50	<b>6,40 €/pc</b>



ΕΠΙΤΟΙΧΙΟ ΣΤΗΡΙΓΜΑ ΚΟΥΠΑΣΤΗΣ F50-200  
WALL SUPPORT FOR HANDRAIL F50-200

ΚΩΔ. / CODE	<b>4141</b>
ΦΥΣΙΚΗ ΑΝΟΔΙΩΣΗ ANODIZE NATURAL	<b>2,65 €/pc</b>
ΓΥΑΛΙΣΤΕΡΗ ΑΝΟΔΙΩΣΗ F50 ANODIZE GLOSS F50	<b>1,90 €/pc</b>



ΕΠΙΤΟΙΧΙΟ ΣΤΗΡΙΓΜΑ ΚΟΥΠΑΣΤΗΣ F50-200  
WALL SUPPORT FOR HANDRAIL F50-200

ΚΩΔ. / CODE	<b>4165</b>
ΦΥΣΙΚΗ ΑΝΟΔΙΩΣΗ ANODIZE NATURAL	<b>9,80 €/pc</b>
ΓΥΑΛΙΣΤΕΡΗ ΑΝΟΔΙΩΣΗ F50 ANODIZE GLOSS F50	<b>9,50 €/pc</b>



ΣΤΗΡΙΓΜΑ ΚΟΥΠΑΣΤΗΣ F50-200  
HANDRAIL SUPPORT F50-200

ΚΩΔ. / CODE	<b>F85-451</b>
ΦΥΣΙΚΗ ΑΝΟΔΙΩΣΗ ANODIZE NATURAL	<b>12,40 €/pc</b>
ΓΥΑΛΙΣΤΕΡΗ ΑΝΟΔΙΩΣΗ F50 ANODIZE GLOSS F50	<b>12,40 €/pc</b>



ΣΤΗΡΙΓΜΑ ΚΟΥΠΑΣΤΗΣ F50-200  
HANDRAIL SUPPORT F50-200

ΚΩΔ. / CODE	<b>4148-200</b>
ΤΙΜΗ / PRICE	<b>48,00 €/pc</b>



ΣΤΗΡΙΓΜΑ ΚΟΥΠΑΣΤΗΣ F50-200  
HANDRAIL SUPPORT F50-200

ΚΩΔ. / CODE	<b>4148-201</b>
ΤΙΜΗ / PRICE	<b>48,50 €/pc</b>



ΣΤΗΡΙΓΜΑ ΚΟΥΠΑΣΤΗΣ F50-201  
HANDRAIL SUPPORT F50-201

ΚΩΔ. / CODE	<b>F85-454</b>
ΓΥΑΛΙΣΤΕΡΗ ΑΝΟΔΙΩΣΗ F50 ANODIZE GLOSS F50	<b>16,10 €/pc</b>

# Εξαρτήματα στήριξης υαλοπίνακα Accessories glass supporting system

## Λάστιχα κουραστής / Handrail gaskets



ΛΑΣΤΙΧΟ "Π" / "U" SHAPED GASKET

ΚΩΔ. / CODE	<b>F85-406</b> (8.8.4)
ΥΛ. / MATERIALE	EPDM
ΤΙΜΗ / PRICE	<b>2,47 €/m</b>

ΓΙΑ ΥΑΛΟΠΙΝΑΚΑ / FOR GLASS 8 MM+4PVB+ 8 MM



ΛΑΣΤΙΧΟ "Π" / "U" SHAPED GASKET

ΚΩΔ. / CODE	<b>F85-407</b> (10.10.4)
ΥΛ. / MATERIALE	EPDM
ΤΙΜΗ / PRICE	<b>2,28 €/m</b>

ΓΙΑ ΥΑΛΟΠΙΝΑΚΑ / FOR GLASS 10 MM+4PVB+ 10 MM



ΛΑΣΤΙΧΟ ΣΦΗΝΑ / SLUG GASKET

ΚΩΔ. / CODE	<b>EA410-420M</b>
ΥΛ. / MATERIALE	EPDM
ΤΙΜΗ / PRICE	<b>0,36 €/m</b>

## Διάφορα / Miscellaneous

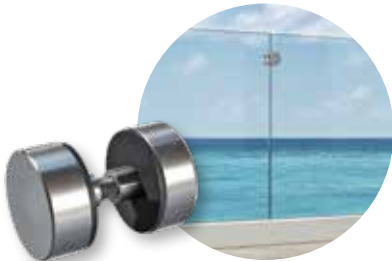

ΡΟΖΕΤΑ ΕΥΘΥΓΡΑΜΜΙΣΗΣ ΥΑΛΟΠΙΝΑΚΩΝ  
GLASS ALIGNMENT ROSETTE

ΚΩΔ. / CODE	<b>F85-D130</b> (8.8.4) (10.10.4)
ΥΛ. / MATERIAL	Inox 316
ΤΙΜΗ / PRICE	<b>17,40 €/pc</b>



ΕΞΟΛΚΕΑΣ ΚΑΠΑΚΙΟΥ ΤΥΠΟΥ Α  
TYPE A COVER EXTRACTOR

ΚΩΔ. / CODE	<b>F85-E011</b>
ΤΙΜΗ / PRICE	<b>1,40 €/pc</b>



ΟΥΔΕΤΕΡΗ ΣΙΛΙΚΟΝΗ  
NEUTRAL SILICON

ΚΩΔ. / CODE	<b>UA210.02BLX</b>
ΤΙΜΗ / PRICE	<b>3,64 €/pc</b>

## Βίδες στερέωσης / Fixing screw



ΒΙΔΑ ΑΛΛΕΝ M10X70 INOX  
INOX ALLEN SCREW M10X70

ΚΩΔ. / CODE	<b>EB912-1070</b>
ΤΙΜΗ / PRICE	<b>0,63 €/pc</b>



ΒΙΔΑ HEX M10X80 INOX  
INOX HEX SCREW M10X80

ΚΩΔ. / CODE	<b>EB933-1080</b>
ΤΙΜΗ / PRICE	<b>0,34 €/pc</b>



ΕΚΤΟΝΟΥΜΕΝΟ ΜΕΤΑΛ. ΟΥΠΑ  
EXPANSION PLUG

ΚΩΔ. / CODE	<b>EB01M-1060</b>
ΤΙΜΗ / PRICE	<b>1,37 €/pc</b>



ΤΣΙΜΕΝΟΒΙΔΑ TORX 7.5X112  
CONCRETE TORX 7.5X112

ΚΩΔ. / CODE	<b>EBM-75112G</b>
ΤΙΜΗ / PRICE	<b>0,12 €/pc</b>



ΜΠΕΤΟΒΙΔΑ Ø12-110  
CONCRETE SCREW Ø12-110

ΚΩΔ. / CODE	<b>EBM12-110</b>
ΤΙΜΗ / PRICE	<b>2,13 €/pc</b>



ΤΣΙΜΕΝΟΒΙΔΑ ΦΡΕΖΑΤΗ 10X120 ΑΛΛΕΝ  
ALLEN TORX CONCRETE SCREW 10X120

ΚΩΔ. / CODE	<b>EBM-10120G/2</b>
ΤΙΜΗ / PRICE	<b>1,52 €/pc</b>



ΒΙΔΑ DIN 7991 M10X70 INOX  
SCREW DIN 7991 M10X70 INOX

ΚΩΔ. / CODE	<b>D7991-00231</b>
ΤΙΜΗ / PRICE	<b>0,44 €/pc</b>



320 11 Inofita Viotia, Greece

T. +30 22620 47000

F. +30 22620 47090

[www.aluminco.com](http://www.aluminco.com)

[info@aluminco.com](mailto:info@aluminco.com)