

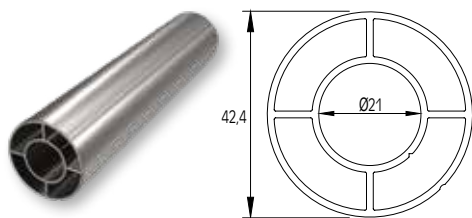

F50
RAILING SYSTEM

Τιμοκατάλογος / Pricelist





ΚΟΛΩΝΑ ΣΤΗΡΙΞΗΣ Ø42
SUPPORT COLUMN Ø42

ΚΩΔ. / CODE	F50-100
ΒΑΡΟΣ / WEIGHT	1025 gr/m
ΤΙΜΗ / PRICE	7,00 €/Kg



ΚΟΛΩΝΑ ΣΤΗΡΙΞΗΣ Ø50
SUPPORT COLUMN Ø50

ΚΩΔ. / CODE	F50-101
ΒΑΡΟΣ / WEIGHT	1915 gr/m
ΤΙΜΗ / PRICE	7,00 €/Kg

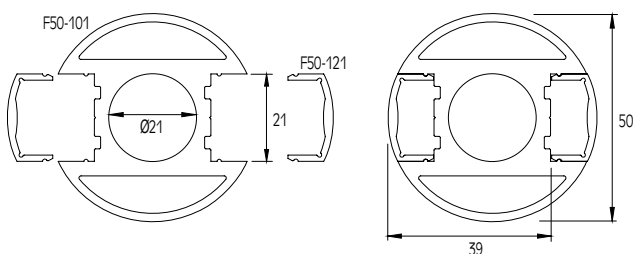

ΚΑΠΑΚΙ ΚΟΛΩΝΑΣ F50-101
COVER FOR F50-101 COLUMN

ΚΩΔ. / CODE	F50-121
ΒΑΡΟΣ / WEIGHT	152 gr/m
ΤΙΜΗ / PRICE	7,00 €/Kg



ΚΟΛΩΝΑ ΣΤΗΡΙΞΗΣ 40x40
SUPPORT COLUMN 40x40

ΚΩΔ. / CODE	F50-102
ΒΑΡΟΣ / WEIGHT	1153 gr/m
ΤΙΜΗ / PRICE	7,00 €/Kg

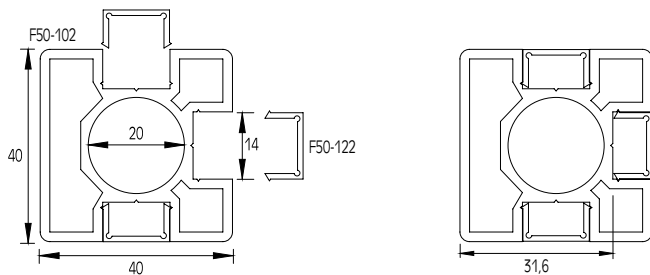

ΚΑΠΑΚΙ ΚΟΛΩΝΑΣ F50-102
COVER FOR F50-102 COLUMN

ΚΩΔ. / CODE	F50-122
ΒΑΡΟΣ / WEIGHT	86 gr/m
ΤΙΜΗ / PRICE	7,00 €/Kg



ΚΟΛΩΝΑ ΣΤΗΡΙΞΗΣ Ø42
SUPPORT COLUMN Ø42

ΚΩΔ. / CODE	F50-103
ΒΑΡΟΣ / WEIGHT	980 gr/m
ΤΙΜΗ / PRICE	7,00 €/Kg

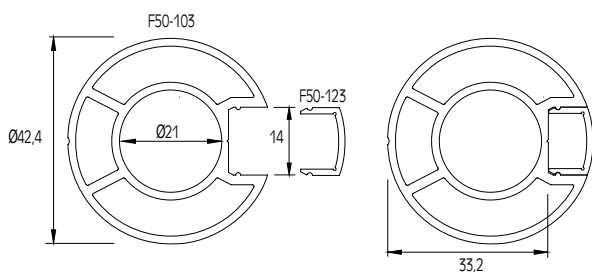

ΚΑΠΑΚΙ ΚΟΛΩΝΑΣ F50-103
COVER FOR F50-103 COLUMN

ΚΩΔ. / CODE	F50-123
ΒΑΡΟΣ / WEIGHT	90 gr/m
ΤΙΜΗ / PRICE	7,00 €/Kg

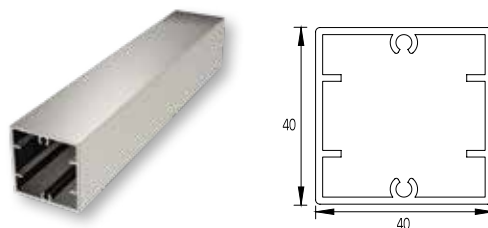

ΚΟΛΩΝΑ ΣΤΗΡΙΞΗΣ 40x40
SUPPORT COLUMN 40x40

ΚΩΔ. / CODE	F50-106
ΒΑΡΟΣ / WEIGHT	794 gr/m
ΤΙΜΗ / PRICE	7,00 €/Kg

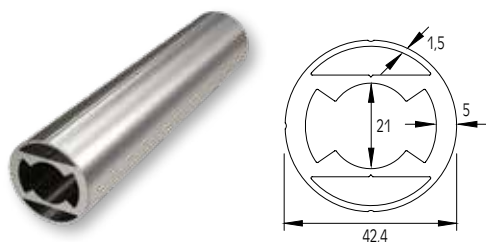

ΚΟΛΩΝΑ ΣΤΗΡΙΞΗΣ Ø42 ΕΝΙΣΧΥΜΕΝΗ
SUPPORT COLUMN Ø42 (HEAVY-DUTY)

ΚΩΔ. / CODE	F50-107
ΒΑΡΟΣ / WEIGHT	1647 gr/m
ΤΙΜΗ / PRICE	7,00 €/Kg

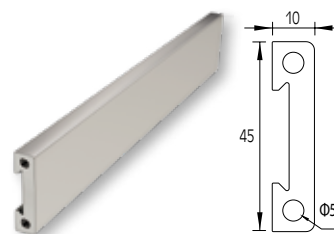

ΠΡΟΦΙΛ ΚΟΛΩΝΑΣ BLADE
BLADE COLUMN

ΚΩΔ. / CODE	F50-108
ΒΑΡΟΣ / WEIGHT	851 gr/m
ΤΙΜΗ / PRICE	7,00 €/Kg

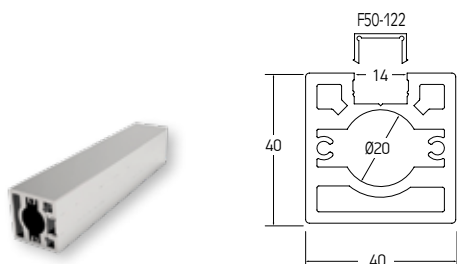

ΚΟΛΩΝΑ ΣΤΗΡΙΞΗΣ 40x40
SUPPORT COLUMN 40x40

ΚΩΔ. / CODE	F50-109
ΒΑΡΟΣ / WEIGHT	1968 gr/m
ΤΙΜΗ / PRICE	7,00 €/Kg

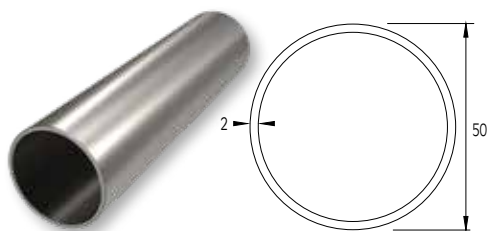

ΚΟΥΠΑΣΤΗ Ø50
HANDRAIL Ø50

ΚΩΔ. / CODE	F50-200
ΒΑΡΟΣ / WEIGHT	815 gr/m
ΤΙΜΗ / PRICE	7,00 €/Kg

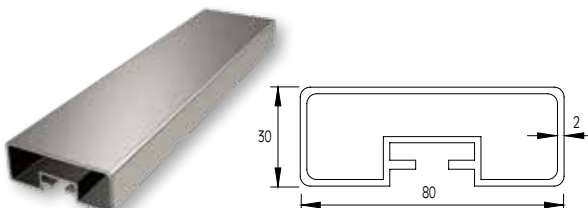

ΚΟΥΠΑΣΤΗ 30x80
HANDRAIL 30x80

ΚΩΔ. / CODE	F50-201
ΒΑΡΟΣ / WEIGHT	1350 gr/m
ΤΙΜΗ / PRICE	7,00 €/Kg



ΔΙΑΙΡΟΥΜΕΝΗ ΚΟΥΠΑΣΤΗ 30x80
DIVIDABLE HANDRAIL 30x80

ΚΩΔ. / CODE	F50-203
ΒΑΡΟΣ / WEIGHT	740 gr/m
ΤΙΜΗ / PRICE	7,00 €/Kg

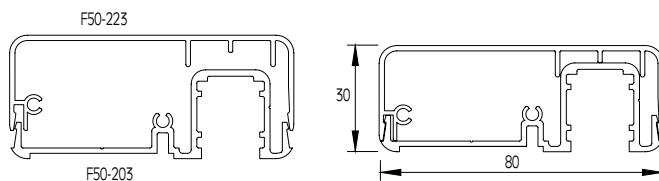

ΚΑΠΑΚΙ ΔΙΑΙΡΟΥΜΕΝΗΣ ΚΟΥΠΑΣΤΗΣ F50-203
COVER FOR DIVIDABLE HANDRAIL F50-203

ΚΩΔ. / CODE	F50-223
ΒΑΡΟΣ / WEIGHT	610 gr/m
ΤΙΜΗ / PRICE	7,00 €/Kg

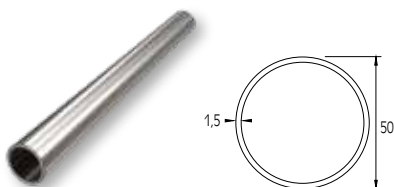

ΚΟΥΠΑΣΤΗ Ø50
HANDRAIL Ø50

ΚΩΔ. / CODE	F50-205
ΒΑΡΟΣ / WEIGHT	617 gr/m
ΤΙΜΗ / PRICE	7,00 €/Kg

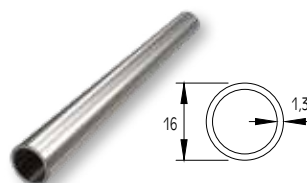

ΠΡΟΦΙΛ Ø16x1,3
PROFILE Ø16x1.3

ΚΩΔ. / CODE	F50-300
ΒΑΡΟΣ / WEIGHT	162 gr/m
ΤΙΜΗ / PRICE	7,00 €/Kg

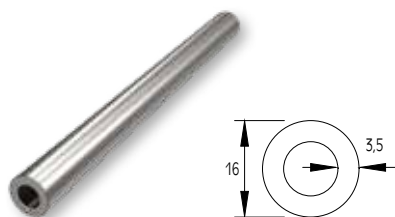

ΠΡΟΦΙΛ Ø16x3,5
PROFILE Ø16x3.5

ΚΩΔ. / CODE	F50-301
ΒΑΡΟΣ / WEIGHT	370 gr/m
ΤΙΜΗ / PRICE	7,00 €/Kg

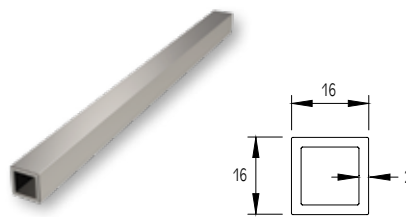

ΚΑΡΕ 16x16x2
SQUARE 16x16x2

ΚΩΔ. / CODE	F50-302
ΒΑΡΟΣ / WEIGHT	302 gr/m
ΤΙΜΗ / PRICE	7,00 €/Kg



ΠΡΟΦΙΛ Ø16 ΜΕ ΥΠΟΔΟΧΗ ΓΙΑ ΒΙΔΑ
PROFILE Ø16 WITH SCREW HOLE

ΚΩΔ. / CODE	F50-303
ΒΑΡΟΣ / WEIGHT	262 gr/m
ΤΙΜΗ / PRICE	7,00 €/Kg

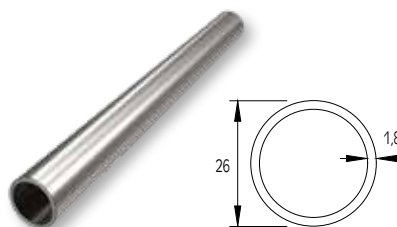

ΠΡΟΦΙΛ Ø26
PROFILE Ø26x1.8

ΚΩΔ. / CODE	F50-304
ΒΑΡΟΣ / WEIGHT	370 gr/m
ΤΙΜΗ / PRICE	7,00 €/Kg

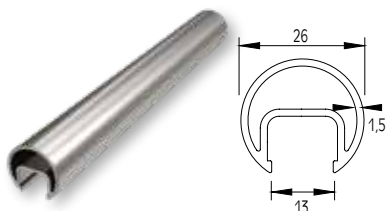

ΟΔΗΓΟΣ ΓΙΑ ΤΖΑΜΙ
GUIDE FOR GLASS

ΚΩΔ. / CODE	F50-305
ΒΑΡΟΣ / WEIGHT	394 gr/m
ΤΙΜΗ / PRICE	7,00 €/Kg

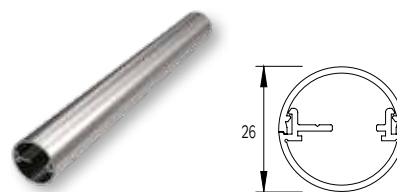

ΟΔΗΓΟΣ ΔΙΑΤΡΗΤΟΣ Ø26
PERFORATED GUIDE Ø26

ΚΩΔ. / CODE	F50-306
ΒΑΡΟΣ / WEIGHT	368 gr/m
ΤΙΜΗ / PRICE	7,00 €/Kg

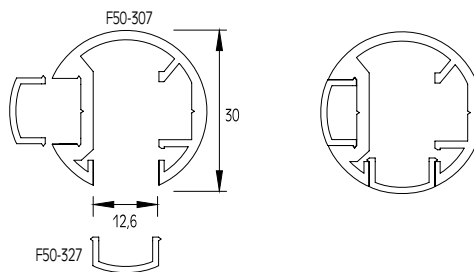

ΟΔΗΓΟΣ Ø30
GUIDE Ø30

ΚΩΔ. / CODE	F50-307
ΒΑΡΟΣ / WEIGHT	442 gr/m
ΤΙΜΗ / PRICE	7,00 €/Kg

ΚΑΠΑΚΙ ΟΔΗΓΟΥ Ø30
COVER FOR GUIDE Ø30

ΚΩΔ. / CODE	F50-327
ΒΑΡΟΣ / WEIGHT	68 gr/m
ΤΙΜΗ / PRICE	7,00 €/Kg

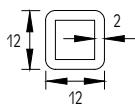

ΠΡΟΦΙΛ 12x12x2
PROFILE 12x12x2

ΚΩΔ. / CODE	F50-308
ΒΑΡΟΣ / WEIGHT	215 gr/m
ΤΙΜΗ / PRICE	7,00 €/Kg

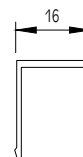

ΚΑΠΑΚΙ ΟΔΗΓΟΥ F50-319 & ΚΟΥΠΑΣΤΗΣ F50-203
COVER FOR F50-319 GUIDE AND F50-203 HANDRAIL

ΚΩΔ. / CODE	F50-311
ΒΑΡΟΣ / WEIGHT	176 gr/m
ΤΙΜΗ / PRICE	7,00 €/Kg

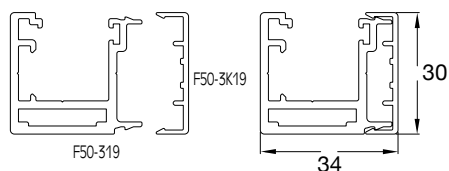

ΟΔΗΓΟΣ ΤΖΑΜΙΟΥ 10-12mm
GUIDE FOR GLASS 10-12mm

ΚΩΔ. / CODE	F50-319
ΒΑΡΟΣ / WEIGHT	687 gr/m
ΤΙΜΗ / PRICE	7,00 €/Kg

ΚΑΠΑΚΙ ΟΔΗΓΟΥ F50-319
COVER FOR F50-319 GUIDE

ΚΩΔ. / CODE	F50-3K19
ΒΑΡΟΣ / WEIGHT	160 gr/m
ΤΙΜΗ / PRICE	7,00 €/Kg

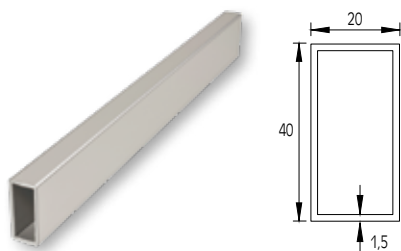

ΠΡΟΦΙΛ 40x20
PROFILE 40x20

ΚΩΔ. / CODE	59-009
ΒΑΡΟΣ / WEIGHT	462 gr/m

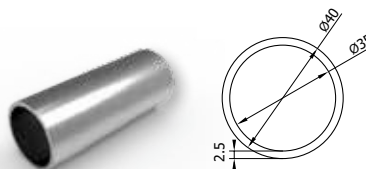

ΚΟΥΠΑΣΤΗ Ø40
HANDRAIL Ø40

ΚΩΔ. / CODE	F50-209
ΒΑΡΟΣ / WEIGHT	800 gr/m
ΤΙΜΗ / PRICE	7,00 €/Kg

ΤΙΜΟΚΑΤΑΛΟΓΟΣ ΧΡΩΜΑΤΩΝ
COLORS PRICELIST

Κατηγορία / CATEGORY A	0,60 €
Κατηγορία / CATEGORY A2	0,75 €
Κατηγορία / CATEGORY SMART	0,85 €
Κατηγορία / CATEGORY B	0,90 €
Κατηγορία / CATEGORY C	1,00 €
Κατηγορία / CATEGORY D	1,10 €
Κατηγορία / CATEGORY E	1,40 €
Κατηγορία / CATEGORY F	1,60 €
ΣΟΥΜΠΛΙΧΡΩΜΙΑ / WOOD COLORS	2,95 €
Ανοδισή Γυαλιστερή A-432 για προφίλ καγκέλου F-50 ANODISE A-432 FOR RAILING PROFILE F-50	1,90 €
Ανοδισή Γυαλιστερή A-432 για προφίλ καγκέλου Crystal Line ANODISE A-432 FOR RAILING PROFILE Crystal Line	1,90 €

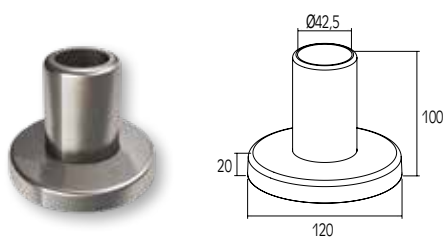

ΕΞΩΤΕΡΙΚΟ ΠΕΛΜΑ ΣΤΗΡΙΞΗΣ ΓΙΑ ΚΟΛΩΝΑ Ø42
EXTERNAL SUPPORT FOOT FOR Ø42 COLUMN

ΚΩΔ. / CODE	4112
ΤΙΜΗ / PRICE	12,75 €/pc

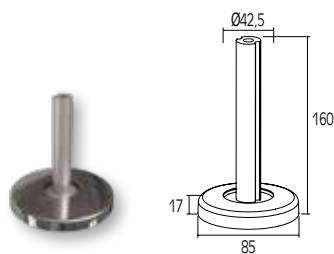

ΠΕΛΜΑ ΣΤΗΡΙΞΗΣ ΓΙΑ ΚΟΛΩΝΑ Ø42
SUPPORT FOOT FOR Ø42 COLUMN

ΚΩΔ. / CODE	4115
ΤΙΜΗ / PRICE	5,60 €/pc

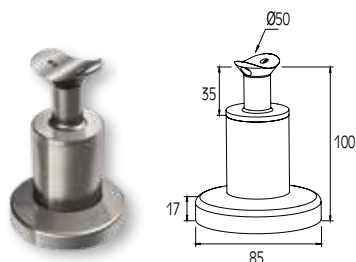

ΣΤΗΡΙΓΜΑ ΚΟΥΠΙΑΣΤΗΣ F50-200
SUPPORT FOR F50-200 HANDRAIL

ΚΩΔ. / CODE	4116
ΤΙΜΗ / PRICE	8,50 €/pc

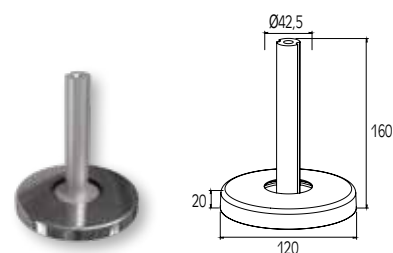

ΠΕΛΜΑ ΣΤΗΡΙΞΗΣ ΓΙΑ ΚΟΛΩΝΑ Ø42
SUPPORT FOOT FOR Ø42 COLUMN

ΚΩΔ. / CODE	4117
ΤΙΜΗ / PRICE	9,00 €/pc

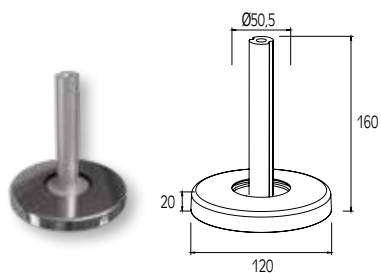

ΠΕΛΜΑ ΣΤΗΡΙΞΗΣ ΓΙΑ ΚΟΛΩΝΑ Ø50
SUPPORT FOOT FOR Ø50 COLUMN

ΚΩΔ. / CODE	4119
ΤΙΜΗ / PRICE	9,00 €/pc

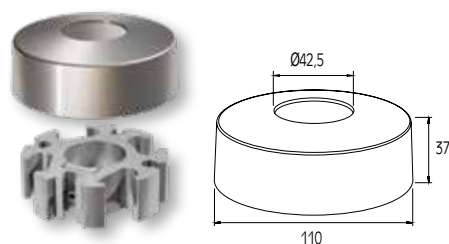

ΠΕΛΜΑ ΣΤΗΡΙΞΗΣ ΓΙΑ ΚΟΛΩΝΑ Ø42
SUPPORT FOOT FOR Ø42 COLUMN

ΚΩΔ. / CODE	4121
ΤΙΜΗ / PRICE	7,50 €/pc

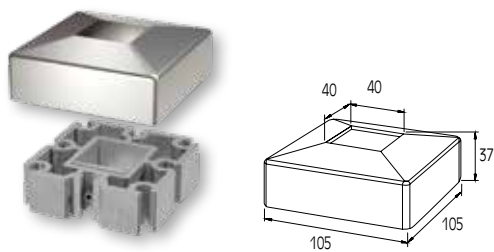

ΠΕΛΜΑ ΣΤΗΡΙΞΗΣ ΓΙΑ ΚΟΛΩΝΑ 40x40
SUPPORT FOOT FOR 40x40 COLUMN

ΚΩΔ. / CODE	4122
ΤΙΜΗ / PRICE	8,35 €/pc

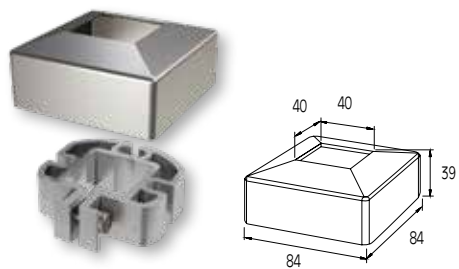

ΠΕΛΜΑ ΣΤΗΡΙΞΗΣ ΓΙΑ ΚΟΛΩΝΑ 40x40
SUPPORT FOOT FOR 40x40 COLUMN

ΚΩΔ. / CODE	4124
ΤΙΜΗ / PRICE	8,00 €/pc

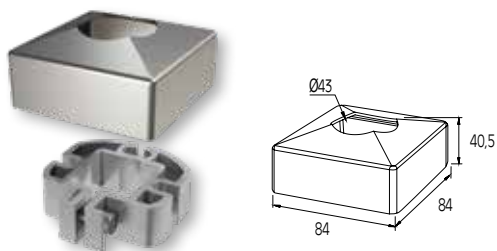

ΠΕΛΜΑ ΣΤΗΡΙΞΗΣ ΓΙΑ ΚΟΛΩΝΑ Ø42
SUPPORT FOOT FOR Ø42 COLUMN

ΚΩΔ. / CODE	4126
ΤΙΜΗ / PRICE	9,95 €/pc

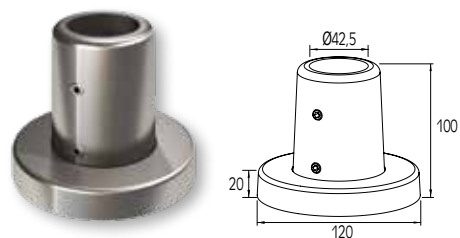

ΠΕΛΜΑ ΣΤΗΡΙΞΗΣ ΓΙΑ ΚΟΛΩΝΑ Ø42 ΒΑΡΕΩΣ ΤΥΠΟΥ
HEAVY DUTY SUPPORT FOOT FOR Ø42 COLUMN

ΚΩΔ. / CODE	4127
ΤΙΜΗ / PRICE	27,70 €/pc

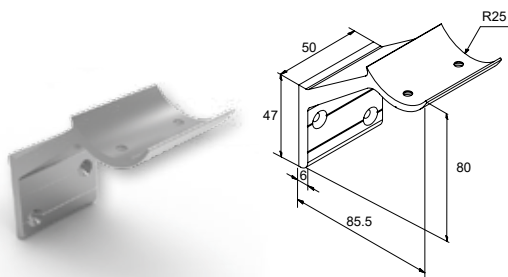

ΕΠΙΤΟΙΧΙΟ ΣΤΑΘΕΡΟ ΣΤΗΡΙΓΜΑ ΚΟΥΠΑΣΤΗΣ F50-200
FIXED WALL SUPPORT FOR F50-200 HANDRAIL

ΚΩΔ. / CODE	4134
ΤΙΜΗ / PRICE	3,40 €/pc

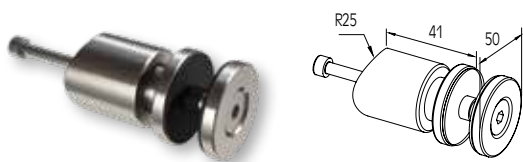

ΣΤΗΡΙΓΜΑ ΤΖΑΜΙΟΥ ΜΟΝΟ 8-10mm ΓΙΑ ΚΟΛΩΝΑ F50-101
SINGLE GLASS SUPPORT 8-10mm FOR F50-101 COLUMN

ΚΩΔ. / CODE	4137
ΤΙΜΗ / PRICE	10,20 €/pc

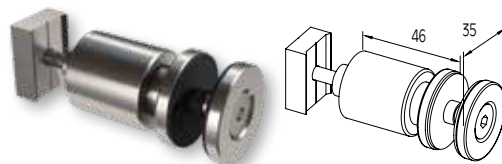

ΣΤΗΡΙΓΜΑ ΤΖΑΜΙΟΥ ΜΟΝΟ 8-10mm ΓΙΑ ΚΟΛΩΝΑ BLADE
SINGLE GLASS SUPPORT 8-10mm FOR BLADE COLUMN

ΚΩΔ. / CODE	4138
ΤΙΜΗ / PRICE	11,60 €/pc

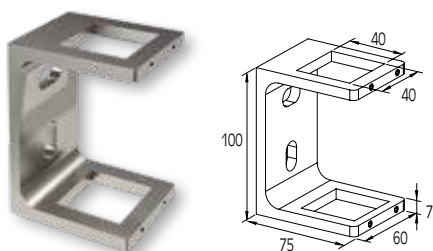

ΕΞΩΤΕΡΙΚΟ ΣΤΗΡΙΓΜΑ ΚΟΛΩΝΑΣ 40x40
EXTERNAL SUPPORT FOR 40x40 COLUMN

ΚΩΔ. / CODE	4139
ΤΙΜΗ / PRICE	13,10 €/pc

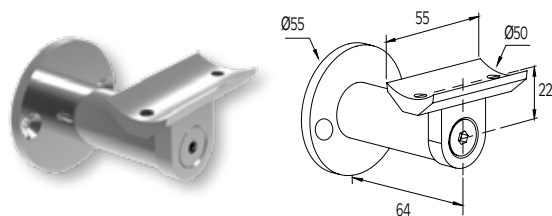

ΕΠΙΤΟΙΧΙΟ ΣΤΗΡΙΓΜΑ ΚΟΥΡΠΑΣΤΗΣ F50-200
WALL SUPPORT FOR F50-200 HANDRAIL

ΚΩΔ. / CODE	4140
ΤΙΜΗ / PRICE	6,55 €/pc

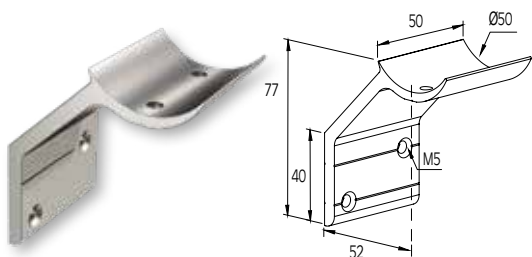

ΕΠΙΤΟΙΧΙΟ ΣΤΑΘΕΡΟ ΣΤΗΡΙΓΜΑ ΚΟΥΡΠΑΣΤΗΣ F50-200
FIXED WALL SUPPORT FOR F50-200 HANDRAIL

ΚΩΔ. / CODE	4141
ΤΙΜΗ / PRICE	2,75 €/pc

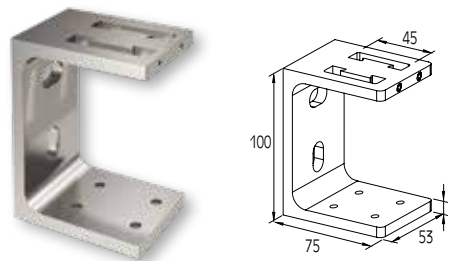

ΕΞΩΤΕΡΙΚΟ ΣΤΗΡΙΓΜΑ ΚΟΛΩΝΑΣ BLADE
EXTERNAL SUPPORT FOR BLADE COLUMN

ΚΩΔ. / CODE	4142
ΤΙΜΗ / PRICE	13,10 €/pc

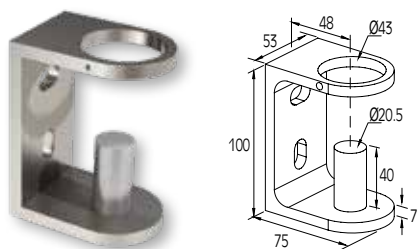

ΕΞΩΤΕΡΙΚΟ ΣΤΗΡΙΓΜΑ ΚΟΛΩΝΑΣ F50-100/103
EXTERNAL SUPPORT FOR F50-100/103 COLUMN

ΚΩΔ. / CODE **4143**
ΤΙΜΗ / PRICE **9,50 €/pc**

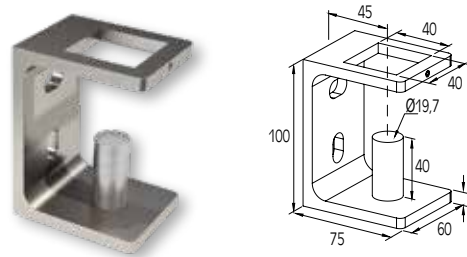

ΕΞΩΤΕΡΙΚΟ ΣΤΗΡΙΓΜΑ ΚΟΛΩΝΑΣ F50-102
EXTERNAL SUPPORT FOR F50-102 COLUMN

ΚΩΔ. / CODE **4144**
ΤΙΜΗ / PRICE **13,10 €/pc**

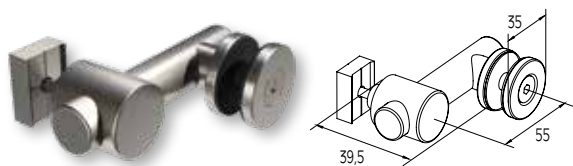

ΣΤΗΡΙΓΜΑ ΤΖΑΜΙΟΥ ΜΟΝΟ 8-10mm ΓΙΑ ΚΟΛΩΝΑ BLADE
SINGLE GLASS SUPPORT 8-10mm FOR BLADE COLUMN

ΚΩΔ. / CODE **4146**
ΤΙΜΗ / PRICE **14,60 €/pc**

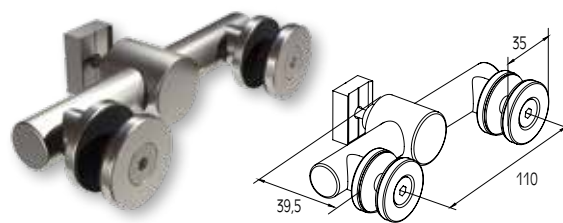

ΣΤΗΡΙΓΜΑ ΤΖΑΜΙΟΥ ΔΙΠΛΟ 8-10mm ΓΙΑ ΚΟΛΩΝΑ BLADE
SINGLE GLASS SUPPORT 8-10mm FOR BLADE COLUMN

ΚΩΔ. / CODE **4147**
ΤΙΜΗ / PRICE **20,20 €/pc**

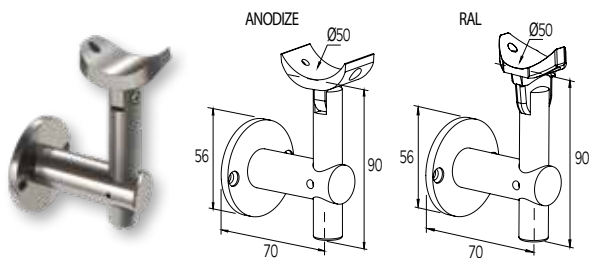

ΕΠΙΤΟΙΧΙΟ ΣΤΗΡΙΓΜΑ ΚΟΥΠΙΑΣΤΗΣ F50-200
WALL SUPPORT FOR F50-200 HANDRAIL WALL

ΚΩΔ. / CODE **4165**
ΤΙΜΗ / PRICE **9,90 €/pc**

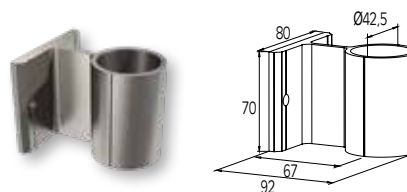

ΕΞΩΤΕΡΙΚΟ ΣΤΗΡΙΓΜΑ ΓΙΑ ΚΟΛΩΝΑ Ø42
EXTERNAL SUPPORT FOR Ø42 COLUMN

ΚΩΔ. / CODE **4166**
ΤΙΜΗ / PRICE **6,80 €/pc**

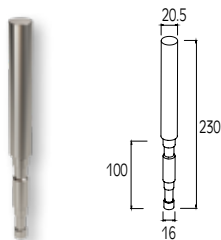

ΕΝΔΟΔΑΠΕΔΙΟ ΣΤΗΡΙΓΜΑ ΓΙΑ ΚΟΛΩΝΑ Ø42
INFLOOR SUPPORT FOR Ø42 COLUMN

ΚΩΔ. / CODE	4167
ΤΙΜΗ / PRICE	1,90 €/pc

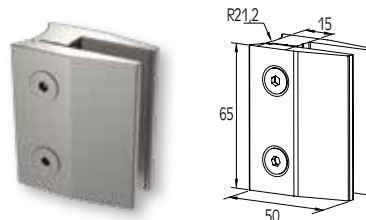

ΣΤΗΡΙΓΜΑ ΤΖΑΜΙΟΥ 8-10 mm
GLASS SUPPORT 8-10mm

ΚΩΔ. / CODE	4168
ΤΙΜΗ / PRICE	4,75 €/pc

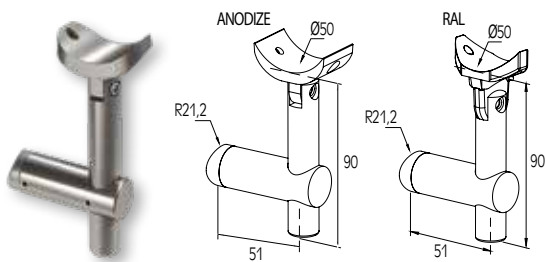

ΕΞΩΤΕΡΙΚΟ ΣΤΗΡΙΓΜΑ ΚΟΥΠΑΣΤΗΣ Ø50 ΜΕ ΚΟΛΩΝΑ Ø42
EXTERNAL SUPPORT FOR HANDRAIL Ø50 WITH COLUMN Ø42

ΚΩΔ. / CODE	4169
ΤΙΜΗ / PRICE	6,65 €/pc

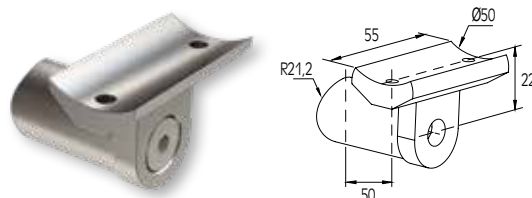

ΕΞΩΤΕΡΙΚΟ ΣΤΗΡΙΓΜΑ ΚΟΥΠΑΣΤΗΣ Ø50 ΜΕ ΚΟΛΩΝΑ Ø42
EXTERNAL SUPPORT FOR HANDRAIL Ø50 WITH COLUMN Ø42

ΚΩΔ. / CODE	4169B
ΤΙΜΗ / PRICE	5,10 €/pc

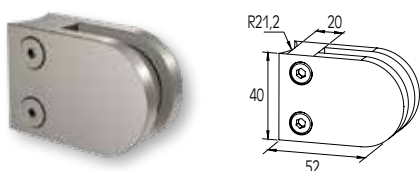

ΣΤΗΡΙΓΜΑ ΤΖΑΜΙΟΥ 6-8mm INOX
GLASS SUPPORT 6-8mm

ΚΩΔ. / CODE	4172
ΤΙΜΗ / PRICE INOX 304	5,90 €/pc
ΤΙΜΗ / PRICE INOX 316	12,85 €/pc

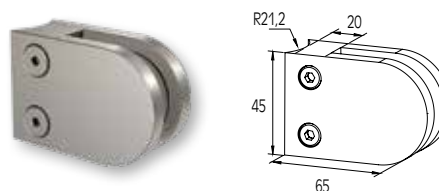

ΣΤΗΡΙΓΜΑ ΤΖΑΜΙΟΥ 8-10mm INOX
GLASS SUPPORT 8-10mm INOX

ΚΩΔ. / CODE	4173
ΤΙΜΗ / PRICE INOX 304	16,20 €/pc
ΤΙΜΗ / PRICE INOX 316	18,10 €/pc

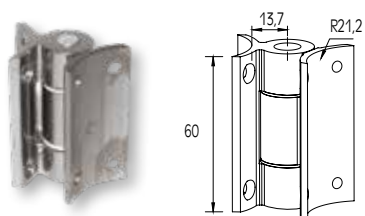

ΜΕΝΤΕΣΕΣ ΚΟΛΩΝΑΣ F50-100
HINGE FOR F50-100 COLUMN

ΚΩΔ. / CODE	4177
ΤΙΜΗ / PRICE	5,90 €/pc

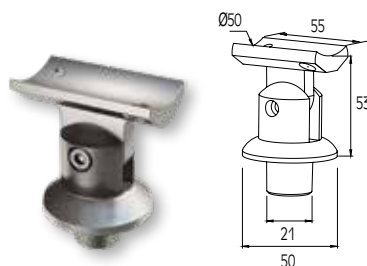

ΣΤΗΡΙΓΜΑ ΚΟΥΠΑΣΤΗΣ F50-200 ΜΕ ΚΟΛΩΝΑ F50-101
SUPPORT FOR HANDRAIL F50-200 WITH COLUMN F50-101

ΚΩΔ. / CODE	4179
ΤΙΜΗ / PRICE	7,95 €/pc

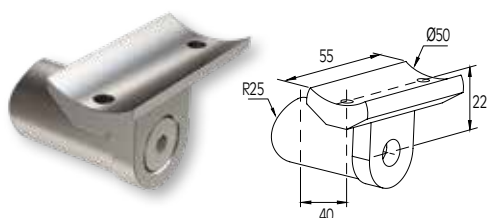

ΕΞΩΤΕΡΙΚΟ ΣΤΗΡΙΓΜΑ ΚΟΥΠΑΣΤΗΣ F50-200 ΜΕ ΚΟΛΩΝΑ F50-101
EXTERNAL SUPPORT FOR HANDRAIL F50-200 WITH COLUMN F50-101

ΚΩΔ. / CODE	4180
ΤΙΜΗ / PRICE	6,35 €/pc

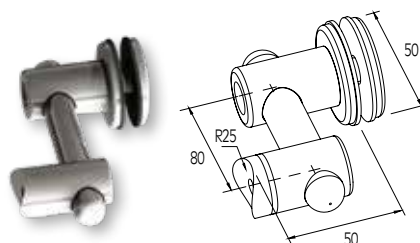

ΣΤΗΡΙΣΜΑ ΤΖΑΜΙΟΥ ΜΟΝΟ 8-10mm ΓΙΑ ΚΟΛΩΝΑ Ø50
SINGLE GLASS SUPPORT 8-10mm FOR Ø50 COLUMN

ΚΩΔ. / CODE	4181
ΤΙΜΗ / PRICE	19,30 €/pc

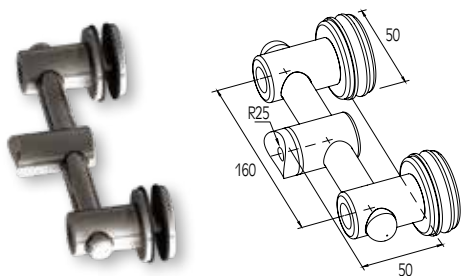

ΣΤΗΡΙΓΜΑ ΤΖΑΜΙΟΥ ΔΙΠΛΟ 8-10mm ΓΙΑ ΚΟΛΩΝΑ Ø50
SINGLE GLASS SUPPORT 8-10mm FOR Ø50 COLUMN

ΚΩΔ. / CODE	4182
ΤΙΜΗ / PRICE	32,00 €/pc

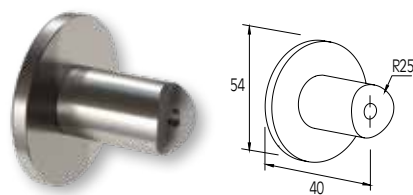

ΕΞΩΤΕΡΙΚΟ ΣΤΗΡΙΓΜΑ ΚΟΛΩΝΑΣ F50-101
EXTERNAL SUPPORT FOR F50-101 COLUMN

ΚΩΔ. / CODE	4184
ΤΙΜΗ / PRICE	3,40 €/pc

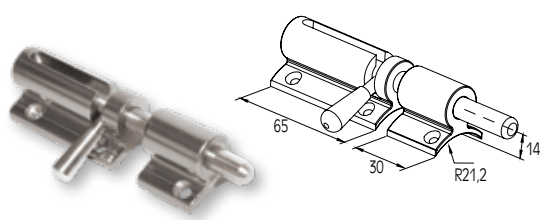

ΣΥΡΤΗΣ ΚΟΛΩΝΑΣ F50-100
BOLT FOR F50-100 COLUMN

ΚΩΔ. / CODE	4186
ΤΙΜΗ / PRICE	7,45 €/pc

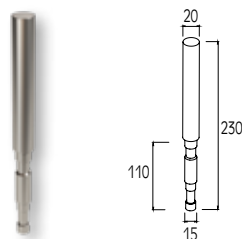

ΕΝΔΟΔΑΠΕΔΙΟ ΣΤΗΡΙΓΜΑ ΚΟΛΩΝΑΣ F50-102
INFLOOR SUPPORT FOR F50-102 COLUMN

ΚΩΔ. / CODE	4188
ΤΙΜΗ / PRICE	2,55 €/pc

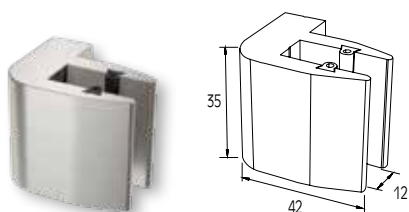

ΕΞΩΤΕΡΙΚΟ ΣΤΗΡΙΓΜΑ ΤΖΑΜΙΟΥ ΜΟΝΟ 8-10mm ΓΙΑ ΚΟΛΩΝΑ F50-102
EXTERNAL SINGLE GLASS SUPPORT 8-10mm FOR F50-102 COLUMN

ΚΩΔ. / CODE	4189
ΤΙΜΗ / PRICE	3,45 €/pc

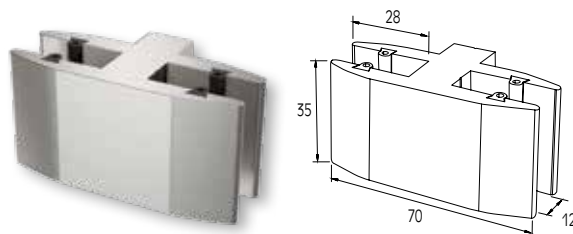

ΕΞΩΤΕΡΙΚΟ ΣΤΗΡΙΓΜΑ ΤΖΑΜΙΟΥ ΔΙΠΛΟ 8-10mm ΓΙΑ ΚΟΛΩΝΑ F50-102
EXTERNAL DOUBLE GLASS SUPPORT 8-10mm FOR F50-102 COLUMN

ΚΩΔ. / CODE	4190
ΤΙΜΗ / PRICE	5,30 €/pc

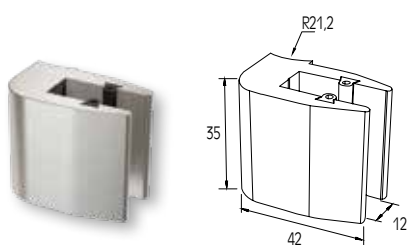

ΣΤΗΡΙΓΜΑ ΤΖΑΜΙΟΥ 8-10mm ΜΟΝΟ ΓΙΑ ΚΟΛΩΝΑ F50-103
SINGLE GLASS SUPPORT 8-10mm FOR F50-103 COLUMN

ΚΩΔ. / CODE	4191
ΤΙΜΗ / PRICE	3,85 €/pc

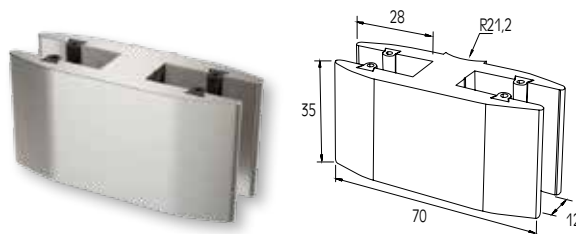

ΣΤΗΡΙΓΜΑ ΤΖΑΜΙΟΥ 8-10mm ΔΙΠΛΟ ΓΙΑ ΚΟΛΩΝΑ F50-103
DOUBLE GLASS SUPPORT 8-10mm FOR F50-103 COLUMN

ΚΩΔ. / CODE	4192
ΤΙΜΗ / PRICE	5,70 €/pc

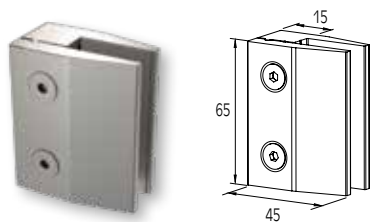

ΣΤΗΡΙΓΜΑ ΤΖΑΜΙΟΥ 8-10mm ΜΟΝΟ ΓΙΑ ΚΟΛΩΝΑ F50-102/106
SINGLE GLASS SUPPORT 8-10mm FOR F50-102/106 COLUMN

ΚΩΔ. / CODE	4193
ΤΙΜΗ / PRICE	4,95 €/pc

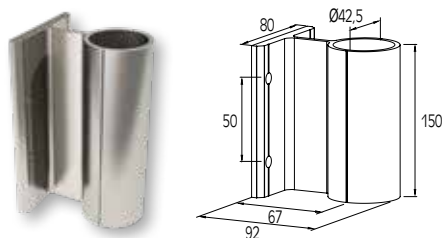

ΕΞΩΤΕΡΙΚΟ ΕΠΙΤΟΙΧΙΟ ΣΤΗΡΙΓΜΑ ΓΙΑ ΚΟΛΩΝΑ Ø42
EXTERNAL WALL SUPPORT FOR COLUMN Ø42

ΚΩΔ. / CODE	4194
ΤΙΜΗ / PRICE	13,10 €/pc

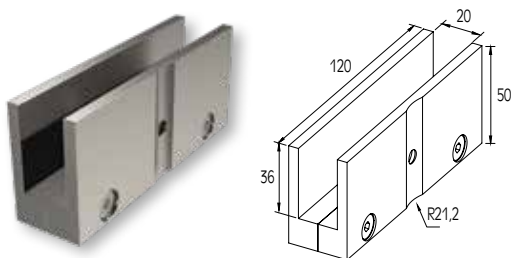

ΔΙΠΛΟ ΣΤΗΡΙΓΜΑ ΤΖΑΜΙΟΥ 19-22mm
DOUBLE GLASS SUPPORT 19-22mm

ΚΩΔ. / CODE	4195
ΤΙΜΗ / PRICE	10,50 €/pc

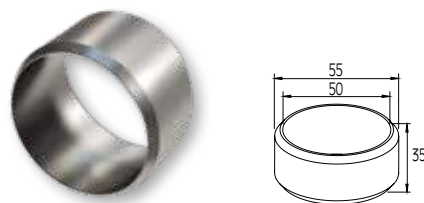

ΣΥΝΔΕΣΜΟΣ ΚΟΥΠΑΣΤΩΝ Ø50
CONNECTOR FOR HANDRAIL Ø50

ΚΩΔ. / CODE	4218
ΤΙΜΗ / PRICE	1,25 €/pc

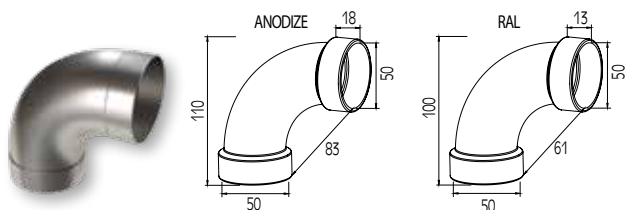

ΓΩΝΙΑΚΟΣ ΣΥΝΔΕΣΜΟΣ 90° ΚΟΥΠΑΣΤΩΝ Ø50
CONNECTOR 90° FOR HANDRAIL Ø50

ΚΩΔ. / CODE	4219
ΤΙΜΗ / PRICE	5,40 €/pc

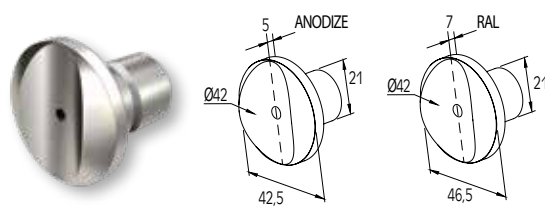

ΣΥΝΔΕΣΜΟΣ ΚΟΛΩΝΑΣ ΜΕ ΚΟΛΩΝΑ F50-100
CONNECTOR FOR COLUMN WITH COLUMN F50-100

ΚΩΔ. / CODE	4224
ΤΙΜΗ / PRICE	3,95 €/pc

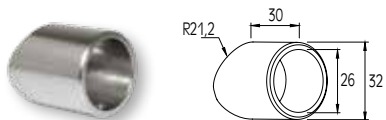

ΣΥΝΔΕΣΜΟΣ ΚΟΛΩΝΑΣ F50-100 ΜΕ ΠΡΟΦΙΛ Ø26
CONNECTOR FOR F50-100 COLUMN WITH PROFILE Ø26

ΚΩΔ. / CODE	4225
ΤΙΜΗ / PRICE	2,05 €/pc

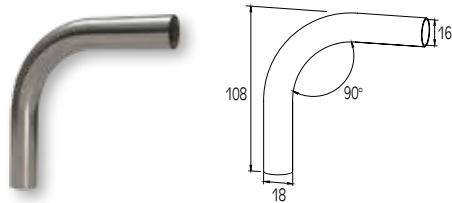

ΣΥΝΔΕΣΜΟΣ 90° ΓΙΑ ΠΡΟΦΙΛ Ø16
CONNECTOR 90° FOR PROFILE Ø16

ΚΩΔ. / CODE	4228
ΤΙΜΗ / PRICE	1,40 €/pc

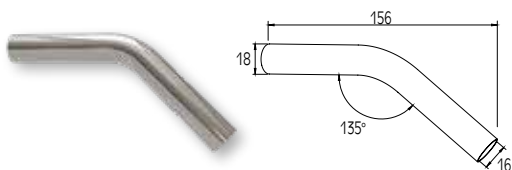

ΣΥΝΔΕΣΜΟΣ 135° ΓΙΑ ΠΡΟΦΙΛ Ø16
CONNECTOR 135° FOR PROFILE Ø16

ΚΩΔ. / CODE	4229
ΤΙΜΗ / PRICE	1,40 €/pc

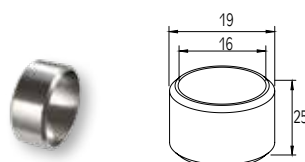

ΣΥΝΔΕΣΜΟΣ ΓΙΑ ΠΡΟΦΙΛ Ø16 (ΕΥΘΕΙΑ)
CONNECTOR FOR PROFILE Ø16 (STRAIGHT)

ΚΩΔ. / CODE	4230
ΤΙΜΗ / PRICE	0,85 €/pc

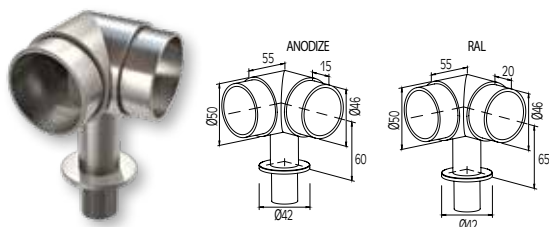

ΣΥΝΔΕΣΜΟΣ 90° ΓΙΑ ΚΟΥΠΙΑΣΤΗ Ø50
CONNECTOR 90° FOR HANDRAIL Ø50

ΚΩΔ. / CODE	4231
ΤΙΜΗ / PRICE	11,10 €/pc

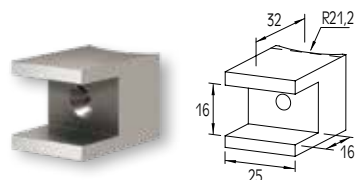

ΣΥΝΔΕΣΜΟΣ ΚΟΛΩΝΑΣ F50-100 ΜΕ ΠΡΟΦΙΛ F50-302
CONNECTOR FOR F50-100 COLUMN WITH F50-302 PROFILE

ΚΩΔ. / CODE	4232
ΤΙΜΗ / PRICE	3,85 €/pc

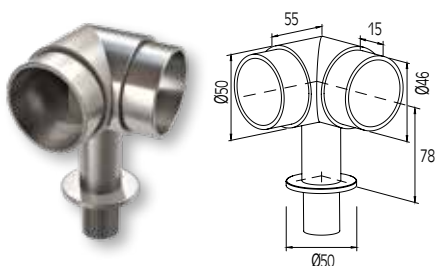

ΣΥΝΔΕΣΜΟΣ 90° ΓΙΑ ΚΟΥΠΙΑΣΤΗ Ø50
CONNECTOR 90° FOR HANDRAIL Ø50

ΚΩΔ. / CODE	4235
ΤΙΜΗ / PRICE	11,40 €/pc

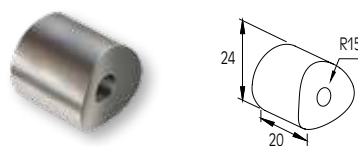

ΣΥΝΔΕΣΜΟΣ ΟΔΗΓΟΥ F50-307 ΜΕ ΚΟΛΩΝΑ F50-102
CONNECTOR FOR F50-307 GUIDE WITH F50-102 COLUMN

ΚΩΔ. / CODE	4240
ΤΙΜΗ / PRICE	1,70 €/pc

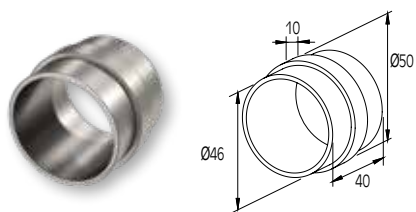

ΕΣΩΤΕΡΙΚΟΣ ΣΥΝΔΕΣΜΟΣ ΚΟΥΡΠΑΣΤΩΝ Ø50
CONNECTOR FOR HANDRAIL Ø50 (INTERNAL)

ΚΩΔ. / CODE **4241**

ΤΙΜΗ / PRICE **2,00 €/pc**

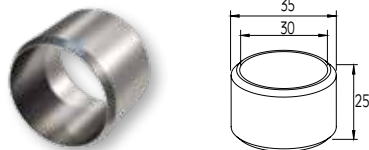

ΣΥΝΔΕΣΜΟΣ ΟΔΗΓΩΝ Ø30 ΓΙΑ ΕΥΘΕΙΑ
CONNECTOR FOR GUIDE Ø30 (STRAIGHT)

ΚΩΔ. / CODE **4242**

ΤΙΜΗ / PRICE **0,95 €/pc**

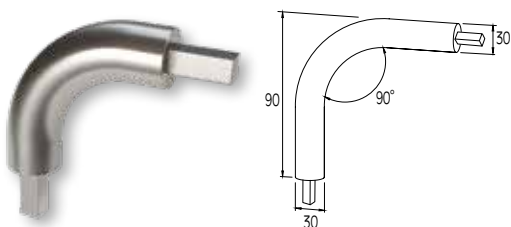

ΣΥΝΔΕΣΜΟΣ 90° ΓΙΑ ΟΔΗΓΟ F50-307
CONNECTOR 90° FOR F50-307 GUIDE

ΚΩΔ. / CODE **4243**

ΤΙΜΗ / PRICE **5,45 €/pc**

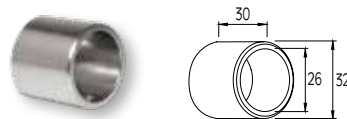

ΣΥΝΔΕΣΜΟΣ ΚΟΛΩΝΑΣ F50-102/106 ΜΕ ΠΡΟΦΙΛ Ø26
CONNECTOR FOR F50-102/106 COLUMN WITH PROFILE Ø26

ΚΩΔ. / CODE **4244**

ΤΙΜΗ / PRICE **2,65 €/pc**

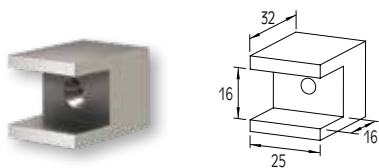

ΣΥΝΔΕΣΜΟΣ ΚΟΛΩΝΑΣ F50-102/106 ΜΕ ΠΡΟΦΙΛ F50-302
CONNECTOR FOR F50-102/106 COLUMN WITH PROFILE F50-302

ΚΩΔ. / CODE **4245**

ΤΙΜΗ / PRICE **4,00 €/pc**

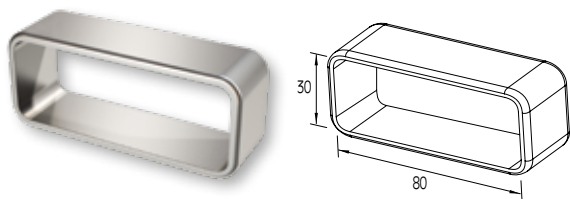

ΣΥΝΔΕΣΜΟΣ ΚΟΥΠΑΣΤΩΝ 80x30 ΕΥΘΕΙΑ
CONNECTOR FOR 80x30 HANDRAIL (STRAIGHT)

ΚΩΔ. / CODE **4249**

ΤΙΜΗ / PRICE **3,05 €/pc**

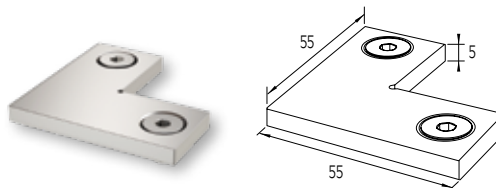

ΣΥΝΔΕΣΜΟΣ 90° ΓΙΑ ΚΟΥΠΑΣΤΗ F50-201
CONNECTOR 90° FOR F50-201 HANDRAIL

ΚΩΔ. / CODE **4250**

ΤΙΜΗ / PRICE **4,45 €/pc**

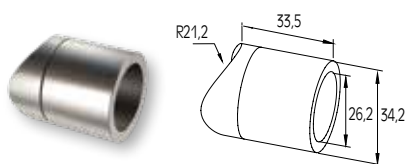

ΣΥΝΔΕΣΜΟΣ ΚΟΛΩΝΑΣ F50-100 ΜΕ ΠΡΟΦΙΛ Ø26
CONNECTOR FOR F50-100 COLUMN WITH PROFILE Ø26

ΚΩΔ. / CODE **4252**

ΤΙΜΗ / PRICE **5,05 €/pc**

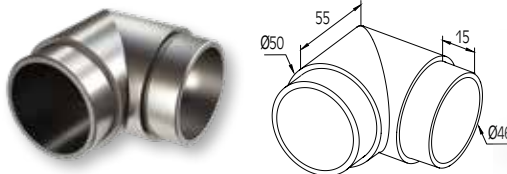

ΣΥΝΔΕΣΜΟΣ 90° ΓΙΑ ΚΟΥΠΑΣΤΗ Ø50
CONNECTOR 90° FOR HANDRAIL Ø50

ΚΩΔ. / CODE **4256**

ΤΙΜΗ / PRICE **6,05 €/pc**

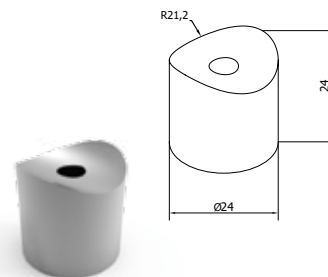

ΣΥΝΔΕΣΜΟΣ ΚΟΛΩΝΑΣ F50-100 ΜΕ ΚΟΛΩΝΑ F50-102
CONNECTOR FOR F50-100 COLUMN WITH F50-102 COLUMN

ΚΩΔ. / CODE **4266**

ΤΙΜΗ / PRICE **2,35 €/pc**

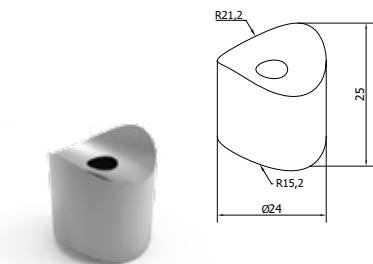

ΣΥΝΔΕΣΜΟΣ F50-307/327 ΜΕ ΚΟΛΩΝΑ F50-103/123
CONNECTOR FOR F50/307-327 WITH F50-103/123 COLUMN

ΚΩΔ. / CODE **4269**

ΤΙΜΗ / PRICE **2,10 €/pc**

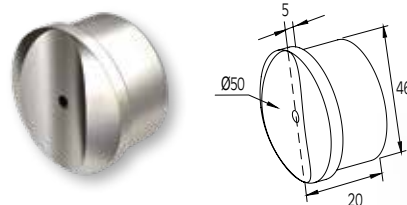

ΣΥΝΔΕΣΜΟΣ ΚΟΥΠΑΣΤΗΣ - ΚΟΥΠΑΣΤΗΣ F50-200
CONNECTOR FOR HANDRAIL WITH HANDRAIL F50-200

ΚΩΔ. / CODE **4257**

ΤΙΜΗ / PRICE **5,05 €/pc**

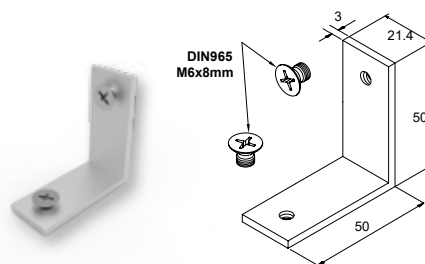

ΓΩΝΙΑ ΣΥΝΔΕΣΗΣ ΟΔΗΓΟΥ F50-319
CONNECTOR FOR F50-319 GUIDE

ΚΩΔ. / CODE **4259**

ΤΙΜΗ / PRICE **1,90 €/pc**

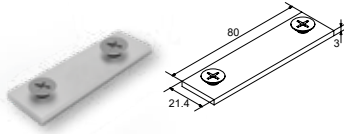

ΕΥΘΕΙΑ ΓΩΝΙΑ ΣΥΝΔΕΣΗΣ ΟΔΗΓΟΥ F50-319
LINEAR CONNECTOR FOR F50-319 GUIDE

ΚΩΔ. / CODE	4281
ΤΙΜΗ / PRICE	1,55 €/pc

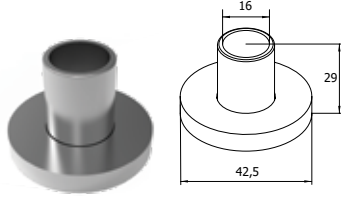

ΒΑΣΗ ΣΤΗΡΙΞΗΣ ΜΕ ΑΡΜΟΚΑΛΛΥΠΤΡΟ ΓΙΑ Ø16
CONNECTOR WITH COVER FOR PROFILE Ø16

ΚΩΔ. / CODE	4284
ΤΙΜΗ / PRICE	4,45 €/pc

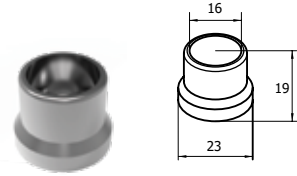

ΒΑΣΗ ΣΤΗΡΙΞΗΣ ΓΙΑ Ø16
CONNECTOR FOR PROFILE Ø16

ΚΩΔ. / CODE	4285
ΤΙΜΗ / PRICE	1,45 €/pc

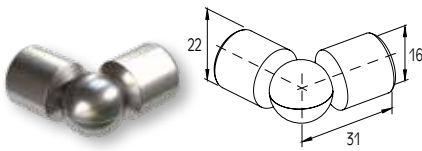

ΣΥΝΔΕΣΜΟΣ ΜΕΤΑΒΛΗΤΗΣ ΓΩΝΙΑΣ ΓΙΑ ΠΡΟΦΙΛ Ø16
ADJUSTABLE ANGLE CONNECTOR FOR PROFILE Ø16

ΚΩΔ. / CODE	4302
ΤΙΜΗ / PRICE	3,95 €/pc

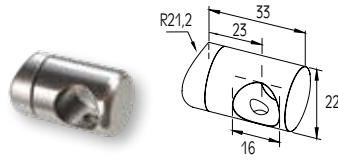

ΣΥΝΔΕΣΜΟΣ ΚΟΛΩΝΑΣ F50-100 ΜΕ ΠΡΟΦΙΛ Ø16
CONNECTOR FOR F50-100 COLUMN WITH PROFILE Ø16

ΚΩΔ. / CODE	4312
ΤΙΜΗ / PRICE	2,10 €/pc

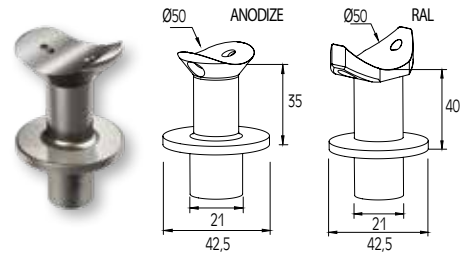

ΣΥΝΔΕΣΜΟΣ ΚΟΥΠΙΑΣΤΗΣ Ø50 ΜΕ ΚΟΛΩΝΑ Ø42
CONNECTOR FOR HANDRAIL Ø50 WITH COLUMN Ø42

ΚΩΔ. / CODE	4314
ΤΙΜΗ / PRICE	3,10 €/pc

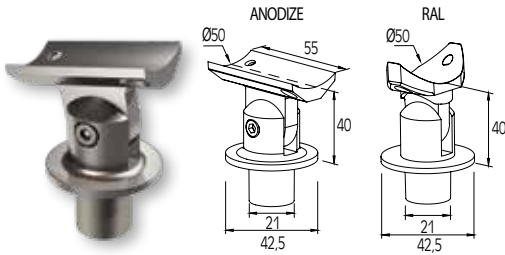

ΣΥΝΔΕΣΜΟΣ ΚΟΥΠΙΑΣΤΗΣ Ø50 ΜΕ ΚΟΛΩΝΑ Ø42 (ΣΚΑΛΑ)
CONNECTOR FOR HANDRAIL Ø50 WITH COLUMN Ø42 (STAIRS)

ΚΩΔ. / CODE	4316
ΤΙΜΗ / PRICE	4,15 €/pc

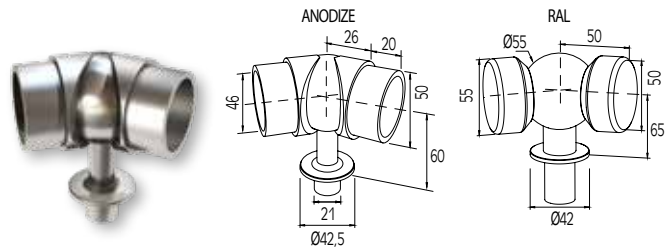

ΣΥΝΔΕΣΜΟΣ ΜΕΤΑΒΛΗΤΗΣ ΓΩΝΙΑΣ ΚΟΥΠΙΑΣΤΗΣ Ø50 ΜΕ ΚΟΛΩΝΑ Ø42
ADJUSTABLE CORNER CONNECTOR FOR HANDRAIL Ø50 WITH COLUMN Ø42

ΚΩΔ. / CODE	4319
ΤΙΜΗ / PRICE	18,90 €/pc

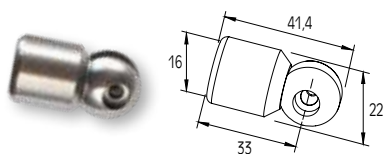

ΣΥΝΔΕΣΜΟΣ ΡΟΖΕΤΑΣ ΤΖΑΜΙΟΥ ΜΕ ΠΡΟΦΙΛ Ø16
CONNECTOR FOR GLASS ROSSETE WITH PROFILE Ø16

ΚΩΔ. / CODE	4322
ΤΙΜΗ / PRICE	2,70 €/pc

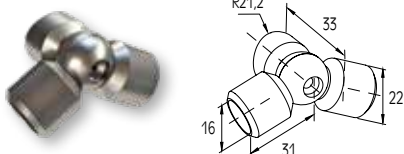

ΣΥΝΔΕΣΜΟΣ ΜΕΤΑΒΛΗΤΗΣ ΓΩΝΙΑΣ ΠΡΟΦΙΛ Ø16 ΜΕ ΚΟΛΩΝΑ F50-100
ADJUSTABLE CORNER CONNECTOR FOR PROFILE Ø16 WITH F50-100 COLUMN

ΚΩΔ. / CODE	4323
ΤΙΜΗ / PRICE	7,10 €/pc

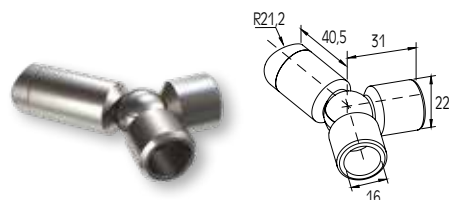

ΓΩΝΙΑΚΟΣ ΣΥΝΔΕΣΜΟΣ ΠΡΟΦΙΛ Ø16 ΜΕ ΚΟΛΩΝΑ F50-100
CONNECTOR 90° FOR PROFILE Ø16 WITH F50-100 COLUMN

ΚΩΔ. / CODE	4324
ΤΙΜΗ / PRICE	4,75 €/pc

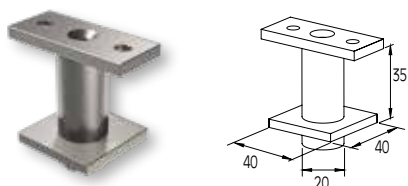

ΣΤΗΡΙΓΜΑ ΚΟΛΩΝΑΣ F50-102 ΜΕ ΚΟΥΠΑΣΤΗ F50-201
SUPPORT FOR F50-102 COLUMN WITH F50-201 HANDRAIL

ΚΩΔ. / CODE	4328
ΤΙΜΗ / PRICE	4,75 €/pc

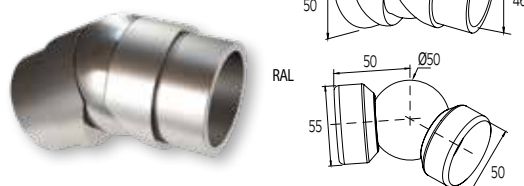

ΣΥΝΔΕΣΜΟΣ ΜΕΤΑΒΛΗΤΗΣ ΓΩΝΙΑΣ ΚΟΥΠΑΣΤΩΝ Ø50
ADJUSTABLE CORNER CONNECTOR FOR COLUMN Ø50

ΚΩΔ. / CODE	4329
ΤΙΜΗ / PRICE	9,20 €/pc

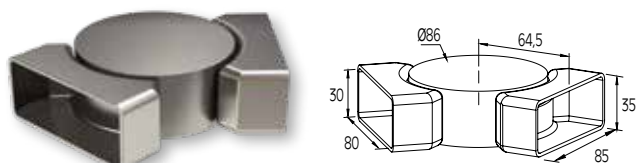

ΣΥΝΔΕΣΜΟΣ ΜΕΤΑΒΛΗΤΗΣ ΓΩΝΙΑΣ ΚΟΥΠΑΣΤΗΣ F50-201/203
ADJUSTABLE CORNER CONNECTOR FOR F50-201/203 HANDRAIL

ΚΩΔ. / CODE	4332
ΤΙΜΗ / PRICE	15,40 €/pc

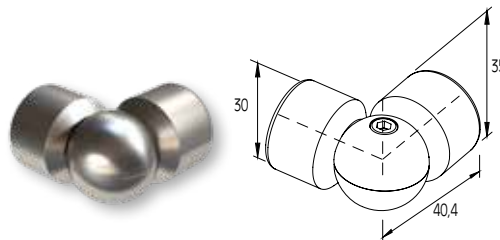

ΣΥΝΔΕΣΜΟΣ ΜΕΤΑΒΛΗΤΗΣ ΓΩΝΙΑΣ ΟΔΗΓΟΥ F50-307
ADJUSTABLE CORNER CONNECTOR FOR F50-307 GUIDE

ΚΩΔ. / CODE	4333
ΤΙΜΗ / PRICE	7,00 €/pc

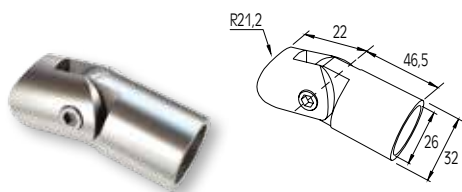

ΣΥΝΔΕΣΜΟΣ ΚΟΛΩΝΑΣ F50-100 ΜΕ ΠΡΟΦΙΛ Ø26
CONNECTOR FOR F50-100 COLUMN WITH PROFILE Ø26

ΚΩΔ. / CODE	4335
ΤΙΜΗ / PRICE	8,50 €/pc

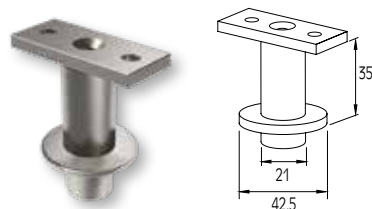

ΣΥΝΔΕΣΜΟΣ ΚΟΛΩΝΑΣ F50-100 ΜΕ ΚΟΥΠΙΑΣΤΗ F50-201
CONNECTOR FOR F50-100 COLUMN WITH F50-201 HANDRAIL

ΚΩΔ. / CODE	4337
ΤΙΜΗ / PRICE	5,40 €/pc

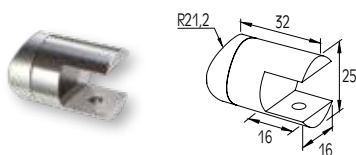

ΣΥΝΔΕΣΜΟΣ ΚΟΛΩΝΑΣ F50-100 ΜΕ ΠΡΟΦΙΛ F50-302
CONNECTOR FOR F50-100 COLUMN WITH F50-302 PROFILE

ΚΩΔ. / CODE	4341
ΤΙΜΗ / PRICE	4,15 €/pc

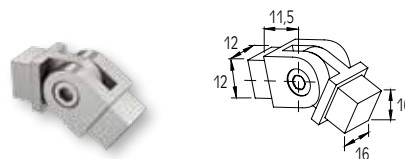

ΣΥΝΔΕΣΜΟΣ ΜΕΤΑΒΛΗΤΗΣ ΓΩΝΙΑΣ ΠΡΟΦΙΛ F50-302
ADJUSTABLE CORNER CONNECTOR FOR F50-302 PROFILE

ΚΩΔ. / CODE	4342
ΤΙΜΗ / PRICE	9,55 €/pc

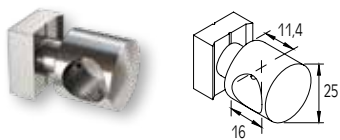

ΣΥΝΔΕΣΜΟΣ ΠΡΟΦΙΛ Ø16 ΜΕ ΚΟΛΩΝΑ BLADE
CONNECTOR FOR PROFILE Ø16 WITH BLADE COLUMN

ΚΩΔ. / CODE	4343
ΤΙΜΗ / PRICE	3,65 €/pc

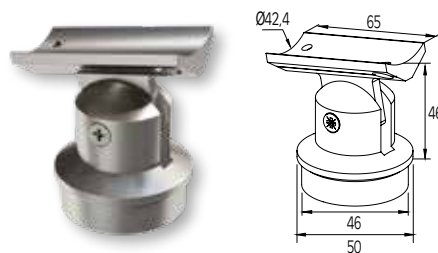

ΣΥΝΔΕΣΜΟΣ ΚΟΛΩΝΑΣ F50-100 ΜΕ ΚΟΥΠΙΑΣΤΗ F50-200
CONNECTOR FOR F50-100 COLUMN WITH F50-200 HANDRAIL

ΚΩΔ. / CODE	4344
ΤΙΜΗ / PRICE	6,35 €/pc

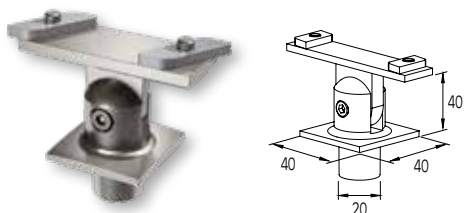

ΣΥΝΔΕΣΜΟΣ ΚΟΛΩΝΑΣ F50-102 ΜΕ ΚΟΥΠΑΣΤΗ F50-201
CONNECTOR FOR F50-102 COLUMN WITH F50-201 HANDRAIL

ΚΩΔ. / CODE	4345
ΤΙΜΗ / PRICE	5,90 €/pc

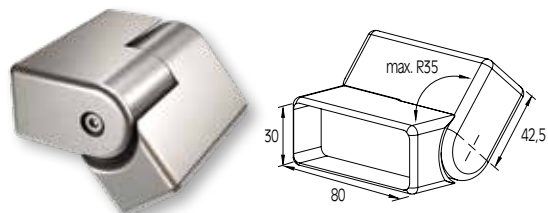

ΣΥΝΔΕΣΜΟΣ ΜΕΤΑΒΛΗΤΗΣ ΓΩΝΙΑΣ ΚΟΥΠΑΣΤΩΝ 80x30 ΣΚΑΛΑ
ADJUSTABLE CORNER CONNECTOR FOR 80x30 HANDRAIL (STAIRS)

ΚΩΔ. / CODE	4346
ΤΙΜΗ / PRICE	23,20 €/pc

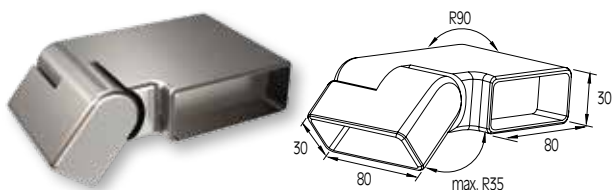

ΣΥΝΔΕΣΜΟΣ 90° ΜΕΤΑΒΛΗΤΗΣ ΓΩΝΙΑΣ ΚΟΥΠΑΣΤΩΝ 80x30 (ΣΚΑΛΑ)
ADJUSTABLE CORNER CONNECTOR 90° FOR 80x30 HANDRAIL (STAIRS)

ΚΩΔ. / CODE	4347
ΤΙΜΗ / PRICE	41,30 €/pc

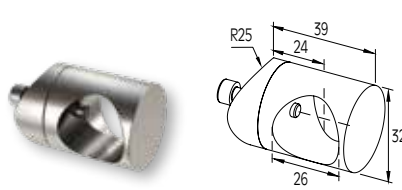

ΣΥΝΔΕΣΜΟΣ ΚΟΛΩΝΑΣ F50-101 ΜΕ ΠΡΟΦΙΛ Ø26
CONNECTOR FOR F50-101 COLUMN WITH PROFILE Ø26

ΚΩΔ. / CODE	4348
ΤΙΜΗ / PRICE	5,90 €/pc

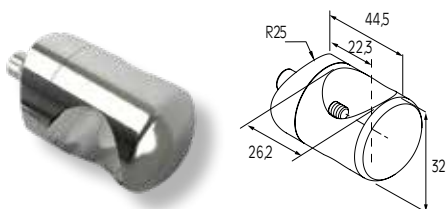

ΣΥΝΔΕΣΜΟΣ ΟΒΑΛ ΚΟΛΩΝΑΣ F50-101 ΜΕ ΠΡΟΦΙΛ Ø26
CONNECTOR OVAL FOR F50-101 COLUMN WITH PROFILE Ø26

ΚΩΔ. / CODE	4348B
ΤΙΜΗ / PRICE	6,20 €/pc

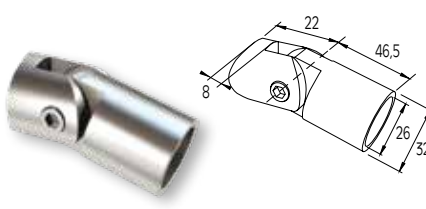

ΣΥΝΔΕΣΜΟΣ ΚΟΛΩΝΑΣ F50-102 ΜΕ ΠΡΟΦΙΛ Ø26
CONNECTOR FOR F50-102 COLUMN WITH PROFILE Ø26

ΚΩΔ. / CODE	4349
ΤΙΜΗ / PRICE	8,05 €/pc

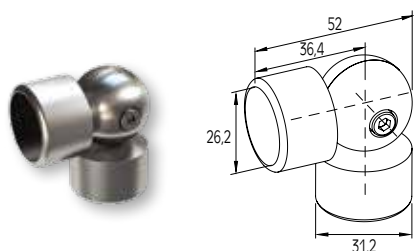

ΣΥΝΔΕΣΜΟΣ ΜΕΤΑΒΛΗΤΗΣ ΓΩΝΙΑΣ ΠΡΟΦΙΛ Ø26
ADJUSTABLE CORNER CONNECTOR FOR PROFILE Ø26

ΚΩΔ. / CODE	4352
ΤΙΜΗ / PRICE	7,00 €/pc

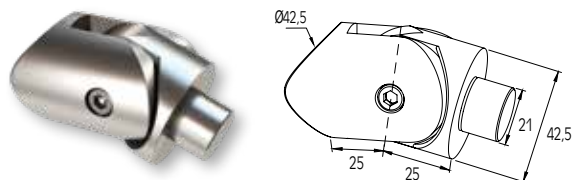

ΣΥΝΔΕΣΜΟΣ ΚΟΛΩΝΑΣ ΜΕ ΚΟΛΩΝΑ F50-100 (ΣΚΑΛΑ)
CONNECTOR FOR COLUMN WITH COLUMN F50-100 (STAIRS)

ΚΩΔ. / CODE	4355
ΤΙΜΗ / PRICE	14,90 €/pc

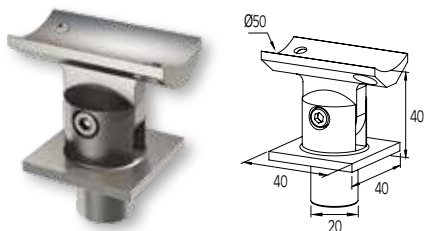

ΣΤΗΡΙΓΜΑ ΚΟΥΠΑΣΤΗΣ F50-200 ΜΕ ΚΟΛΩΝΑ F50-102 (ΣΚΑΛΑ)
SUPPORT FOR F50-200 HANDRAIL WITH F50-102 COLUMN (STAIRS)

ΚΩΔ. / CODE	4356
ΤΙΜΗ / PRICE	4,45 €/pc

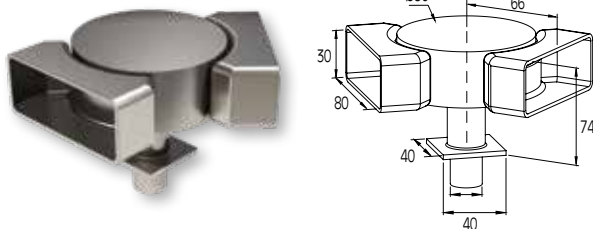

ΣΥΝΔΕΣΜΟΣ ΜΕΤΑΒΛΗΤΗΣ ΓΩΝΙΑΣ ΚΟΥΠΑΣΤΗΣ 80x30 ΜΕ ΚΟΛΩΝΑ F50-102
ADJUSTABLE CORNER CONNECTOR FOR 80x30 HANDRAIL WITH F50-102 COLUMN

ΚΩΔ. / CODE	4357
ΤΙΜΗ / PRICE	20,50 €/pc

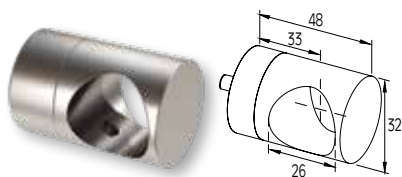

ΣΥΝΔΕΣΜΟΣ ΚΟΛΩΝΑΣ F50-102 ΜΕ ΠΡΟΦΙΛ Ø26
CONNECTOR FOR F50-102 COLUMN WITH PROFILE Ø26

ΚΩΔ. / CODE	4358
ΤΙΜΗ / PRICE	6,00 €/pc

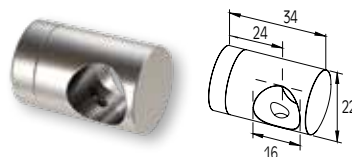

ΣΥΝΔΕΣΜΟΣ ΚΟΛΩΝΑΣ F50-102 ΜΕ ΠΡΟΦΙΛ Ø16
CONNECTOR FOR F50-102 COLUMN WITH PROFILE Ø16

ΚΩΔ. / CODE	4359
ΤΙΜΗ / PRICE	2,60 €/pc

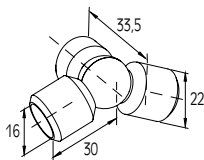

ΣΥΝΔΕΣΜΟΣ ΜΕΤΑΒΛΗΤΗΣ ΓΩΝΙΑΣ ΠΡΟΦΙΛ Ø16 ΜΕ ΚΟΛΩΝΑ F50-102
ADJUSTABLE CORNER CONNECTOR FOR PROFILE Ø16 WITH F50-102 COLUMN

ΚΩΔ. / CODE **4360**

ΤΙΜΗ / PRICE **8,60 €/pc**

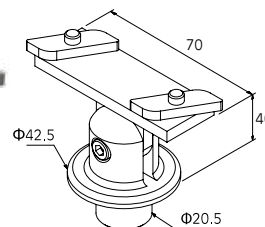

ΣΤΗΡΙΓΜΑ ΚΟΥΠΑΣΤΗΣ F50-201 ΜΕ ΚΟΛΩΝΑ F50-100 (ΣΚΑΛΑ)
SUPPORT FOR F50-201 HANDRAIL WITH F50-100 COLUMN (STAIRS)

ΚΩΔ. / CODE **4361**

ΤΙΜΗ / PRICE **6,35 €/pc**

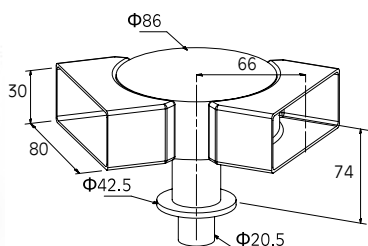
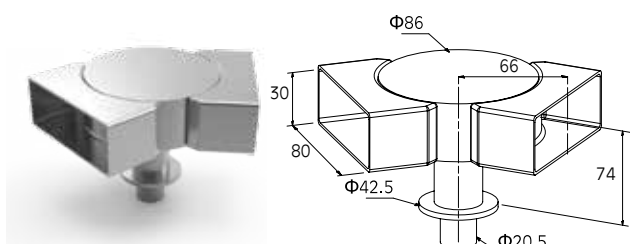

ΣΥΝΔΕΣΜΟΣ ΜΕΤΑΒΛΗΤΗΣ ΓΩΝΙΑΣ ΚΟΥΠΑΣΤΗΣ 80x30 ΜΕ ΚΟΛΩΝΑΣ F50-100
ADJUSTABLE CORNER CONNECTOR FOR HANDRAIL 80x30 WITH COLUMN F50-100

ΚΩΔ. / CODE **4373**

ΤΙΜΗ / PRICE **21,00 €/pc**

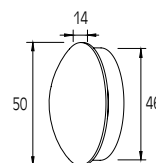

ΤΑΠΑ ΚΟΥΠΑΣΤΗΣ F50-200
END CAP FOR F50-200 HANDRAIL

ΚΩΔ. / CODE **4434**

ΤΙΜΗ / PRICE **1,45 €/pc**

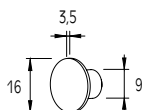

ΤΑΠΑ ΓΙΑ ΠΡΟΦΙΛ F50-301
END CAP FOR F50-301 PROFILE

ΚΩΔ. / CODE **4435**

ΤΙΜΗ / PRICE **0,45 €/pc**

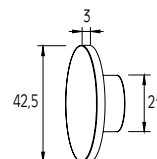

ΤΑΠΑ ΚΟΛΩΝΑΣ F50-100
END CAP FOR F50-100 COLUMN

ΚΩΔ. / CODE **4436**

ΤΙΜΗ / PRICE **1,60 €/pc**

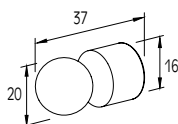

ΤΕΛΕΙΩΜΑ ΓΙΑ ΠΡΟΦΙΛ Ø16
END COVER FOR PROFILE Ø16

ΚΩΔ. / CODE **4437**

ΤΙΜΗ / PRICE **1,45 €/pc**

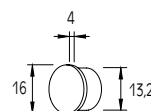

ΤΑΠΑ ΓΙΑ ΠΡΟΦΙΛ F50-300
END CAP FOR F50-300 PROFILE

ΚΩΔ. / CODE **4438**

ΤΙΜΗ / PRICE **0,55 €/pc**

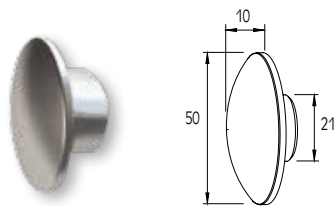

ΤΑΠΑ ΚΟΛΩΝΑΣ F50-101
END CAP FOR F50-101 COLUMN

ΚΩΔ. / CODE	4443
ΤΙΜΗ / PRICE	2,90 €/pc

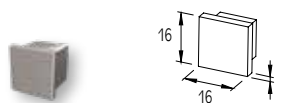

ΤΑΠΑ ΓΙΑ ΠΡΟΦΙΛ F50-302
END CAP FOR F50-302 PROFILE

ΚΩΔ. / CODE	4444
ΤΙΜΗ / PRICE	0,95 €/pc

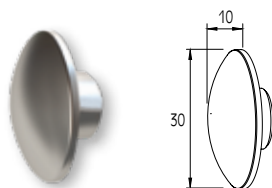

ΤΑΠΑ ΟΔΗΓΟΥ F50-307
END CAP FOR F50-307 GUIDE

ΚΩΔ. / CODE	4446
ΤΙΜΗ / PRICE	1,45 €/pc

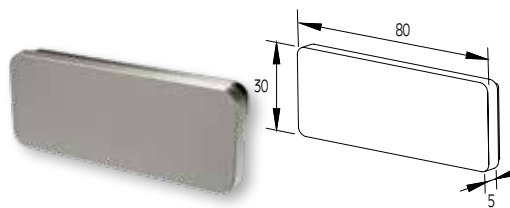

ΤΑΠΑ ΚΟΥΠΑΣΤΗΣ F50-201
END CAP FOR F50-201 HANDRAIL

ΚΩΔ. / CODE	4447
ΤΙΜΗ / PRICE	2,70 €/pc

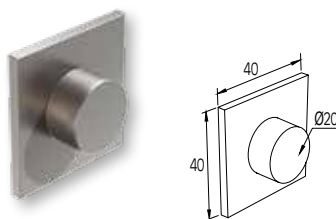

ΤΑΠΑ ΚΟΛΩΝΑΣ F50-102
END CAP FOR F50-102 COLUMN

ΚΩΔ. / CODE	4448
ΤΙΜΗ / PRICE	1,75 €/pc

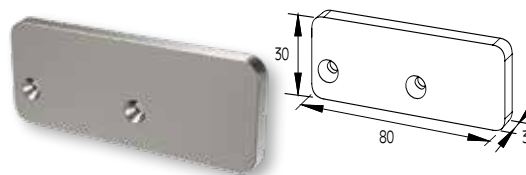

ΤΑΠΑ ΚΟΥΠΑΣΤΗΣ F50-203
END CAP FOR F50-203 HANDRAIL

ΚΩΔ. / CODE	4451
ΤΙΜΗ / PRICE	4,75 €/pc

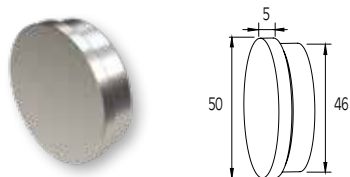

ΤΑΠΑ ΚΟΥΠΑΣΤΗΣ F50-200 (ΕΠΙΠΕΔΗ)
END CAP FOR F50-200 HANDRAIL (FLAT)

ΚΩΔ. / CODE	4453
ΤΙΜΗ / PRICE	2,25 €/pc

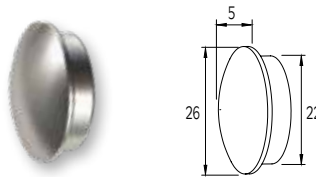

ΤΑΠΑ ΓΙΑ ΠΡΟΦΙΛ F50-304
END CAP FOR F50-304 PROFILE

ΚΩΔ. / CODE	4461
ΤΙΜΗ / PRICE	1,30 €/pc

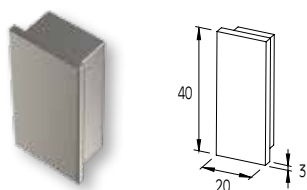

ΤΑΠΑ ΓΙΑ ΠΡΟΦΙΛ 59-009 (40x20)
END CAP FOR PROFILE 59-009 (40x20)

ΚΩΔ. / CODE	4464
ΤΙΜΗ / PRICE	2,90 €/pc

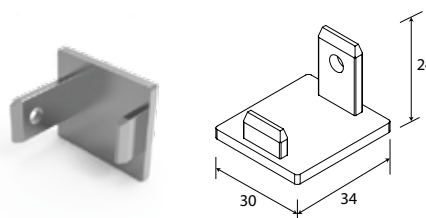

ΤΑΠΑ ΟΔΗΓΟΥ F50-319
END CAP FOR F50-319 GUIDE

ΚΩΔ. / CODE	4477
ΤΙΜΗ / PRICE	2,70 €/pc

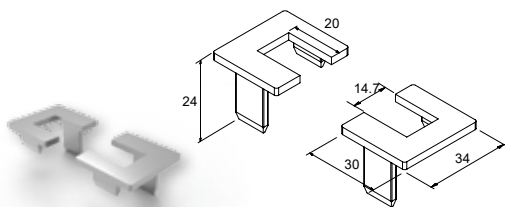

ΤΑΠΑ ΟΔΗΓΟΥ F50-319 (ΣΚΙΣΤΗ)
END CAP FOR F50-319 GUIDE (PERFORATED)

ΚΩΔ. / CODE	4478
ΤΙΜΗ / PRICE	7,40 €/pair

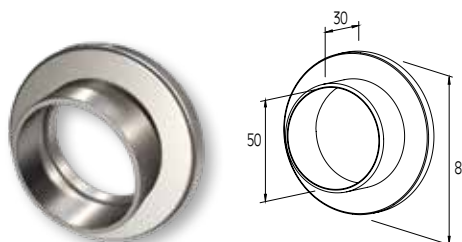

ΑΡΜΟΚΑΛΥΠΤΡΟ ΚΟΥΠΑΣΤΗΣ Ø50 ΜΕ ΚΑΠΑΚΙ
WALL COVER FOR HANDRAIL Ø50 WITH CAP

ΚΩΔ. / CODE	4509Z
ΤΙΜΗ / PRICE	5,20 €/pc

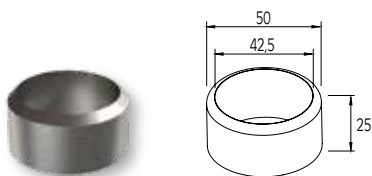

ΑΡΜΟΚΑΛΥΠΤΡΟ ΚΟΛΩΝΑΣ Ø42
WALL COVER FOR COLUMN Ø42

ΚΩΔ. / CODE	4510
ΤΙΜΗ / PRICE	1,25 €/pc

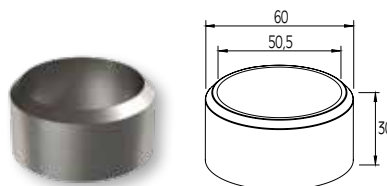

ΑΡΜΟΚΑΛΥΠΤΡΟ ΚΟΛΩΝΑΣ F50-101
WALL COVER FOR F50-101 COLUMN

ΚΩΔ. / CODE	4513
ΤΙΜΗ / PRICE	1,90 €/pc

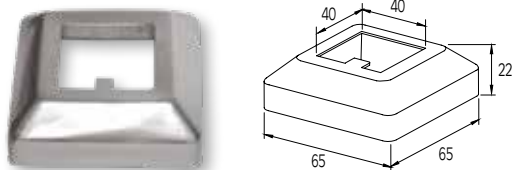

ΑΡΜΟΚΑΛΥΠΤΡΟ ΚΟΛΩΝΑΣ F50-102
WALL COVER FOR F50-102 COLUMN

ΚΩΔ. / CODE	4514
ΤΙΜΗ / PRICE	1,85 €/pc

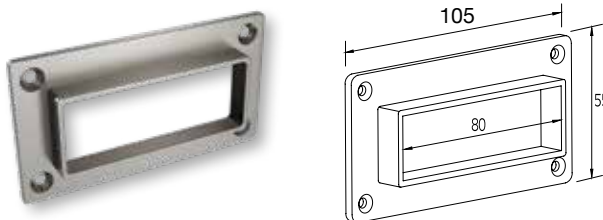

ΑΡΜΟΚΑΛΥΠΤΡΟ ΚΟΥΠΙΑΣΤΗΣ F50-201/203
WALL COVER FOR F50-201/203 HANDRAIL

ΚΩΔ. / CODE	4515
ΤΙΜΗ / PRICE	5,25 €/pc

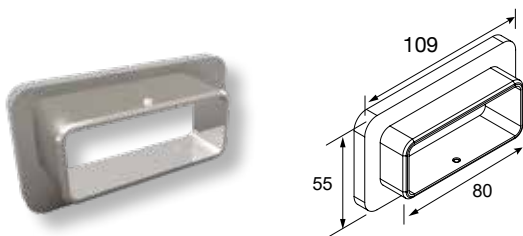

ΑΡΜΟΚΑΛΥΠΤΡΟ ΚΟΥΠΙΑΣΤΗΣ F50-201/203 (ΜΕ ΚΑΠΑΚΙ)
WALL COVER FOR F50-201/203 HANDRAIL (WITH CAP)

ΚΩΔ. / CODE	4515Z
ΤΙΜΗ / PRICE	7,95 €/pc

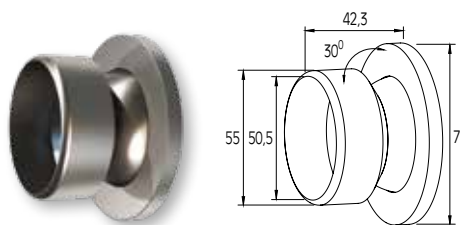

ΑΡΜΟΚΑΛΥΠΤΡΟ ΚΟΥΠΙΑΣΤΗΣ Ø50 (ΜΕ ΚΑΠΑΚΙ)
WALL COVER FOR HANDRAIL Ø50 WITH CAP

ΚΩΔ. / CODE	4518
ΤΙΜΗ / PRICE	9,10 €/pc

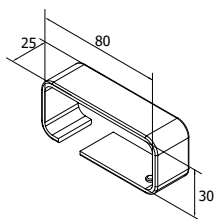

ΣΥΝΔΕΣΜΟΣ ΚΟΥΠΑΣΤΩΝ 80X30 ΕΥΘΕΙΑ
CONNECT.FOR 80X30 HANDR. (STRAIGHT)

ΚΩΔ. / CODE	4287
ΤΙΜΗ / PRICE	4,50 €/pc

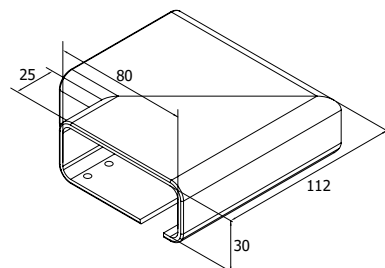

ΣΥΝΔΕΣΜΟΣ 90° ΚΟΥΠΑΣΤΩΝ 80X30
CONNECTOR 90° 80X30 HANDRAIL

ΚΩΔ. / CODE	4288
ΤΙΜΗ / PRICE	14,85 €/pc

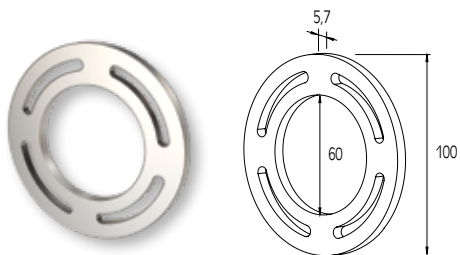

ΠΟΖΕΤΑ ΤΖΑΜΙΟΥ Ø100
GLASS ROSETTE Ø100

ΚΩΔ. / CODE	4611
ΤΙΜΗ / PRICE	4,75 €/pc

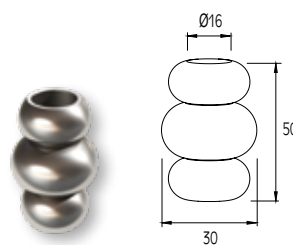

ΠΟΖΕΤΑ ΓΙΑ ΠΡΟΦΙΛ Ø16
GLASS ROSETTE FOR PROFILE Ø16

ΚΩΔ. / CODE	4618
ΤΙΜΗ / PRICE	2,90 €/pc

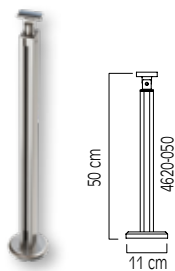

ΕΤΟΙΜΗ ΚΟΛΩΝΑ 50 cm ΓΙΑ ΠΡΟΦΙΛ Ø16
READY MADE COLUMN FOR Ø16 PROFILE HEIGHT 50 cm

ΚΩΔ. / CODE	4620-050
ΤΙΜΗ / PRICE	36,60 €/pc

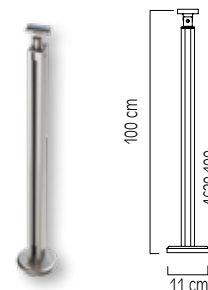

ΕΤΟΙΜΗ ΚΟΛΩΝΑ 100 cm ΓΙΑ ΠΡΟΦΙΛ Ø16
READY MADE COLUMN FOR Ø16 PROFILE HEIGHT 100 cm

ΚΩΔ. / CODE	4620-100
ΤΙΜΗ / PRICE	48,50 €/pc

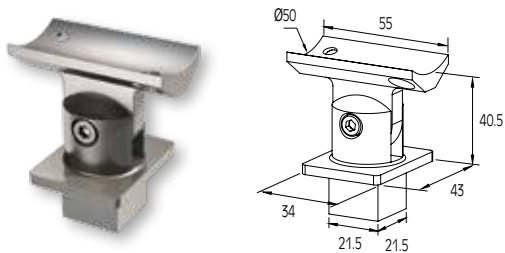

ΣΤΗΡΙΓΜΑ ΚΟΥΠΑΣΤΗΣ Ø50 ΜΕ ΚΟΛΩΝΑ BLADE
SUPPORT FOR HANDRAIL Ø50 WITH BLADE COLUMN

ΚΩΔ. / CODE	4620-310
ΤΙΜΗ / PRICE	7,35 €/pc

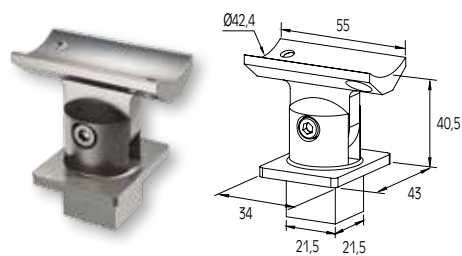

ΣΤΗΡΙΓΜΑ ΚΟΥΠΑΣΤΗΣ Ø42 ΜΕ ΚΟΛΩΝΑ BLADE
SUPPORT FOR HANDRAIL Ø42 WITH BLADE COLUMN

ΚΩΔ. / CODE	4620-311
ΤΙΜΗ / PRICE	7,85 €/pc

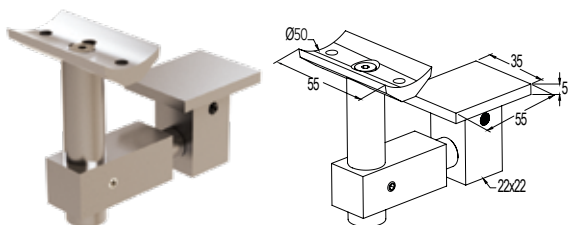

ΣΤΗΡΙΓΜΑ ΚΟΥΠΑΣΤΗΣ Ø50 ΜΕ ΚΟΛΩΝΑ BLADE
SUPPORT FOR HANDRAIL Ø50 WITH BLADE COLUMN

ΚΩΔ. / CODE	4620-312
ΤΙΜΗ / PRICE	12,50 €/pc

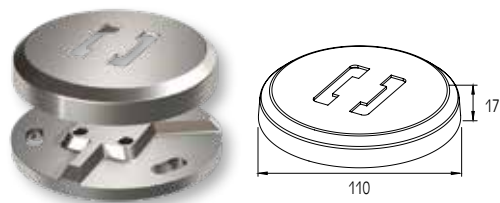

ΠΕΛΑΜΑ ΣΤΗΡΙΞΗΣ ΚΟΛΩΝΑΣ F50-108
SUPPORT FOOT FOR F50-108 COLUMN

ΚΩΔ. / CODE	4620-320
ΤΙΜΗ / PRICE	10,60 €/pc

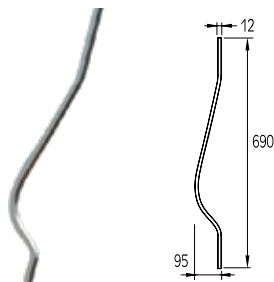

ΣΤΟΙΧΕΙΟ ΨΑΘΑΣ VERTICAL D (70cm)
CURVED PROFILE FOR VERTICAL-D (70cm)

ΚΩΔ. / CODE	4670
ΤΙΜΗ / PRICE	3,50 €/pc

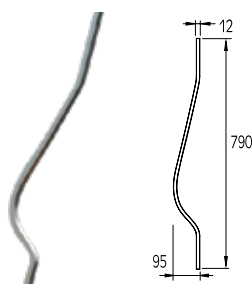

ΣΤΟΙΧΕΙΟ ΨΑΘΑΣ VERTICAL D (80cm)
CURVED PROFILE FOR VERTICAL-D (80cm)

ΚΩΔ. / CODE	4680
ΤΙΜΗ / PRICE	3,85 €/pc

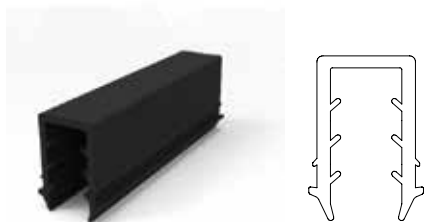

ΛΑΣΤΙΧΟ ΣΦΗΝΑ ΟΔΗΓΟΥ ΤΥΠΟΥ U ΓΙΑ ΤΖΑΜΙ 10.76mm
"U" SHAPE GASKET FOR 10.76mm GLASS

ΚΩΔ. / CODE	4910
ΤΙΜΗ / PRICE	2,70 €/m

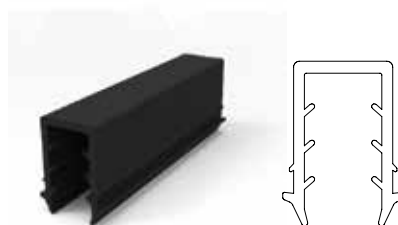

ΛΑΣΤΙΧΟ ΣΦΗΝΑ ΟΔΗΓΟΥ ΤΥΠΟΥ U ΓΙΑ ΤΖΑΜΙ 11.52mm
"U" SHAPE GASKET FOR 11.52mm GLASS

ΚΩΔ. / CODE	4911
ΤΙΜΗ / PRICE	2,40 €/m

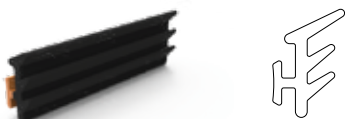

ΛΑΣΤΙΧΟ ΣΦΗΝΑ ΟΔΗΓΟΥ F50-319 ΓΙΑ ΤΖΑΜΙ 10mm
GASKET FOR F50-319 RAIL (10mm GLASS)

ΚΩΔ. / CODE	4912
ΤΙΜΗ / PRICE	0,45 €/m



ΣΦΗΝΑ ΚΟΥΜΠΩΤΗ ΤΖΑΜΙΟΥ 3mm ΜΑΥΡΟ
GLAZING GASKET 3mm BLACK

ΚΩΔ. / CODE	US530-3PRM
ΤΙΜΗ / PRICE	4,70 €/Kg

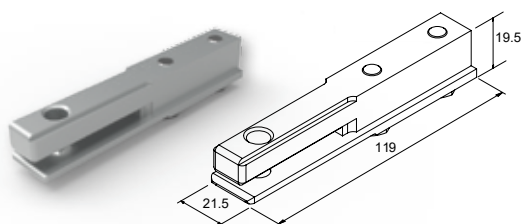

ΚΑΛΙΜΠΡΑ ΤΡΥΠΗΜΑΤΟΣ ΟΔΗΓΟΥ F50-319
HOLES CALIBRE FOR F50-319

ΚΩΔ. / CODE	4971
ΤΙΜΗ / PRICE	131,50 €/pc

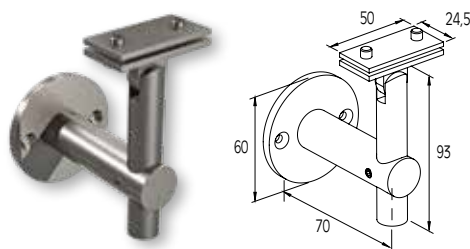

ΕΠΙΤΟΙΧΙΟ ΣΤΗΡΙΓΜΑ ΚΟΥΠΑΣΤΗΣ F50-201
F50-201 RAILTOP WALL SUPPORT

ΚΩΔ. / CODE	F85-452
ΤΙΜΗ / PRICE	14,70 €/pc

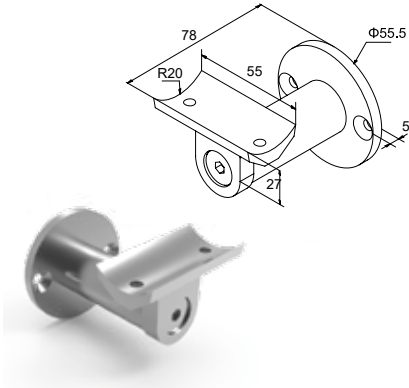

ΚΩΔ. / CODE **4135**
 ΕΠΙΤΟΙΧΙΟ ΣΤΗΡΙΓΜΑ ΚΟΥΠΑΣΤΗΣ Ø40
 WALL SUPPORT FOR Ø40 HANDRAIL
 ΤΙΜΗ / PRICE **6,05 €/pc**

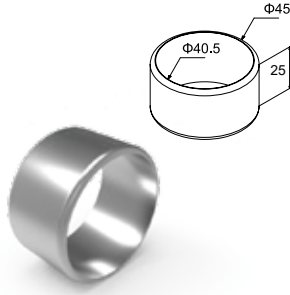

ΚΩΔ. / CODE **4260**
 ΣΥΝΔΕΣΜΟΣ ΚΟΥΠΑΣΤΗΣ Ø40
 CONNECTOR FOR HANDRAIL Ø40
 ΤΙΜΗ / PRICE **3,20 €/pc**

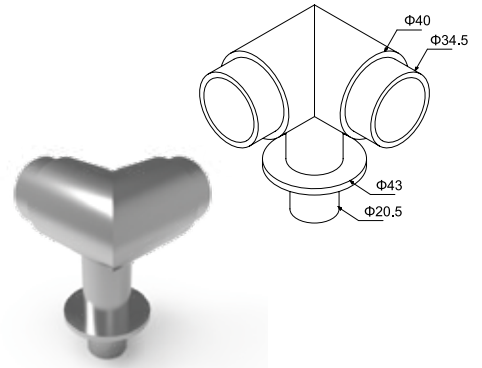

ΚΩΔ. / CODE **4262**
 ΣΥΝΔΕΣΜΟΣ 90° ΓΙΑ ΚΟΥΠΑΣΤΗ Ø40
 CONNECTOR 90° FOR HANDRAIL Ø40
 ΤΙΜΗ / PRICE **11,90 €/pc**

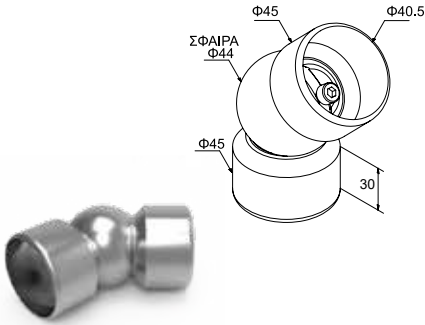

ΚΩΔ. / CODE **4367**
 ΣΥΝΔΕΣΜΟΣ ΜΕΤΑΒΛΗΤΗΣ ΓΩΝΙΑΣ ΚΟΥΠΑΣΤΗΣ Ø40
 ADJUSTABLE CORNER CONNECTOR FOR HANDRAIL Ø40
 ΤΙΜΗ / PRICE **8,30 €/pc**

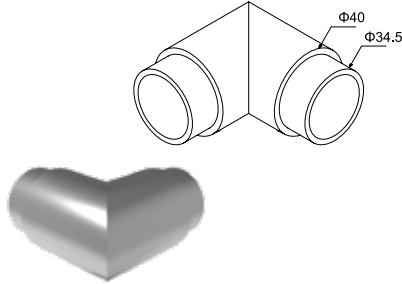

ΚΩΔ. / CODE **4277**
 ΣΥΝΔΕΣΜΟΣ 90° ΓΙΑ ΚΟΥΠΑΣΤΗ Ø40
 CONNECTOR 90° FOR HANDRAIL Ø40
 ΤΙΜΗ / PRICE **6,95 €/pc**

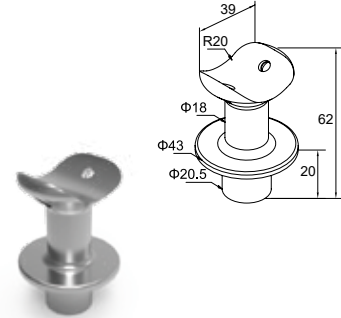

ΚΩΔ. / CODE **4368**
 ΣΤΗΡΙΓΜΑ ΚΟΥΠΑΣΤΗΣ Ø40 ΜΕ ΚΟΛΩΝΑ Ø42
 SUPPORT FOR HANDRAIL Ø40 WITH COLUMN Ø42
 ΤΙΜΗ / PRICE **3,65 €/pc**

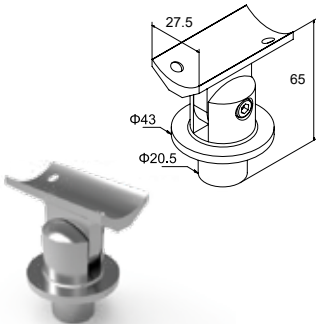

ΚΩΔ. / CODE **4369**
 ΣΤΗΡΙΓΜΑ ΜΕΤΑΒΛΗΤΗΣ ΓΩΝΙΑΣ ΚΟΥΠΑΣΤΗΣ
 Ø40 ΜΕ ΚΟΛΩΝΑ Ø42
 ADJUSTABLE CORNER SUPPORT FOR HANDRAIL
 Ø40 WITH COLUMN Ø42
 ΤΙΜΗ / PRICE **6,40 €/pc**

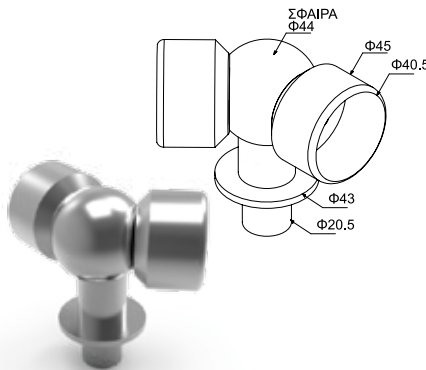

ΚΩΔ. / CODE **4370**
 ΣΥΝΔΕΣΜΟΣ ΜΕΤΑΒΛΗΤΗΣ ΓΩΝΙΑΣ ΚΟΥΠΑΣΤΗΣ Ø40 ΜΕ
 ΚΟΛΩΝΑ Ø42
 ADJUSTABLE CORNER CONNECTOR FOR HANDRAIL Ø40
 WITH COLUMN Ø42
 ΤΙΜΗ / PRICE **19,20 €/pc**

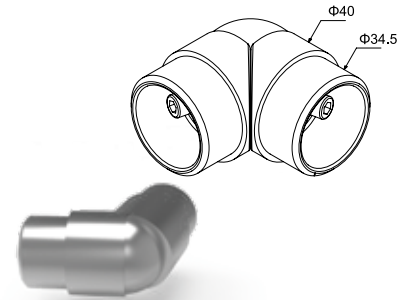

ΚΩΔ. / CODE **4371**
 ΣΥΝΔΕΣΜΟΣ ΜΕΤΑΒΛΗΤΗΣ ΓΩΝΙΑΣ ΚΟΥΠΑΣΤΗΣ Ø40
 ADJUSTABLE CORNER CONNECTOR FOR HANDRAIL Ø40
 ΤΙΜΗ / PRICE **9,55 €/pc**

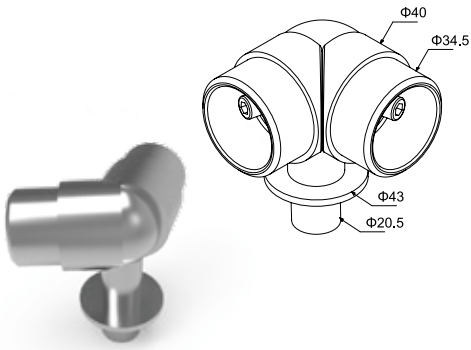

ΚΩΔ. / CODE **4372**
 ΣΥΝΔΕΣΜΟΣ ΜΕΤΑΒΛΗΤΗΣ ΓΩΝΙΑΣ ΚΟΥΠΑΣΤΗΣ Ø40 ΜΕ ΚΟΛΩΝΑ Ø42
 ADJUSTABLE CORNER CONNECTOR FOR HANDRAIL Ø40 WITH COLUMN Ø42
 ΤΙΜΗ / PRICE **15,10 €/pc**

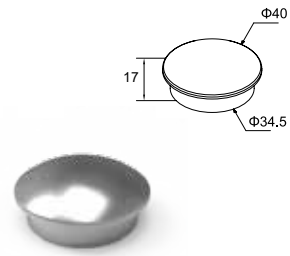

ΚΩΔ. / CODE **4479**
 ΤΑΠΑ ΚΟΥΠΑΣΤΗΣ Ø40
 END CAP FOR HANDRAIL Ø40
 ΤΙΜΗ / PRICE **1,30 €/pc**

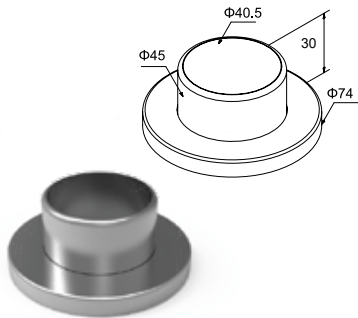

ΑΡΜΟΚΑΛΥΠΤΡΟ ΚΟΥΠΑΣΤΗΣ Ø40
 WALL COVER FOR HANDRAIL Ø40
 ΚΩΔ. / CODE **4520Z**
 ΤΙΜΗ / PRICE **5,45 €/pc**

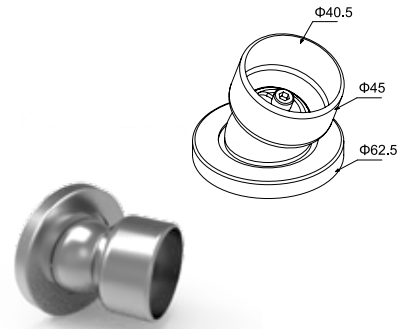

ΚΩΔ. / CODE **4521**
 ΑΡΜΟΚΑΛΥΠΤΡΟ ΚΟΥΠΑΣΤΗΣ Ø40 (ΜΕ ΚΑΠΑΚΙ)
 WALL COVER FOR HANDRAIL Ø40 WITH CAP
 ΤΙΜΗ / PRICE **10,10 €/pc**

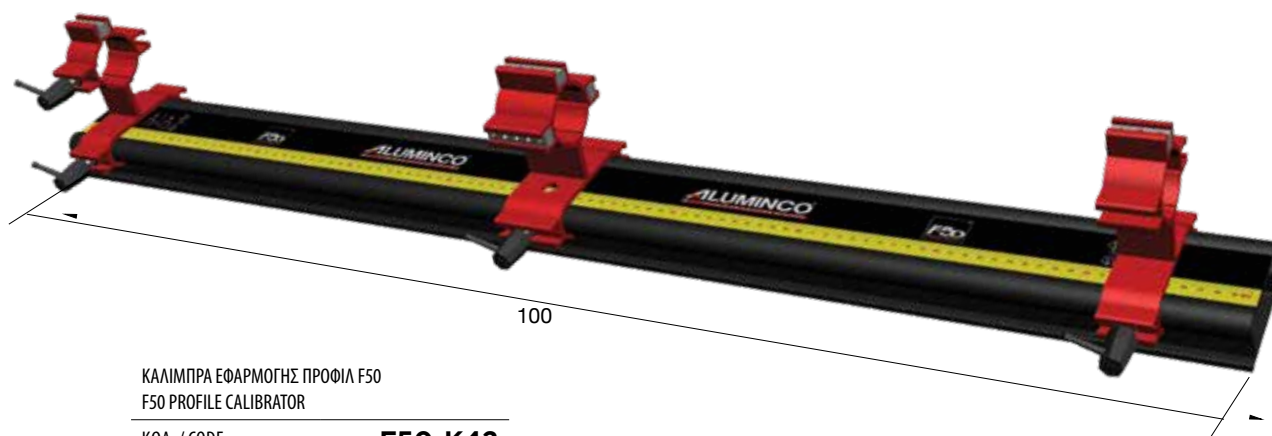

ΚΑΛΙΜΠΡΑ ΕΦΑΡΜΟΓΗΣ ΠΡΟΦΙΛ F50
F50 PROFILE CALIBRATOR

ΚΩΔ. / CODE	F50-K42
ΤΙΜΗ / PRICE	180,00 €/pc



- Σε αναλογία 1:1
- Χρόνος εργασίας 7-8 λεπτά
- Χρόνος αρχικής συγκόλλησης 15-18 λεπτά
- Χρόνος πλήρους συγκόλλησης 3-6 ώρες

- In proportion 1:1
- Working time 7-8 min
- Initial welding time 15-18 min
- Complete welding time 3-6 hours

ΚΟΛΛΑ 9450 50ml
GLUE 9450 50ml

ΚΩΔ. / CODE	6K945
ΤΙΜΗ / PRICE	28,70 €/pc



- Χρόνος σκλήρυνσης 15-20 λεπτά
- Working time 15-20 minutes

ΧΗΜΙΚΟ ΒΥΣΜΑ ΓΙΑ ΕΝΔΟΔΑΠΕΔΙΑ ΣΤΗΡΙΓΜΑΤΑ 4167 ΚΑΙ 4188
RESIN FOR INFLOOR SUPPORTING ACCESSORIES 4167 & 4188

ΚΩΔ. / CODE	UA320.01ELA
ΤΙΜΗ / PRICE	7,03 €/pc



ΑΝΑΜΙΚΤΗΡΑΣ ΚΟΛΛΑΣ 9450 F-50
GLUE MIXER ACCESSORY

ΚΩΔ. / CODE	6KA100
ΤΙΜΗ / PRICE	2,15 €/pc



ΑΝΑΜΙΚΤΗΡΑΣ ΧΗΜΙΚΟΥ ΒΥΣΜΑΤΟΣ UVT410
RESIN MIXER ACCESSORY

ΚΩΔ. / CODE	6KA102
ΤΙΜΗ / PRICE	1,30 €/pc



ΠΙΣΤΟΛΙ ΕΦΑΡΜΟΓΗΣ ΕΠΟΞΙΚΗΣ ΚΟΛΛΑΣ
GLUE APPLICATION PISTOL

ΚΩΔ. / CODE	6KA020
ΤΙΜΗ / PRICE	48,40 €/pc

ΜΠΕΤΟΒΙΔΑ ΦΡΕΖΑΤΗ TORX / TORX CONCRETE SCREW

Κωδικός Code	Διαστάσεις dxL Dimensions dxL	Πρόσθετα χαρακτηριστικά Additional features	Αυτοδιήρτη Selfdrilled	Συσκευασία Package	Τιμή Price
EBM-75G92	7.5x92	ΓΑΛΒΑΝΙΖΕ / ΜΠΕΤΟΝ / ΤΟΥΒΛΟ / TORX GALVANIZED / CONCRETE / BRICK / TORX	ΟΧΙ NO	150/κουτί 150/box	0,10 €/pc
EBM-75G112	7.5x112	ΓΑΛΒΑΝΙΖΕ / ΜΠΕΤΟΝ / ΤΟΥΒΛΟ / TORX GALVANIZED / CONCRETE / BRICK / TORX	ΟΧΙ NO	150/κουτί 150/box	0,12 €/pc

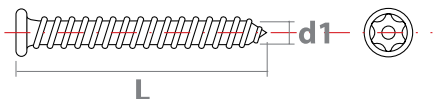

Εργαλείο: ΤΡΥΠΑΝΙ Νο 6 / ΜΥΤΗ TORX T30
Tool: DRILL No 6 / TORX T30

ΥΠΟΧΡΕΩΤΙΚΗ ΧΡΗΣΗ ΡΥΤΙΝΗΣ
MANDATORY USE OF RESIN

Εξαρτήματα / Accessories

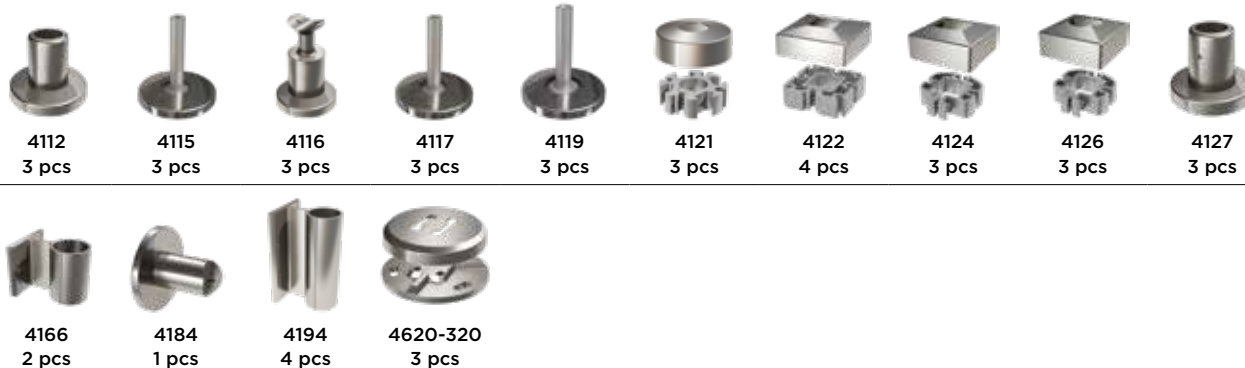

ΤΡΥΠΑΝΟΒΙΔΑ ΦΡΕΖΑΤΗ ΣΤΑΥΡΟΣ / SELF-DRILLED SCREW

Κωδικός Code	Διαστάσεις dxL Dimensions dxL	Πρόσθετα χαρακτηριστικά Additional features	Αυτοδιήρτη Selfdrilled	Συσκευασία Package	Τιμή Price
D7504-P002I	4.2x19 DIN 7504P	INOX / Για αλουμίνιο INOX / For aluminium	ΝΑΙ YES	1000/box	0,05 €/pc

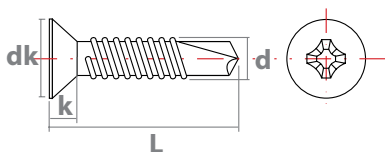

Εργαλείο: ΜΥΤΗ ΣΤΑΥΡΟΣ PH2
Tool: PHILLIPS BIT PH2

Εξαρτήματα / Accessories



ΤΡΥΠΑΝΟΒΙΔΑ ΦΡΕΖΑΤΗ ΣΤΑΥΡΟΣ / SELF-DRILLED SCREW

Κωδικός Code	Διαστάσεις dxL Dimensions dxL	Πρόσθετα χαρακτηριστικά Additional features	Αυτοδιάτρητη Selfdrilled	Συσκευασία Package	Τιμή Price
D7504-P005I	4.8x38 DIN 7504P	INOX / Για αλουμίνιο INOX / For aluminium	ΝΑΙ YES	200 / box	0,13 €/pc

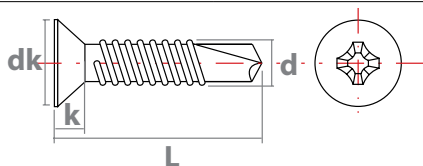

Εργαλείο: ΜΥΘΗ ΣΤΑΥΡΟΣ PH2
Tool: PHILLIPS BIT PH2

Εξαρτήματα / Accessories



ΤΡΥΠΑΝΟΒΙΔΑ ΦΡΕΖΑΤΗ ΣΤΑΥΡΟΣ / SELF-DRILLED SCREW

Κωδικός Code	Διαστάσεις dxL Dimensions dxL	Πρόσθετα χαρακτηριστικά Additional features	Αυτοδιάτρητη Selfdrilled	Συσκευασία Package	Τιμή Price
D7504-P003I	4.2x38 DIN 7504P	INOX / Για αλουμίνιο INOX / For aluminium	ΝΑΙ YES	200 / box	0,07 €/pc

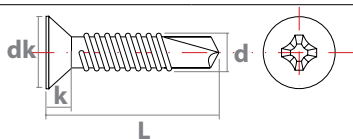

Εργαλείο: ΜΥΘΗ ΣΤΑΥΡΟΣ PH2
Tool: PHILLIPS BIT PH2

Εξαρτήματα / Accessories



ΛΑΜΑΡΙΝΟΒΙΔΑ ΦΡΕΖΑΤΗ ΣΤΑΥΡΟΣ-ΟΥΠΑΤ / TAPPING SCREW-PLASTIC PLUG

Κωδικός Code	Διαστάσεις dxL Dimensions dxL	Πρόσθετα χαρακτηριστικά Additional features	Αυτοδιαάτρητη Selfdaarilled	Συσκευασία Package	Τιμή Price
D7982-001I	4.8x38 DIN 7982	INOX / Για πλαστικό ΟΥΠΑΤ Νο6 INOX / For plastic PLUG No6	ΝΑΙ YES	200 / box	0,07 €/pc

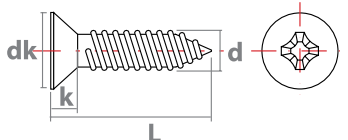

Εργαλείο: ΜΥΤΗ ΣΤΑΥΡΟΣ PH2
Tool: PHILLIPS BIT PH2

Κωδικός Code	Διαστάσεις dxL Dimensions dxL	Πρόσθετα χαρακτηριστικά Additional features	Αυτοδιαάτρητη Selfdaarilled	Συσκευασία Package	Τιμή Price
EB01P-0630X	No 6x30	ΠΛΑΣΤΙΚΟ / 4.8x38 PLASTIC / 4.8x38	-	500 / box	0,03 €/pc

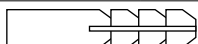

Εργαλείο: ΤΡΥΠΑΝΙ No 6
Tool: DRILL No 6

Εξαρτήματα / Accessories



ΒΙΔΑ ALLEN - ΕΚΤΟΝΟΥΜΕΝΟ ΜΕΤΑΛΛΙΚΟ ΟΥΠΑΤ / ALLEN SCREW - METALLIC ANCHOR

Κωδικός Code	Διαστάσεις dxL Dimensions dxL	Πρόσθετα χαρακτηριστικά Additional features	Αυτοδιαάτρητη Selfdaarilled	Συσκευασία Package	Τιμή Price
EB912-0100I	M10x100 DIN 912	INOX / ΜΠΕΤΟΝ / Για αγκύριο M10 INOX / CONCRETE / For metallic anchor M10	ΟΧΙ NO	100 / box	0,97 €/pc
EB912-0120I	M10x120 DIN 912	INOX / ΜΑΡΜΑΡΟ / Για αγκύριο M10 INOX / MARBLE / For metallic anchor M10	ΟΧΙ NO	100 / box	1,61 €/pc
EB912-1070I	M10x70 DIN 912	INOX / ΜΑΡΜΑΡΟ / Για αγκύριο M10 INOX / MARBLE / For metallic anchor M10	ΟΧΙ NO	50 / box	0,63 €/pc

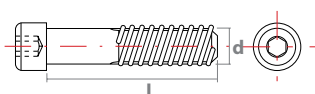

Εργαλείο: ΤΡΥΠΑΝΙ No 8
Tool: DRILL No 8

Κωδικός Code	Διαστάσεις dxL Dimensions dxL	Πρόσθετα χαρακτηριστικά Additional features	Αυτοδιαάτρητη Selfdaarilled	Συσκευασία Package	Τιμή Price
EB01M-1040G	M10x40	ΓΑΛΒΑΝΙΖΕ / Για M10x100 & M10x120 GALVANIZED / For M10x100 & M10x120	-	50 / box	0,60 €/pc

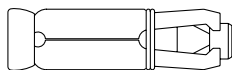

Εργαλείο: ΤΡΥΠΑΝΙ No 10
Tool: DRILL No 10

Εξαρτήματα / Accessories



4139
2 pcs













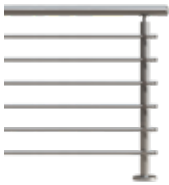







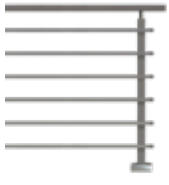



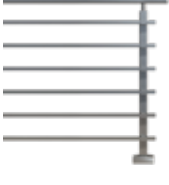
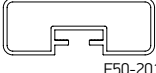



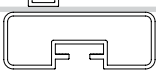

4142
2 pcs





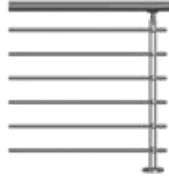







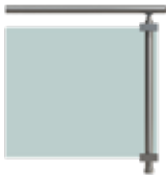
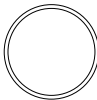





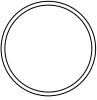











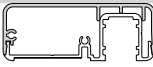

4143
2 pcs

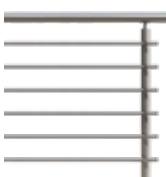

4144
2 pcs

Τύπος Type	Σχέδιο Shape	Βασικά προφίλ Basic profile	Δείγμα Sample
ACCORD		 F50-100  F50-200  F50-300	F50-1001 50x50: 30 €/pc 100x100: 45 €/pc
ACCORD QUATTRO		 F50-100  F50-200  F50-302	F50-1003 50x50: 30 €/pc 100x100: 45 €/pc
ACCORD SQUARE		 F50-201  F50-102  F50-122  F50-302	F50-1004 50x50: 30 €/pc 100x100: 45 €/pc
ACCORD X SQUARE		 F50-201  F50-102  F50-122  F50-302	F50-1007 50x50: 30 €/pc 100x100: 45 €/pc
ACCORD SQUARE Q		 F50-201  F50-102  F50-122  F50-300	F50-1005 50x50: 30 €/pc 100x100: 45 €/pc
ACCORD TUBULAR		 F50-201  F50-102  F50-122  F50-304	F50-1006 50x50: 30 €/pc 100x100: 45 €/pc
ACCORD BLADE		 F50-200  F50-300  F50-108	F50-1002 50x50: 30 €/pc 100x100: 45 €/pc

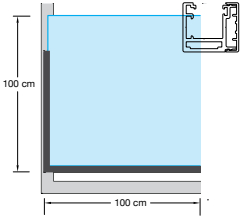
Τύπος Type	Σχέδιο Shape	Βασικά προφίλ Basic profile	Δείγμα Sample
HORIZON		 F50-100 F50-200	F50-1008 50x50: 30 €/pc 100x100: 45 €/pc
HORIZON X-RAIL		 F50-100 F50-200 F50-300	F50-1015 50x50: 30 €/pc 100x100: 45 €/pc
HORIZON SQUARE X-RAIL		 F50-201 F50-102 F50-122 F50-300	F50-1016 50x50: 30 €/pc 100x100: 45 €/pc
HORIZON U-RAIL		 F50-100 F50-200 F50-305	F50-1014 50x50: 30 €/pc 100x100: 45 €/pc
HORIZON FRAME		 F50-203 F50-223 F50-106 F50-319 F50-3K19	F50-1010 50x50: 30 €/pc 100x100: 45 €/pc
HORIZON H-RINGS		 F50-200 F50-101 F50-121	F50-1011 50x50: 30 €/pc 100x100: 45 €/pc
HORIZON BLADE		 F50-200 F50-108	F50-1009 50x50: 30 €/pc 100x100: 45 €/pc
HORIZON QUATTRO		 F50-201 F50-102 F50-122	F50-1013 50x50: 30 €/pc 100x100: 45 €/pc

Τύπος Type	Σχέδιο Shape	Βασικά προφίλ Basic profile	Δείγμα Sample
HORIZON MAX		 F50-200  F50-103  F50-123	F50-1012 50x50: 30 €/pc 100x100: 45 €/pc
VERTICAL		 F50-100  F50-200	F50-1017 50x50: 30 €/pc 100x100: 45 €/pc
VERTICAL-R		 F50-200  F50-200  F50-306K  F50-306P	F50-1020 50x50: 30 €/pc 100x100: 45 €/pc
VERTICAL-D		 F50-201  F50-102  F50-122  F50-307  F50-327  F50-308	F50-1018 50x50: 30 €/pc 100x100: 45 €/pc
VERTICAL-Q		 F50-203  F50-223  F50-106  F50-319  F50-3K19  F50-311	F50-1019 50x50: 30 €/pc 100x100: 45 €/pc
SLIM LINE		 F50-100  F50-300  F50-209	F50-1021 50x50: 30 €/pc 100x100: 45 €/pc
CLASSIC EUROPEAN		 F50-319  F50-3K19	F50-1022 50x50: 30€/τεμ. pc 100x100: 45€/τεμ. pc



320 11 Inofita Viotia, Greece
T. +30 22620 47000 F. +30 22620 47090
www.aluminco.com