

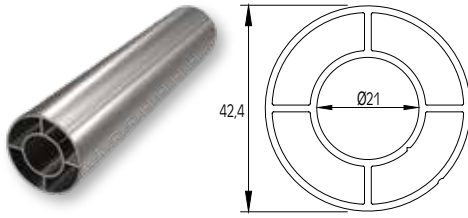

F50
RAILING SYSTEM

Pricelist / Liste de prix





SUPPORT COLUMN Ø42
POTEAU Ø42

CODE	F50-100
WEIGHT / POIDS	1025 gr/m
PRICE / PRIX	7,00 €/Kg



SUPPORT COLUMN Ø50
POTEAU Ø50

CODE	F50-101
WEIGHT / POIDS	1915 gr/m
PRICE / PRIX	7,00 €/Kg

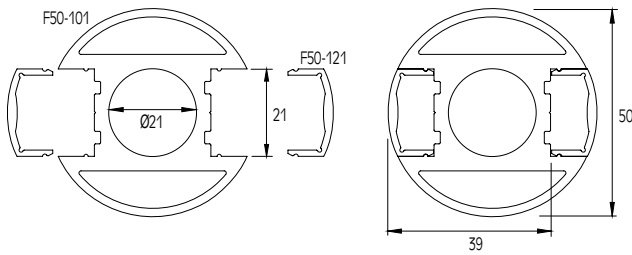

COVER FOR F50-101 COLUMN
CAPUCHON DE POTEAU F50-101

CODE	F50-121
WEIGHT / POIDS	152 gr/m
PRICE / PRIX	7,00 €/Kg



SUPPORT COLUMN 40x40
POTEAU 40x40

CODE	F50-102
WEIGHT / POIDS	1153 gr/m
PRICE / PRIX	7,00 €/Kg

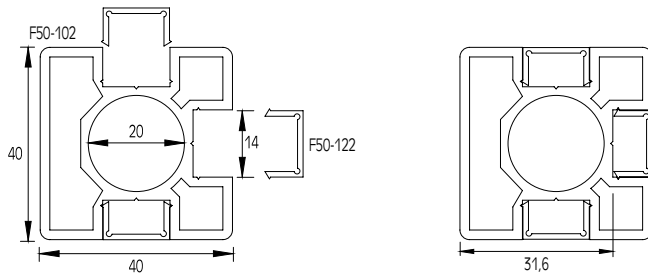

COVER FOR F50-102 COLUMN
CAPUCHON DE POTEAU F50-102

CODE	F50-122
WEIGHT / POIDS	86 gr/m
PRICE / PRIX	7,00 €/Kg



SUPPORT COLUMN Ø42
POTEAU Ø42

CODE	F50-103
WEIGHT / POIDS	980 gr/m
PRICE / PRIX	7,00 €/Kg

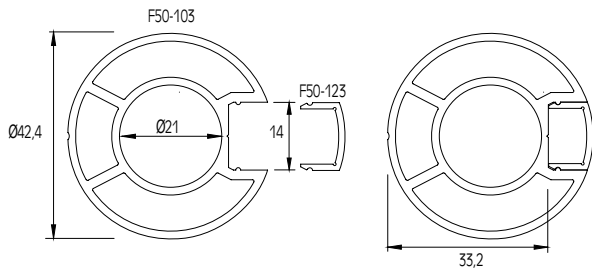

COVER FOR F50-103 COLUMN
CAPUCHON DE POTEAU F50-103

CODE	F50-123
WEIGHT / POIDS	90 gr/m
PRICE / PRIX	7,00 €/Kg

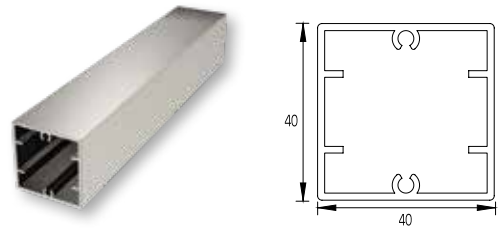

SUPPORT COLUMN 40x40
POTEAU 40x40

CODE	F50-106
WEIGHT / POIDS	794 gr/m
PRICE / PRIX	7,00 €/Kg

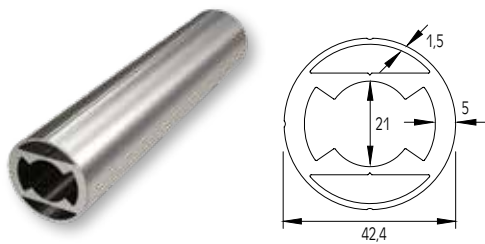

SUPPORT COLUMN Ø42 (HEAVY-DUTY)
POTEAU Ø42 ROBUSTE

CODE	F50-107
WEIGHT / POIDS	1647 gr/m
PRICE / PRIX	7,00 €/Kg

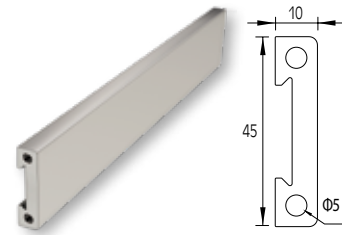

BLADE COLUMN
POTEAU BLADE

CODE	F50-108
WEIGHT / POIDS	851 gr/m
PRICE / PRIX	7,00 €/Kg

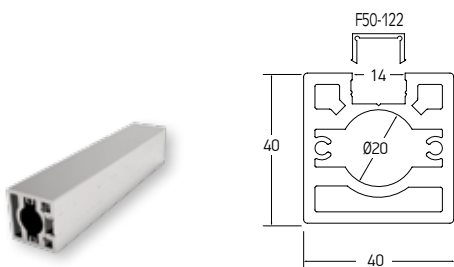

SUPPORT COLUMN 40x40
POTEAU 40x40

CODE	F50-109
WEIGHT / POIDS	1968 gr/m
PRICE / PRIX	7,00 €/Kg

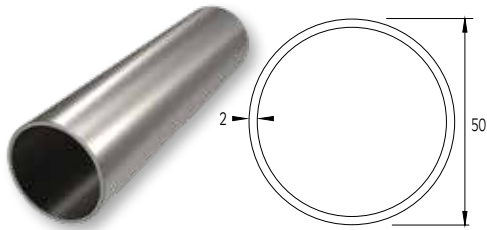

HANDRAIL Ø50
MAIN COURANTE Ø50

CODE	F50-200
WEIGHT / POIDS	815 gr/m
PRICE / PRIX	7,00 €/Kg

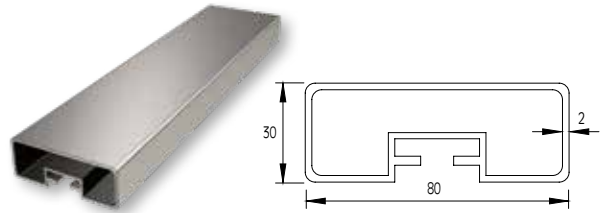

HANDRAIL 30x80
MAIN COURANTE 30x80

CODE	F50-201
WEIGHT / POIDS	1350 gr/m
PRICE / PRIX	7,00 €/Kg



DIVIDABLE HANDRAIL 30x80
MAIN COURANTE 30x80 (DIVISE)

CODE	F50-203
WEIGHT / POIDS	740 gr/m
PRICE / PRIX	7,00 €/Kg

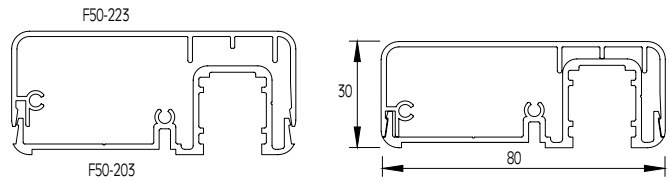

COVER FOR DIVIDABLE HANDRAIL F50-203
CAPUCHON DE MAIN COURANTE F50-203 (DIVISE)

CODE	F50-223
WEIGHT / POIDS	610 gr/m
PRICE / PRIX	7,00 €/Kg

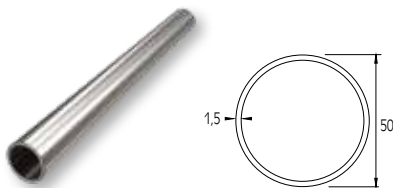

HANDRAIL Ø50
MAIN COURANTE Ø50

CODE	F50-205
WEIGHT / POIDS	617 gr/m
PRICE / PRIX	7,00 €/Kg

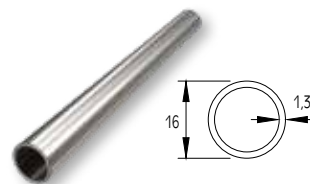

PROFILE Ø16x1.3
PROFIL Ø16x1.3

CODE	F50-300
WEIGHT / POIDS	162 gr/m
PRICE / PRIX	7,00 €/Kg

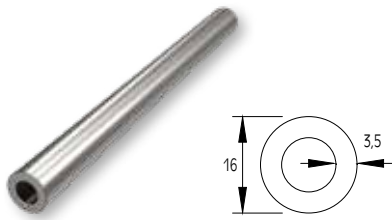

PROFILE Ø16x3.5
PROFIL Ø16x3.5

CODE	F50-301
WEIGHT / POIDS	370 gr/m
PRICE / PRIX	7,00 €/Kg

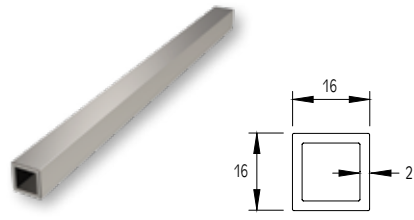

SQUARE 16x16x2
CARE 16x16x2

CODE	F50-302
WEIGHT / POIDS	302 gr/m
PRICE / PRIX	7,00 €/Kg



PROFILE Ø16 WITH SCREW HOLE
PROFIL Ø16 AVEC TROU DE VIS

CODE	F50-303
WEIGHT / POIDS	262 gr/m
PRICE / PRIX	7,00 €/Kg

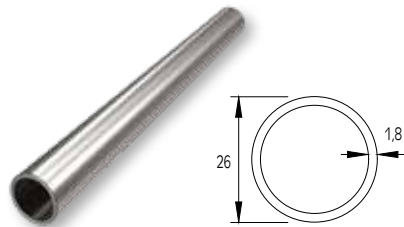

PROFILE Ø26x1.8
PROFILE Ø26x1.8

CODE	F50-304
WEIGHT / POIDS	370 gr/m
PRICE / PRIX	7,00 €/Kg

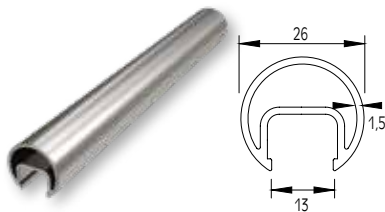

GUIDE FOR GLASS
GUIDAGE DE VERRE

CODE	F50-305
WEIGHT / POIDS	394 gr/m
PRICE / PRIX	7,00 €/Kg

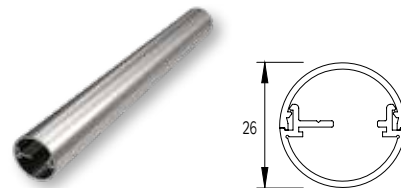

PERFORATED GUIDE Ø26
GUIDAGE PERFORE Ø26

CODE	F50-306
WEIGHT / POIDS	368 gr/m
PRICE / PRIX	7,00 €/Kg

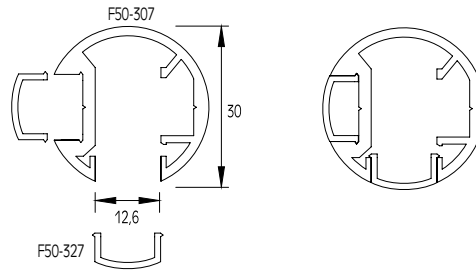

GUIDE Ø30
GUIDAGE Ø30

CODE	F50-307
WEIGHT / POIDS	442 gr/m
PRICE / PRIX	7,00 €/Kg

COVER FOR GUIDE Ø30
CAPUCHON DE GUIDAGE Ø30

CODE	F50-327
WEIGHT / POIDS	68 gr/m
PRICE / PRIX	7,00 €/Kg

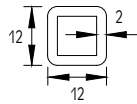

PROFILE 12x12x2
PROFIL 12x12x2

CODE	F50-308
WEIGHT / POIDS	215 gr/m
PRICE / PRIX	7,00 €/Kg

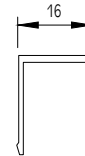

COVER FOR F50-319 GUIDE AND F50-203 HANDRAIL
CAPUCHON DE GUIDAGE F50-310 & MAIN COURANTE F50-203

CODE	F50-311
WEIGHT / POIDS	176 gr/m
PRICE / PRIX	7,00 €/Kg

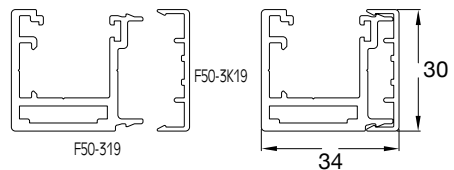

GUIDE FOR GLASS 10-12mm
GUIDAGE DE VERRE 10-12mm

CODE	F50-319
WEIGHT / POIDS	687 gr/m
PRICE / PRIX	7,00 €/Kg

COVER FOR F50-319 GUIDE
CAPUCHON DE GUIDAGE F50-319

CODE	F50-3K19
WEIGHT / POIDS	160 gr/m
PRICE / PRIX	7,00 €/Kg

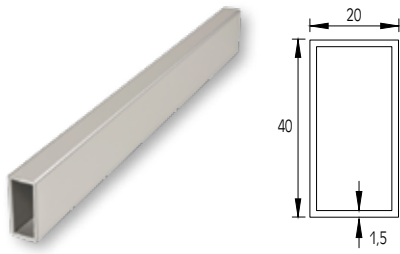

PROFILE 40x20
PROFIL 40x20x1.5

CODE	59-009
WEIGHT / POIDS	462 gr/m

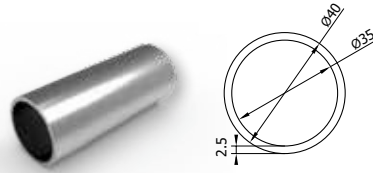

HANDRAIL Ø40
MAIN COURANTE Ø40

CODE	F50-209
WEIGHT / POIDS	800 gr/m
PRICE / PRIX	7,00 €/Kg

COLORS PRICELIST

CATEGORY A	0,60 €
CATEGORY A2	0,75 €
CATEGORY SMART	0,85 €
CATEGORY B	0,90 €
CATEGORY C	1,00 €
CATEGORY D	1,10 €
CATEGORY E	1,40 €
CATEGORY F	1,60 €
WOOD COLORS	2,95 €
ANODISE A-432 FOR RAILING PROFILE F-50	1,90 €
ANODISE A-432 FOR RAILING PROFILE Crystal Line	1,90 €

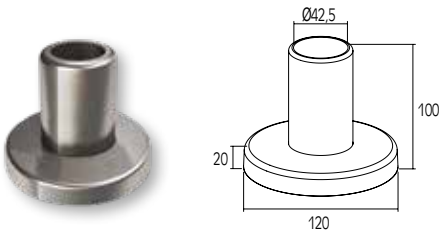

EXTERNAL SUPPORT FOOT FOR Ø42 COLUMN
SABOT EXTERIEUR DE POTEAU Ø42

CODE	4112
PRICE / PRIX	12,75 €/pc

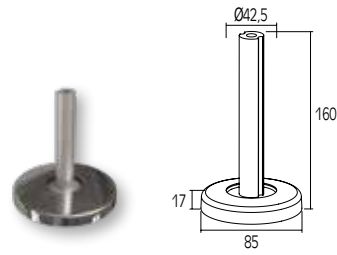

SUPPORT FOOT FOR Ø42 COLUMN
SABOT DE POTEAU Ø42

CODE	4115
PRICE / PRIX	5,60 €/pc

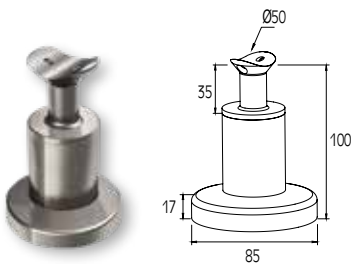

SUPPORT FOR F50-200 HANDRAIL
FIXATION DE MAIN COURANTE F50-200

CODE	4116
PRICE / PRIX	8,50 €/pc

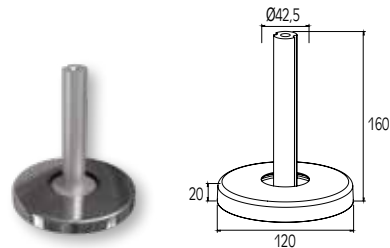

SUPPORT FOOT FOR Ø42 COLUMN
SABOT DE POTEAU Ø42

CODE	4117
PRICE / PRIX	9,00 €/pc

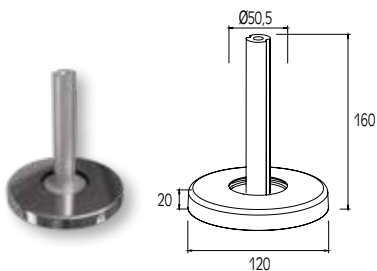

SUPPORT FOOT FOR Ø50 COLUMN
SABOT DE POTEAU Ø50

CODE	4119
PRICE / PRIX	9,00 €/pc

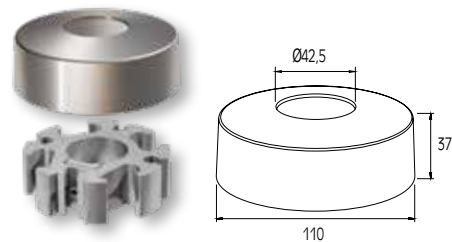

SUPPORT FOOT FOR Ø42 COLUMN
SABOT DE POTEAU Ø42

CODE	4121
PRICE / PRIX	7,50 €/pc

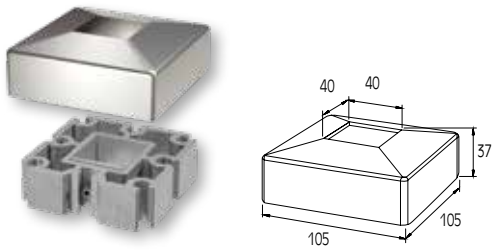

SUPPORT FOOT FOR 40x40 COLUMN
SABOT DE POTEAU 40x40

CODE	4122
PRICE / PRIX	8,35 €/pc

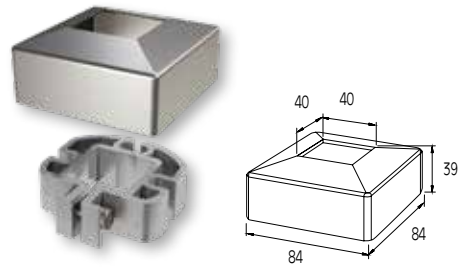

SUPPORT FOOT FOR 40x40 COLUMN
SABOT DE POTEAU 40x40

CODE	4124
PRICE / PRIX	8,00 €/pc

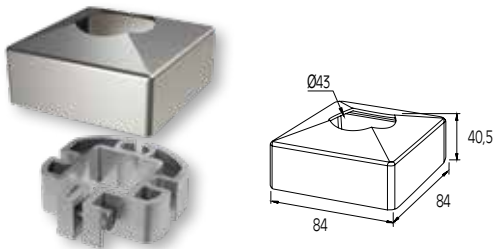

SUPPORT FOOT FOR Ø42 COLUMN
SABOT DE POTEAU Ø42

CODE	4126
PRICE / PRIX	9,95 €/pc

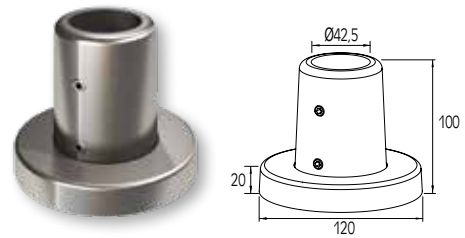

HEAVY DUTY SUPPORT FOOT FOR Ø42 COLUMN
SABOT DE POTEAU Ø42 ROBUSTE

CODE	4127
PRICE / PRIX	27,70 €/pc

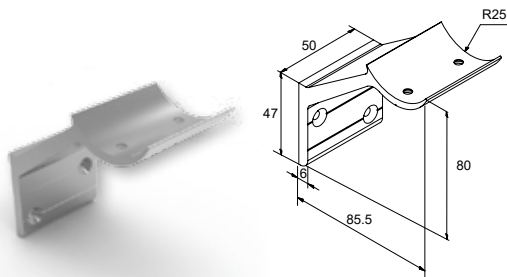

FIXED WALL SUPPORT FOR F50-200 HANDRAIL
FIXATION MURALE DE MAIN COURANTE F50-200

CODE	4134
PRICE / PRIX	3,40 €/pc

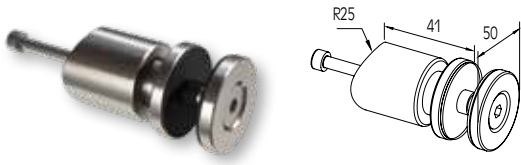

SINGLE GLASS SUPPORT 8-10mm FOR F50-101 COLUMN
FIXATION DE VERRE 8-10mm DE POTEAU F50-101

CODE	4137
PRICE / PRIX	10,20 €/pc

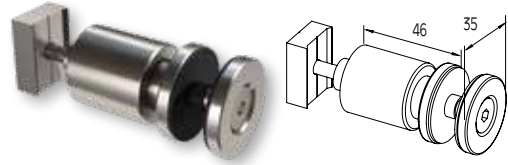

SINGLE GLASS SUPPORT 8-10mm FOR BLADE COLUMN
FIXATION DE VERRE 8-10mm DE POTEAU BLADE

CODE	4138
PRICE / PRIX	11,60 €/pc

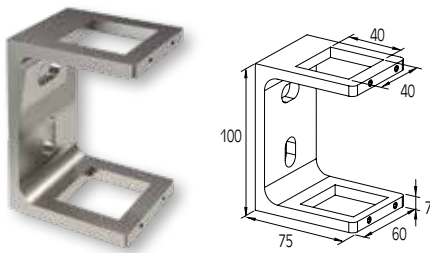

EXTERNAL SUPPORT FOR 40x40 COLUMN
FIXATION EXTERIEURE DE POTEAU 40x40

CODE	4139
PRICE / PRIX	13,10 €/pc

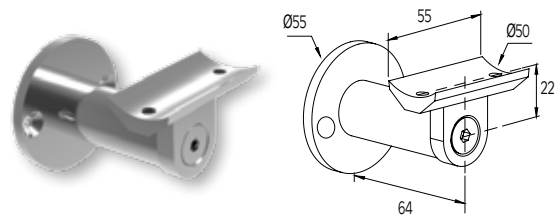

WALL SUPPORT FOR F50-200 HANDRAIL
FIXATION MURALE DE MAIN COURANTE F50-200

CODE	4140
PRICE / PRIX	6,55 €/pc

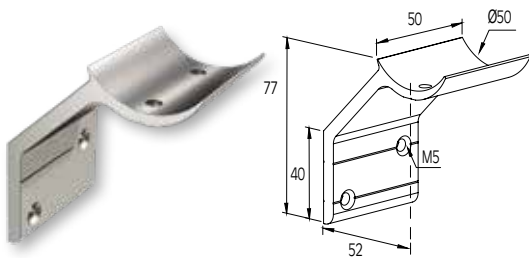

FIXED WALL SUPPORT FOR F50-200 HANDRAIL
FIXATION MURALE DE MAIN COURANTE F50-200

CODE	4141
PRICE / PRIX	2,75 €/pc

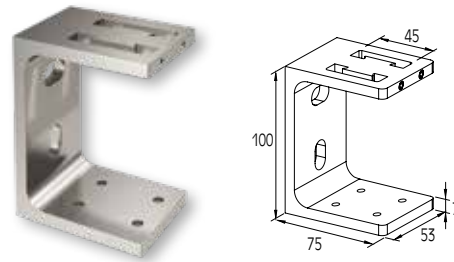

EXTERNAL SUPPORT FOR BLADE COLUMN
FIXATION EXTERIEURE DE POTEAU BLADE

CODE	4142
PRICE / PRIX	13,10 €/pc

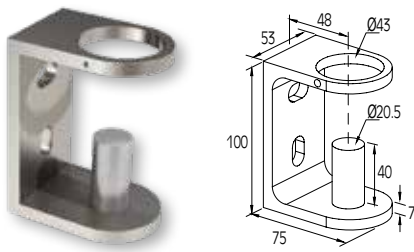

EXTERNAL SUPPORT FOR F50-100/103 COLUMN
FIXATION MURALE DE POTEAU F50-100/103

CODE **4143**
PRICE / PRIX **9,50 €/pc**

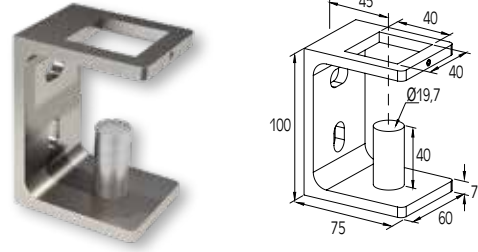

EXTERNAL SUPPORT FOR F50-102 COLUMN
FIXATION MURALE DE POTEAU F50-102

CODE **4144**
PRICE / PRIX **13,10 €/pc**

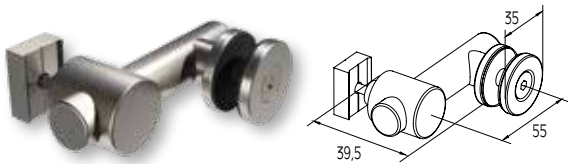

SINGLE GLASS SUPPORT 8-10mm FOR BLADE COLUMN
FIXATION DE VERRE 8-10mm DE POTEAU BLADE

CODE **4146**
PRICE / PRIX **14,60 €/pc**

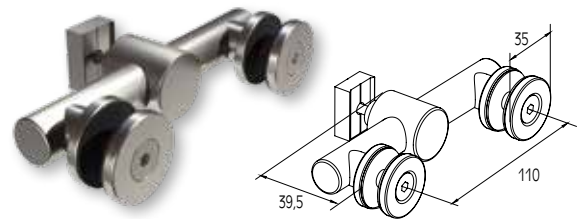

SINGLE GLASS SUPPORT 8-10mm FOR BLADE COLUMN
DOUBLE FIXATION DE VERRE 8-10mm DE POTEAU BLADE

CODE **4147**
PRICE / PRIX **20,20 €/pc**

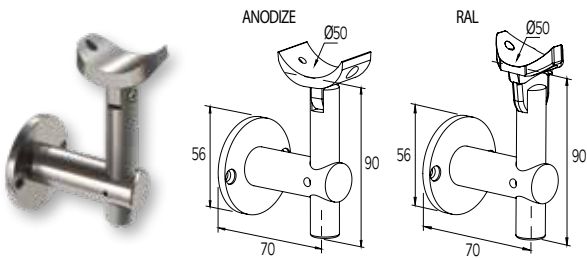

SUPPORT FOR F50-200 HANDRAIL
FIXATION MURALE DE MAIN COURANTE F50-200

CODE **4165**
PRICE / PRIX **9,90 €/pc**

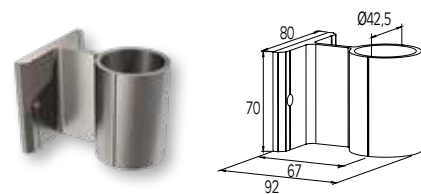

EXTERNAL SUPPORT FOR Ø42 COLUMN
FIXATION EXTERIEURE DE POTEAU Ø42

CODE **4166**
PRICE / PRIX **6,80 €/pc**

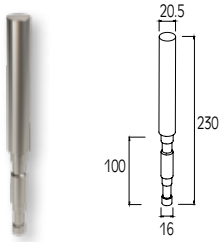

INFLOOR SUPPORT FOR Ø42 COLUMN
FIXATION ENCASTRE DE POTEAU Ø42

CODE	4167
PRICE / PRIX	1,90 €/pc

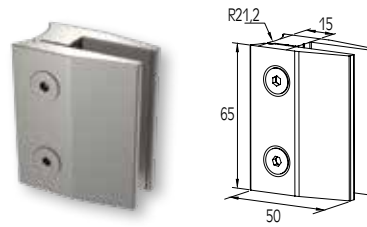

GLASS SUPPORT 8-10mm
FIXATION DE VERRE 8-10mm

CODE	4168
PRICE / PRIX	4,75 €/pc

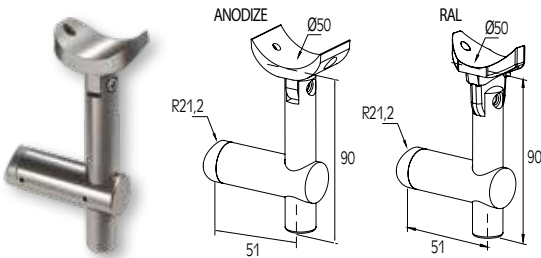

EXTERNAL SUPPORT FOR HANDRAIL Ø50 WITH COLUMN Ø42
FIXATION EXTERIEURE DE MAIN COURANTE Ø50 AVEC POTEAU Ø42

CODE	4169
PRICE / PRIX	6,65 €/pc

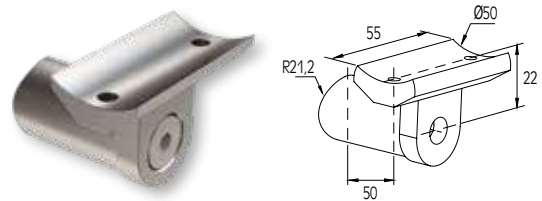

EXTERNAL SUPPORT FOR HANDRAIL Ø50 WITH COLUMN Ø42
FIXATION EXTERIEURE DE MAIN COURANTE Ø50 AVEC POTEAU Ø42

CODE	4169B
PRICE / PRIX	5,10 €/pc

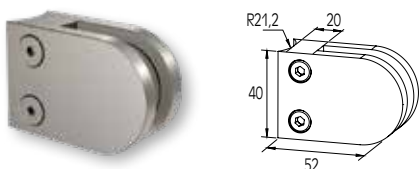

INOX GLASS SUPPORT 6-8mm INOX
FIXATION DE VERRE 6-8mm INOX

CODE	4172
PRICE / PRIX INOX 304	5,90 €/pc
PRICE / PRIX INOX 316	12,85 €/pc

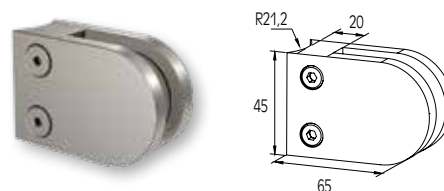

GLASS SUPPORT 8-10mm INOX
FIXATION DE VERRE 8-10mm INOX

CODE	4173
PRICE / PRIX INOX 304	16,20 €/pc
PRICE / PRIX INOX 316	18,10 €/pc

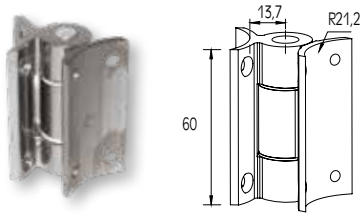

HINGE FOR F50-100 COLUMN
CHARNIERE DE POTEAU F50-100

CODE	4177
PRICE / PRIX	5,90 €/pc

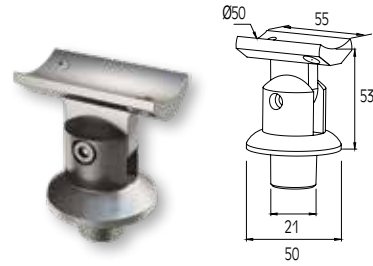

SUPPORT FOR HANDRAIL F50-200 WITH COLUMN F50-101
FIXATION DE MAIN COURANTE F50-200 AVEC POTEAU F50-101

CODE	4179
PRICE / PRIX	7,95 €/pc

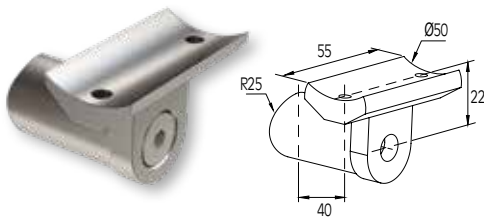

EXTERNAL SUPPORT FOR HANDRAIL F50-200 WITH COLUMN F50-101
FIXATION EXTERIEURE DE MAIN COURANTE F50-200 AVEC POTEAU F50-101

CODE	4180
PRICE / PRIX	6,35 €/pc

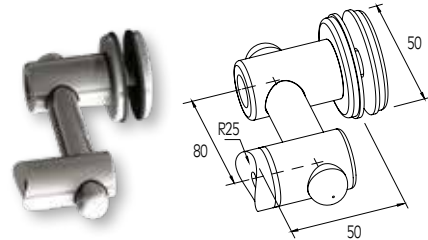

SINGLE GLASS SUPPORT 8-10mm FOR Ø50 COLUMN
FIXATION DE VERRE 8-10mm DE POTEAU Ø50

CODE	4181
PRICE / PRIX	19,30 €/pc

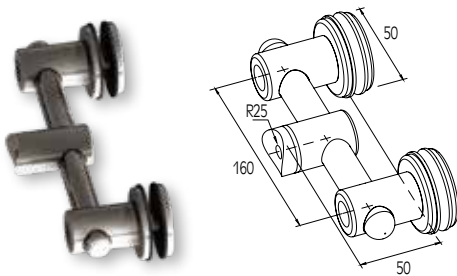

SINGLE GLASS SUPPORT 8-10mm FOR Ø50 COLUMN
DOUBLE FIXATION DE VERRE 8-10mm DE POTEAU Ø50

CODE	4182
PRICE / PRIX	32,00 €/pc

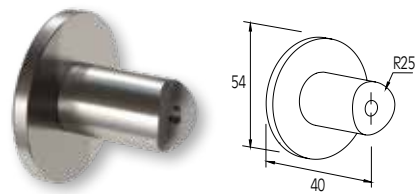

EXTERNAL SUPPORT FOR F50-101 COLUMN
FIXATION EXTERIEURE DE POTEAU F50-101

CODE	4184
PRICE / PRIX	3,40 €/pc

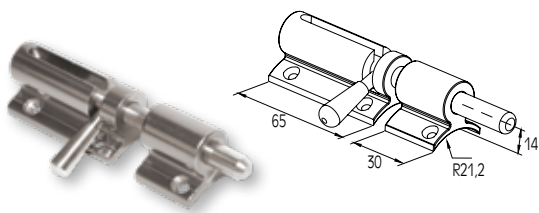

BOLT FOR F50-100 COLUMN
VERROU DE POTEAU F50-101

CODE	4186
PRICE / PRIX	7,45 €/pc

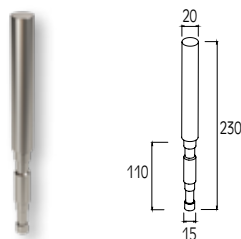

INFLOOR SUPPORT FOR F50-102 COLUMN
FIXATION ENCASTRE DE POTEAU F50-102

CODE	4188
PRICE / PRIX	2,55 €/pc

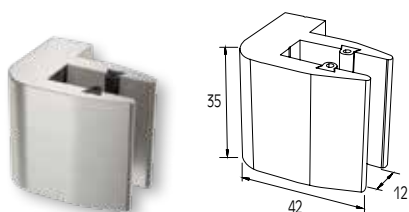

EXTERNAL SINGLE GLASS SUPPORT 8-10mm FOR F50-102 COLUMN
SINGLE FIXATION EXTERIEURE DE VERRE 8-10mm DE POTEAU F50-102

CODE	4189
PRICE / PRIX	3,45 €/pc

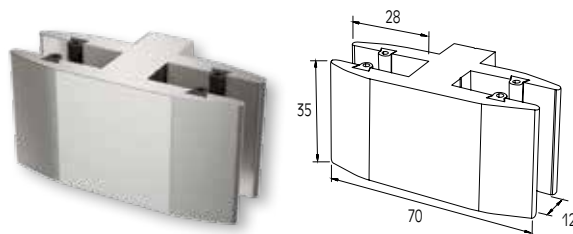

EXTERNAL DOUBLE GLASS SUPPORT 8-10mm FOR F50-102 COLUMN
DOUBLE FIXATION EXTERIEURE DE VERRE 8-10mm DE POTEAU F50-102

CODE	4190
PRICE / PRIX	5,30 €/pc

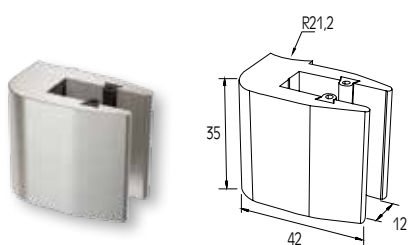

SINGLE GLASS SUPPORT 8-10mm FOR F50-103 COLUMN
SINGLE FIXATION EXTERIEURE DE VERRE 8-10mm DE POTEAU F50-103

CODE	4191
PRICE / PRIX	3,85 €/pc

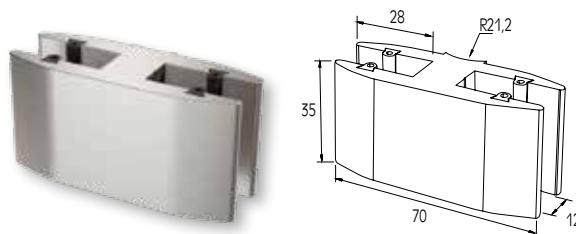

DOUBLE GLASS SUPPORT 8-10mm FOR F50-103 COLUMN
DOUBLE FIXATION EXTERIEURE DE VERRE 8-10mm DE POTEAU F50-103

CODE	4192
PRICE / PRIX	5,70 €/pc

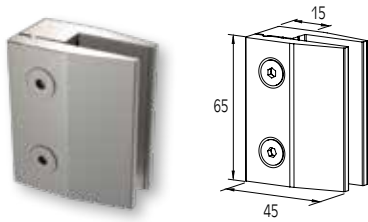

SINGLE GLASS SUPPORT 8-10mm FOR F50-102/106 COLUMN
SINGLE FIXATION EXTERIEURE DE VERRE 8-10mm DE POTEAU F50-102/106

CODE	4193
PRICE / PRIX	4,95 €/pc

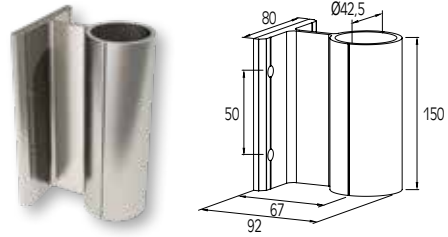

EXTERNAL WALL SUPPORT FOR COLUMN Ø42
FIXATION MURALE EXTERIEURE DE POTEAU Ø42

CODE	4194
PRICE / PRIX	13,10 €/pc

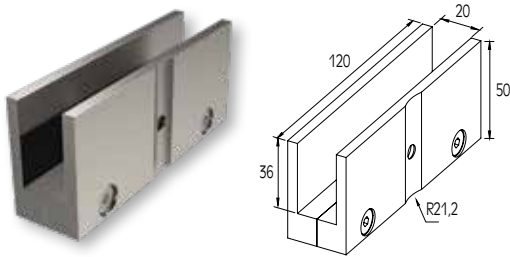

DOUBLE GLASS SUPPORT 19-22mm
FIXATION DOUBLE DE VERRE 19-22mm

CODE	4195
PRICE / PRIX	10,50 €/pc

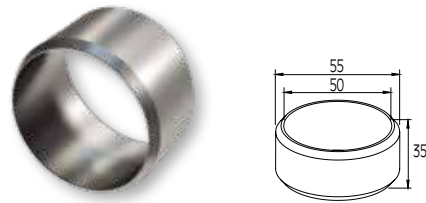

CONNECTOR FOR HANDRAIL Ø50
JONCTION DE MAIN COURANTE Ø50

CODE	4218
PRICE / PRIX	1,25 €/pc

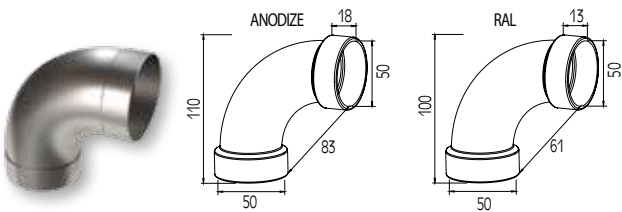

CONNECTOR FOR HANDRAIL Ø50
JONCTION 90° DE MAIN COURANTE Ø50

CODE	4219
PRICE / PRIX	5,40 €/pc

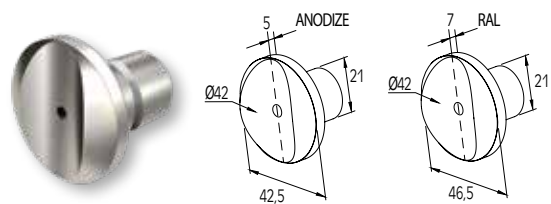

CONNECTOR FOR COLUMN WITH COLUMN F50-100
JONCTION DE POTEAU AVEC POTEAU F50-100

CODE	4224
PRICE / PRIX	3,95 €/pc

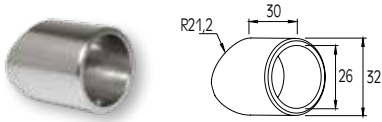

CONNECTOR FOR F50-100 COLUMN WITH PROFILE Ø26
JONCTION DE POTEAU F50-100 AVEC PROFIL Ø26

CODE **4225**
PRICE / PRIX **2,05 €/pc**

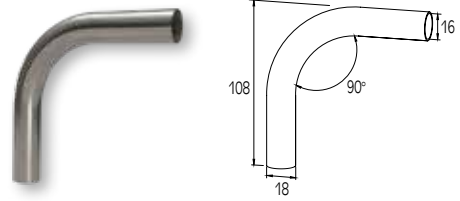

CONNECTOR 90° FOR PROFILE Ø16
JONCTION 90° DE PROFIL Ø16

CODE **4228**
PRICE / PRIX **1,40 €/pc**

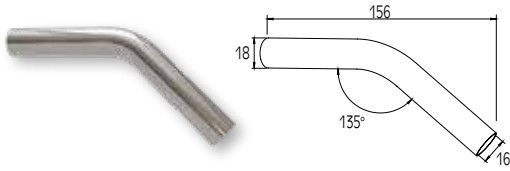

CONNECTOR 135° FOR PROFILE Ø16
JONCTION 135° DE PROFIL Ø16

CODE **4229**
PRICE / PRIX **1,40 €/pc**

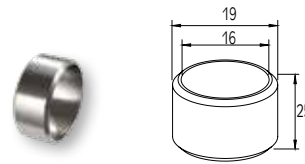

CONNECTOR FOR PROFILE Ø16 (STRAIGHT)
JONCTION DE PROFIL Ø16 (DROIT)

CODE **4230**
PRICE / PRIX **0,85 €/pc**

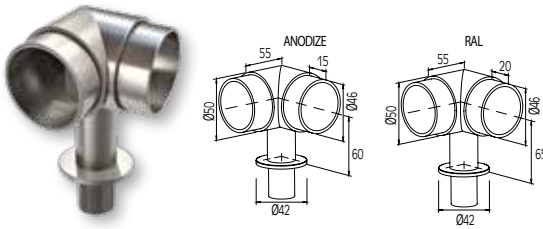

CONNECTOR 90° FOR HANDRAIL Ø50
JONCTION 90° DE MAIN COURANTE Ø50

CODE **4231**
PRICE / PRIX **11,10 €/pc**

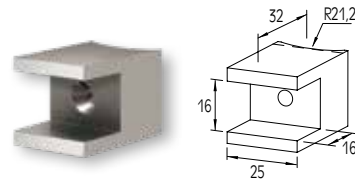

CONNECTOR FOR F50-100 COLUMN WITH F50-302 PROFILE
JONCTION DE POTEAU F50-100 AVEC PROFIL F50-302

CODE **4232**
PRICE / PRIX **3,85 €/pc**

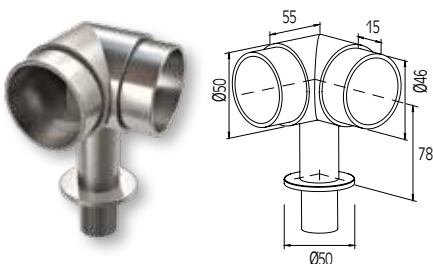

CONNECTOR 90° FOR HANDRAIL Ø50
JONCTION 90° DE MAIN COURANTE Ø50

CODE **4235**
PRICE / PRIX **11,40 €/pc**

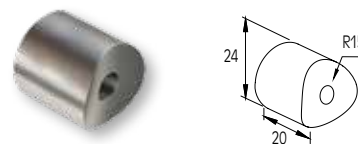

CONNECTOR FOR F50-307 GUIDE WITH F50-102 COLUMN
JONCTION DE F50-307 GUIDAGE AVEC POTEAU F50-102

CODE **4240**
PRICE / PRIX **1,70 €/pc**

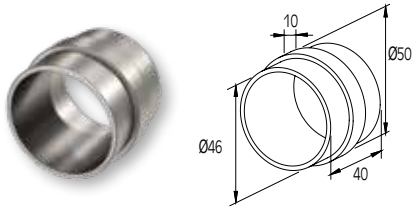

CONNECTOR FOR HANDRAIL Ø50 (INTERNAL)
JONCTION DE MAIN COURANTE F50 (INTERNE)

CODE	4241
PRICE / PRIX	2,00 €/pc

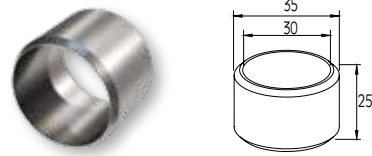

CONNECTOR FOR GUIDE Ø30 (STRAIGHT)
JONCTION DE GUIDAGE Ø30 (DROIT)

CODE	4242
PRICE / PRIX	0,95 €/pc

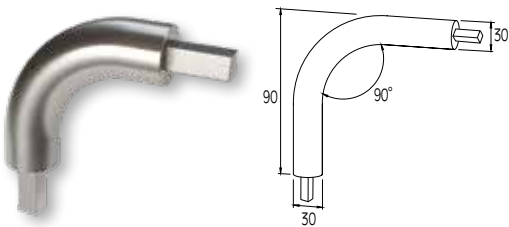

CONNECTOR 90° FOR F50-307 GUIDE
JONCTION 90° DE GUIDAGE F50-307

CODE	4243
PRICE / PRIX	5,45 €/pc

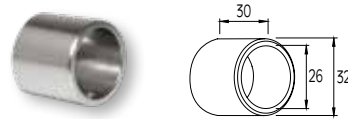

CONNECTOR FOR F50-102/106 COLUMN WITH PROFILE Ø26
JONCTION DE POTEAU F50-102/106 AVEC PROFIL Ø26

CODE	4244
PRICE / PRIX	2,65 €/pc

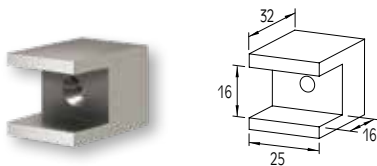

CONNECTOR FOR F50-102/106 COLUMN WITH PROFILE F50-302
JONCTION DE POTEAU F50-102/106 AVEC PROFIL F50-302

CODE	4245
PRICE / PRIX	4,00 €/pc

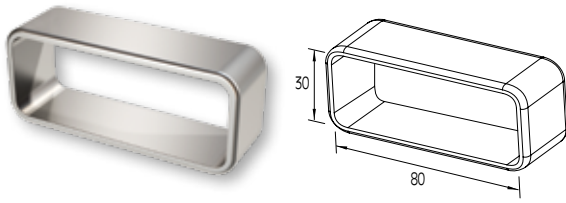

CONNECTOR FOR 80x30 HANDRAIL (STRAIGHT)
JONCTION DE MAIN COURANTE 80x30 (DROIT)

CODE	4249
PRICE / PRIX	3,05 €/pc

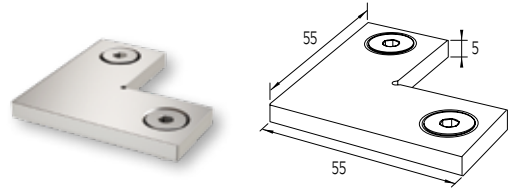

CONNECTOR 90° FOR F50-201 HANDRAIL
JONCTION 90° DE MAIN COURANTE F50-201

CODE	4250
PRICE / PRIX	4,45 €/pc

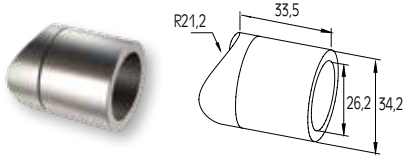

CONNECTOR FOR F50-100 COLUMN WITH PROFILE Ø26
JONCTION DE POTEAU F50-100 AVEC PROFIL Ø26

CODE	4252
PRICE / PRIX	5,05 €/pc

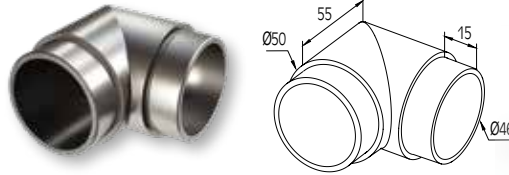

CONNECTOR 90° FOR HANDRAIL Ø50
JONCTION 90° DE MAIN COURANTE Ø50

CODE	4256
PRICE / PRIX	6,05 €/pc

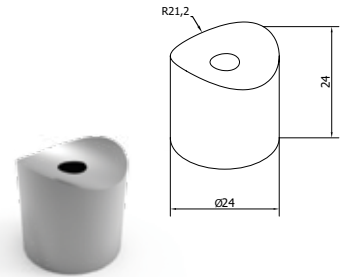

CONNECTOR FOR F50-100 COLUMN WITH F50-102 COLUMN
JONCTION DE POTEAU F50-100 AVEC POTEAU F50-102

CODE	4266
PRICE / PRIX	2,35 €/pc

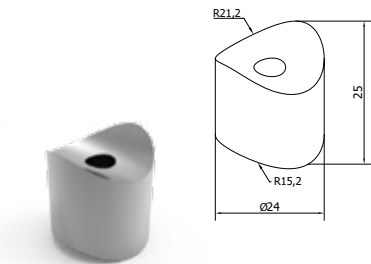

CONNECTOR FOR F50/307-327 WITH F50-103/123 COLUMN
JONCTION DE F50-307/327 AVEC POTEAU F50-103/123

CODE	4269
PRICE / PRIX	2,10 €/pc

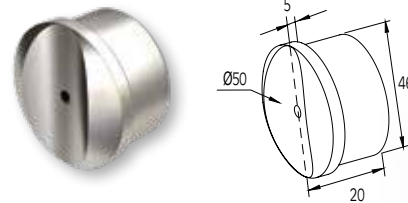

CONNECTOR FOR HANDRAIL WITH HANDRAIL F50-200
JONCTION DE MAIN COURANTE AVEC MAIN COURANTE F50-200

CODE	4257
PRICE / PRIX	5,05 €/pc

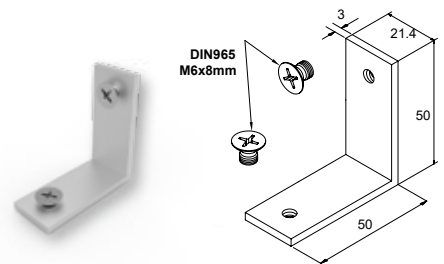

CONNECTOR FOR F50-319 GUIDE
EQUERRE DE LIAISON DU GUIDAGE F50-319

CODE	4259
PRICE / PRIX	1,90 €/pc

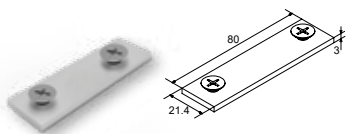

LINEAR CONNECTOR FOR F50-319 GUIDE
CONNECTEUR LINÉAIRE POUR GUIDE F50-319

CODE	4281
PRICE / PRIX	1,55 €/pc

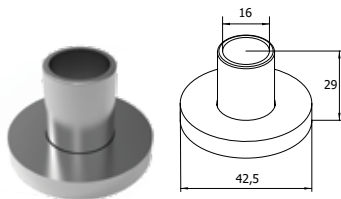

CONNECTOR WITH COVER FOR PROFILE Ø16
CONNECTEUR AVEC CAPUCHON POUR PROFIL Ø16

CODE	4284
PRICE / PRIX	4,45 €/pc

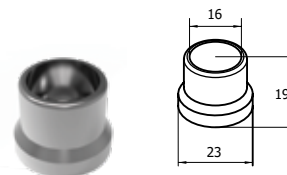

CONNECTOR FOR PROFILE Ø16
CONNECTEUR POUR PROFIL Ø16

CODE	4285
PRICE / PRIX	1,45 €/pc

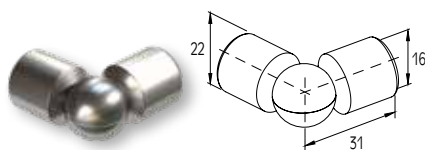

ADJUSTABLE ANGLE CONNECTOR FOR PROFILE Ø16
JONCTION ANGULAIRE DE PROFIL Ø16

CODE	4302
PRICE / PRIX	3,95 €/pc

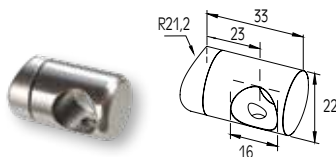

CONNECTOR FOR F50-100 COLUMN WITH PROFILE Ø16
JONCTION DE POTEAU F50-100 AVEC PROFIL Ø16

CODE	4312
PRICE / PRIX	2,10 €/pc

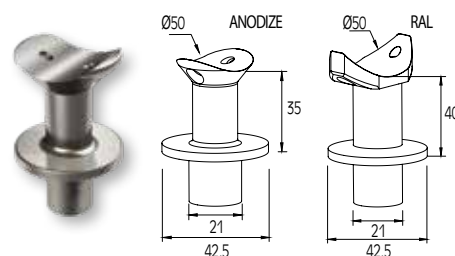

CONNECTOR FOR HANDRAIL Ø50 WITH COLUMN Ø42
JONCTION DE MAIN COURANTE Ø50 AVEC POTEAU Ø42

CODE	4314
PRICE / PRIX	3,10 €/pc

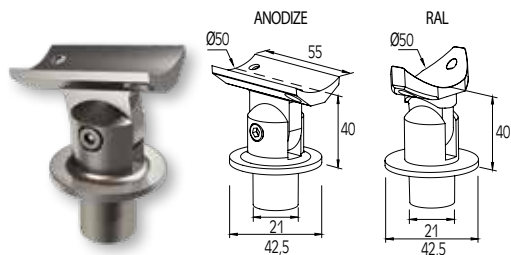

CONNECTOR FOR HANDRAIL Ø50 WITH COLUMN Ø42 (STAIRS)
JONCTION DE MAIN COURANTE Ø50 AVEC POTEAU Ø42 (ESCALIER)

CODE	4316
PRICE / PRIX	4,15 €/pc

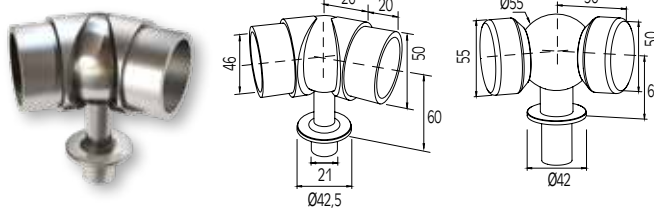

ADJUSTABLE CORNER CONNECTOR FOR HANDRAIL Ø50 WITH COLUMN Ø42
JONCTION ANGULAIRE DE MAIN COURANTE Ø50 AVEC POTEAU Ø42

CODE	4319
PRICE / PRIX	18,90 €/pc

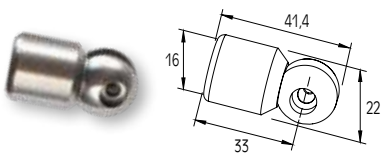

CONNECTOR FOR GLASS ROSSETTE WITH PROFILE Ø16
JONCTION DE ROSACE DE VERRE AVEC PROFIL Ø16

CODE **4322**
PRICE / PRIX **2,70 €/pc**

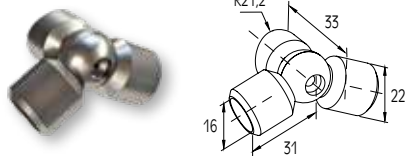

ADJUSTABLE CORNER CONNECTOR FOR PROFILE Ø16 WITH F50-100 COLUMN
JONCTION ANGULAIRE DE PROFIL Ø16 AVEC POTEAU F50-100

CODE **4323**
PRICE / PRIX **7,10 €/pc**

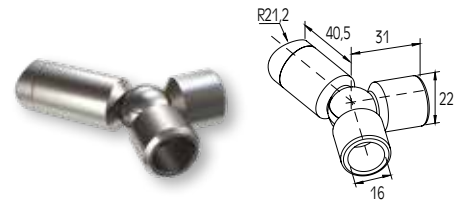

CONNECTOR 90° FOR PROFILE Ø16 WITH F50-100 COLUMN
JONCTION DE PROFIL Ø16 AVEC POTEAU F50-100

CODE **4324**
PRICE / PRIX **4,75 €/pc**

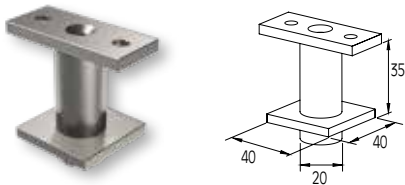

SUPPORT FOR F50-102 COLUMN WITH F50-201 HANDRAIL
FIXATION DE POTEAU F50-102 AVEC MAIN COURANTE F50-201

CODE **4328**
PRICE / PRIX **4,75 €/pc**

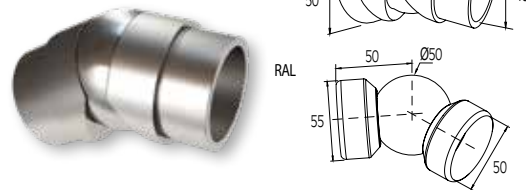

ADJUSTABLE CORNER CONNECTOR FOR COLUMN Ø50
JONCTION ANGULAIRE DE MAIN COURANTE Ø50

CODE **4329**
PRICE / PRIX **9,20 €/pc**

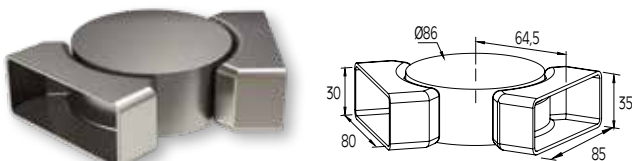

ADJUSTABLE CORNER CONNECTOR FOR F50-201/203 HANDRAIL
JONCTION ANGULAIRE DE MAIN COURANTE F50-201/203

CODE **4332**
PRICE / PRIX **15,40 €/pc**

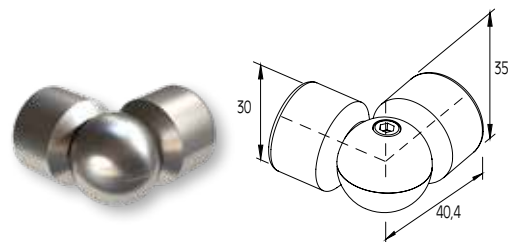

ADJUSTABLE CORNER CONNECTOR FOR F50-307 GUIDE
JONCTION ANGULAIRE DE GUIDAGE F50-307

CODE **4333**
PRICE / PRIX **7,00 €/pc**

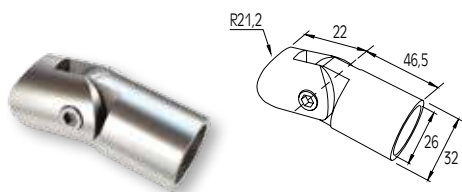

CONNECTOR FOR F50-100 COLUMN WITH PROFILE Ø26
 JONCTION DE POTEAU F50-100 AVEC PROFIL Ø26

CODE	4335
PRICE / PRIX	8,50 €/pc

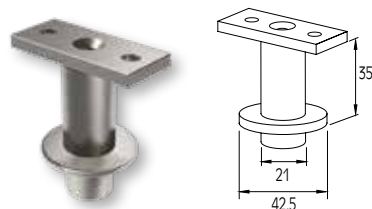

CONNECTOR FOR F50-100 COLUMN WITH F50-201 HANDRAIL
 JONCTION DE POTEAU F50-100 AVEC MAIN COURANTE F50-201

CODE	4337
PRICE / PRIX	5,40 €/pc

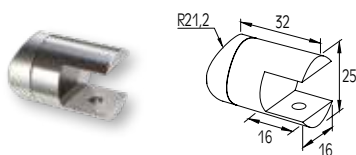

CONNECTOR FOR F50-100 COLUMN WITH F50-302 PROFILE
 JONCTION DE POTEAU F50-100 AVEC PROFIL F50-302

CODE	4341
PRICE / PRIX	4,15 €/pc

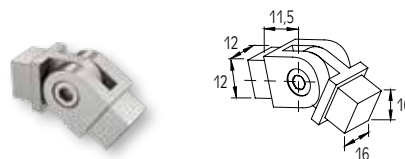

ADJUSTABLE CORNER CONNECTOR FOR F50-302 PROFILE
 JONCTION ANGULAIRE DE PROFIL F50-302

CODE	4342
PRICE / PRIX	9,55 €/pc

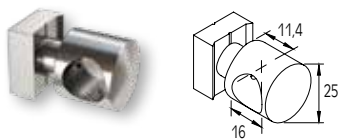

CONNECTOR FOR PROFILE Ø16 WITH BLADE COLUMN
 JONCTION DE PROFIL Ø16 AVEC POTEAU BLADE

CODE	4343
PRICE / PRIX	3,65 €/pc

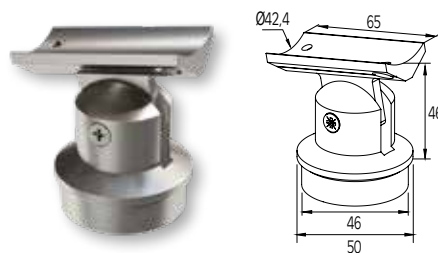

CONNECTOR FOR F50-100 COLUMN WITH F50-200 HANDRAIL
 JONCTION DE MAIN COURANTE F50-100 AVEC POTEAU F50-200

CODE	4344
PRICE / PRIX	6,35 €/pc

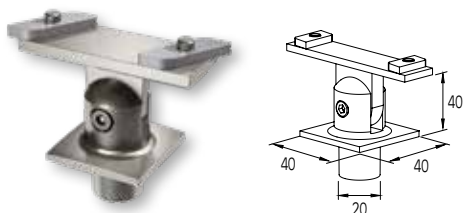

CONNECTOR FOR F50-102 COLUMN WITH F50-201 HANDRAIL
JONCTION DE MAIN COURANTE F50-102 AVEC POTEAU F50-201

CODE	4345
PRICE / PRIX	5,90 €/pc

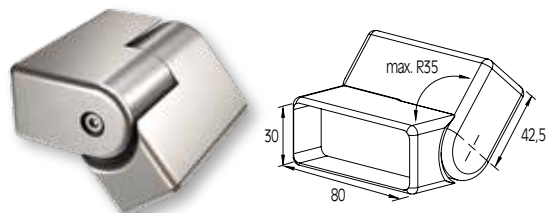

ADJUSTABLE CORNER CONNECTOR FOR 80x30 HANDRAIL (STAIRS)
JONCTION ANGULAIRE DE POTEAU 80x30 (ESCALIER)

CODE	4346
PRICE / PRIX	23,20 €/pc

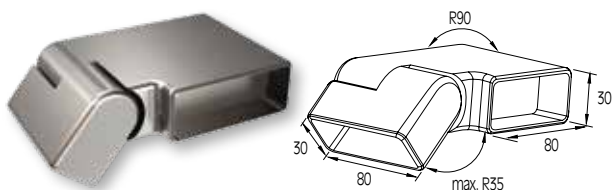

ADJUSTABLE CORNER CONNECTOR 90° FOR 80x30 HANDRAIL (STAIRS)
JONCTION ANGULAIRE 90° DE POTEAU 80x30 (ESCALIER)

CODE	4347
PRICE / PRIX	41,30 €/pc

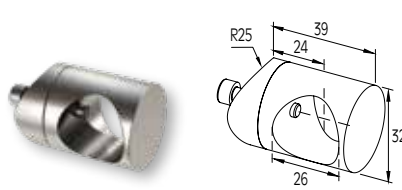

CONNECTOR FOR F50-101 COLUMN WITH PROFILE Ø26
JONCTION DE MAIN COURANTE F50-101 AVEC PROFIL Ø26

CODE	4348
PRICE / PRIX	5,90 €/pc

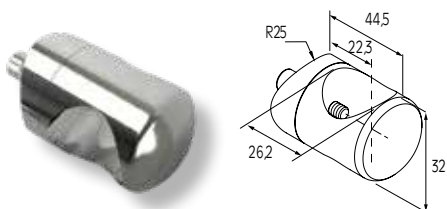

CONNECTOR OVAL FOR F50-101 COLUMN WITH PROFILE Ø26
JONCTION OVALE DE MAIN COURANTE F50-101 AVEC PROFIL Ø26

CODE	4348B
PRICE / PRIX	6,20 €/pc

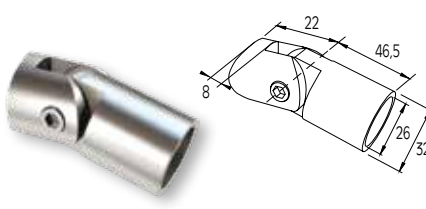

CONNECTOR FOR F50-102 COLUMN WITH PROFILE Ø26
JONCTION DE MAIN COURANTE F50-102 AVEC PROFIL Ø26

CODE	4349
PRICE / PRIX	8,05 €/pc

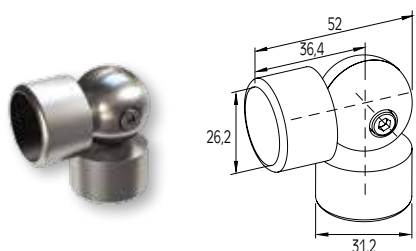

ADJUSTABLE CORNER CONNECTOR FOR PROFILE Ø26
JONCTION ANGULAIRE DE PROFIL Ø26

CODE	4352
PRICE / PRIX	7,00 €/pc

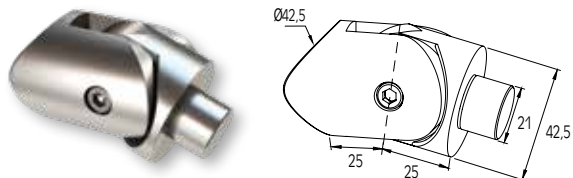

CONNECTOR FOR COLUMN WITH COLUMN F50-100 (STAIRS)
JONCTION DE POTEAU AVEC POTEAU F50-100 (ESCALIER)

CODE	4355
PRICE / PRIX	14,90 €/pc

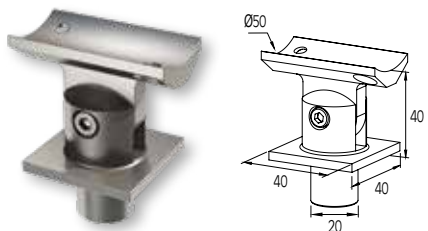

SUPPORT FOR F50-200 HANDRAIL WITH F50-102 COLUMN (STAIRS)
FIXATION DE MAIN COURANTE F50-200 AVEC POTEAU F50-102 (ESCALIER)

CODE	4356
PRICE / PRIX	4,45 €/pc

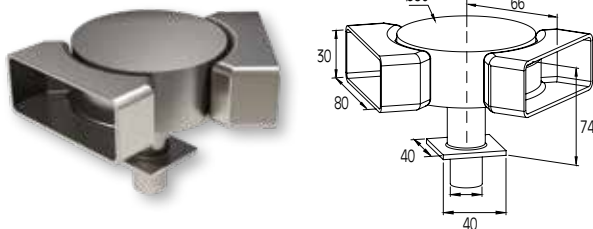

ADJUSTABLE CORNER CONNECTOR FOR 80x30 HANDRAIL WITH F50-102 COLUMN
JONCTION ANGULAIRE DE MAIN COURANTE 80x30 AVEC POTEAU F50-102

CODE	4357
PRICE / PRIX	20,50 €/pc

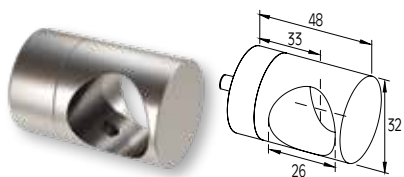

CONNECTOR FOR F50-102 COLUMN WITH PROFILE Ø26
JONCTION DE POTEAU F50-102 AVEC PROFIL Ø26

CODE	4358
PRICE / PRIX	6,00 €/pc

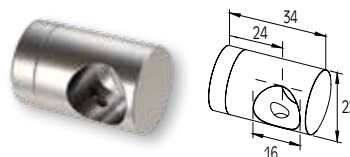

CONNECTOR FOR F50-102 COLUMN WITH PROFILE Ø16
JONCTION DE POTEAU F50-102 AVEC PROFIL Ø16

CODE	4359
PRICE / PRIX	2,60 €/pc

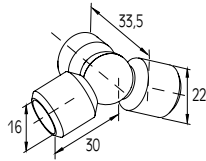

ADJUSTABLE CORNER CONNECTOR FOR PROFILE Ø16 WITH F50-102 COLUMN
JONCTION DE PROFIL Ø16 AVEC POTEAU F50-102

CODE	4360
PRICE / PRIX	8,60 €/pc

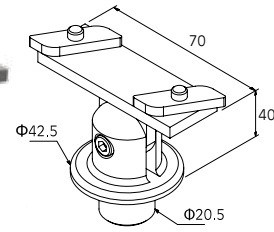

SUPPORT FOR F50-201 HANDRAIL WITH F50-100 COLUMN (STAIRS)
FIXATION DE MAIN COURANTE F50-201 AVEC POTEAU F50-100(ESCALIER)

CODE	4361
PRICE / PRIX	6,35 €/pc

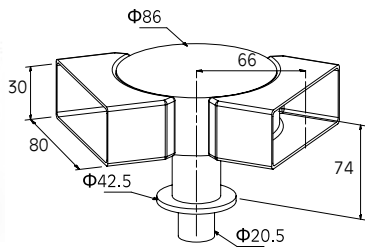

ADJUSTABLE CORNER CONNECTOR FOR HANDRAIL 80x30 WITH COLUMN F50-100
JONCTION ANGULAIRE DE MAIN COURANTE 80x30 AVEC POTEAU F50-100

CODE	4373
PRICE / PRIX	21,00 €/pc

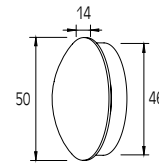

END CAP FOR F50-200 HANDRAIL
EMBOUT DE MAIN COURANTE F50-200

CODE	4434
PRICE / PRIX	1,45 €/pc

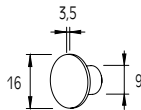

END CAP FOR F50-301 PROFILE
EMBOUT DE PROFIL F50-301

CODE	4435
PRICE / PRIX	0,45 €/pc

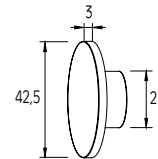

END CAP FOR F50-100 COLUMN
EMBOUT DE POTEAU F50-100

CODE	4436
PRICE / PRIX	1,60 €/pc

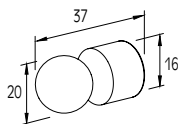

END COVER FOR PROFILE Ø16
EMBOUT DE PROFIL Ø16

CODE	4437
PRICE / PRIX	1,45 €/pc

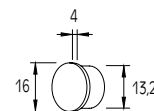

END CAP FOR F50-300 PROFILE
EMBOUT DE PROFIL F50-300

CODE	4438
PRICE / PRIX	0,55 €/pc

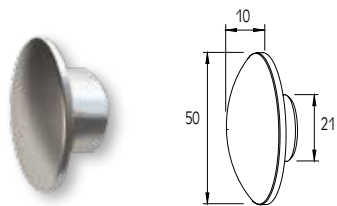

END CAP FOR F50-101 COLUMN
EMBOUT DE POTEAU F50-101

CODE	4443
PRICE / PRIX	2,90 €/pc

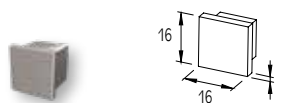

END CAP FOR F50-302 PROFILE
EMBOUT DE PROFIL F50-302

CODE	4444
PRICE / PRIX	0,95 €/pc

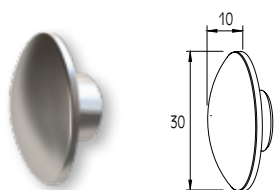

END CAP FOR F50-307 GUIDE
EMBOUT DE GUIDAGE F50-307

CODE	4446
PRICE / PRIX	1,45 €/pc

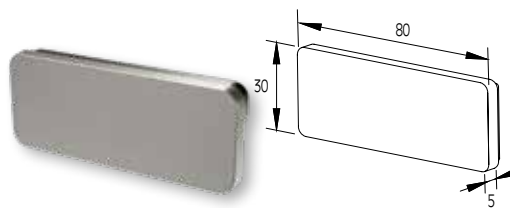

END CAP FOR F50-201 HANDRAIL
EMBOUT DE MAIN COURANTE F50-201

CODE	4447
PRICE / PRIX	2,70 €/pc

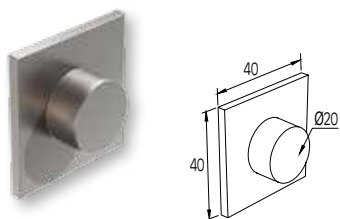

END CAP FOR F50-102 COLUMN
EMBOUT DE POTEAU F50-102

CODE	4448
PRICE / PRIX	1,75 €/pc

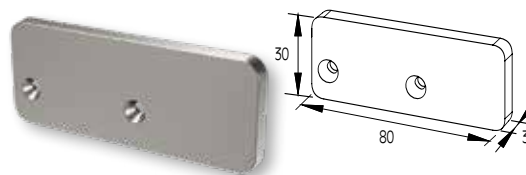

END CAP FOR F50-203 HANDRAIL
EMBOUT DE MAIN COURANTE F50-203

CODE	4451
PRICE / PRIX	4,75 €/pc

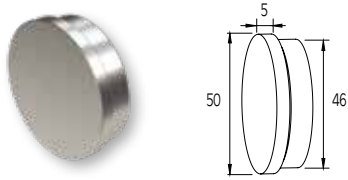

END CAP FOR F50-200 HANDRAIL (FLAT)
EMBOUT DE MAIN COURANTE F50-200 (PLAT)

CODE	4453
PRICE / PRIX	2,25 €/pc

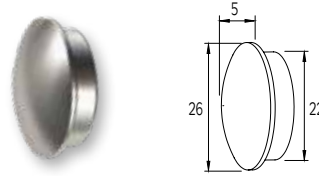

END CAP FOR F50-304 PROFILE
EMBOUT DE PROFIL F50-304

CODE	4461
PRICE / PRIX	1,30 €/pc

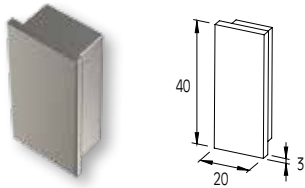

END CAP FOR PROFILE 59-009 (40x20)
EMBOUT DE PROFIL 59-009 (40x20)

CODE	4464
PRICE / PRIX	2,90 €/pc

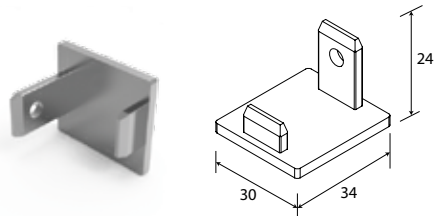

END CAP FOR F50-319 GUIDE
EMBOUT DE GUIDAGE F50-319

CODE	4477
PRICE / PRIX	2,70 €/pc

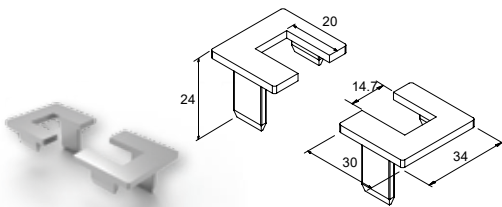

END CAP FOR F50-319 GUIDE (PERFORATED)
EMBOUT OUVERTE DE GUIDAGE F50-319

CODE	4478
PRICE / PRIX	7,40 €/pair

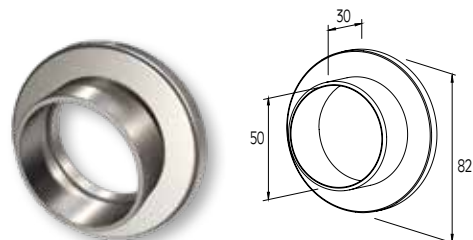

WALL COVER FOR HANDRAIL Ø50 WITH CAP
CACHE DU MUR DE MAIN COURANTE Ø50(+CAPUCHON)

CODE	4509Z
PRICE / PRIX	5,20 €/pc

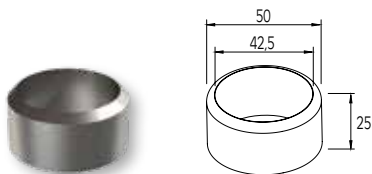

WALL COVER FOR COLUMN Ø42
CACHE DU MUR DE POTEAU Ø42

CODE	4510
PRICE / PRIX	1,25 €/pc

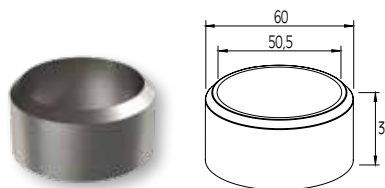

WALL COVER FOR F50-101 COLUMN
CACHE DU MUR DE POTEAU F50-101

CODE	4513
PRICE / PRIX	1,90 €/pc

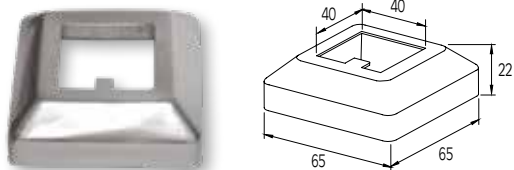

WALL COVER FOR F50-102 COLUMN
CACHE DU MUR DE POTEAU F50-102

CODE	4514
PRICE / PRIX	1,85 €/pc

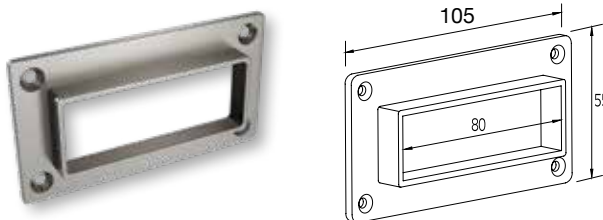

WALL COVER FOR F50-201/203 HANDRAIL
CACHE DU MUR DE MAIN COURANTE F50-201/203

CODE	4515
PRICE / PRIX	5,25 €/pc

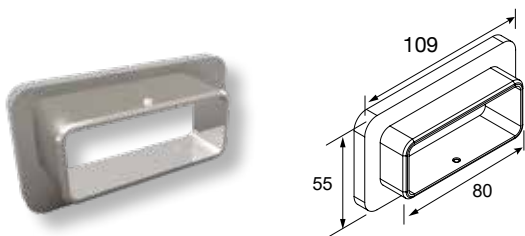

WALL COVER FOR F50-201/203 HANDRAIL (WITH CAP)
CACHE DU MUR DE MAIN COURANTE F50-201/203 (+CAPUCHON)

CODE	4515Z
PRICE / PRIX	7,95 €/pc

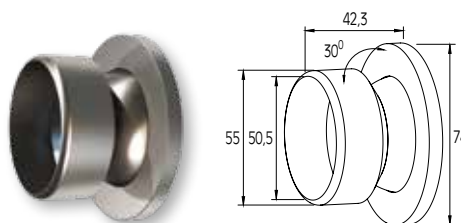

WALL COVER FOR HANDRAIL Ø50 WITH CAP
CACHE DU MUR DE MAIN COURANTE Ø50 (+CAPUCHON)

CODE	4518
PRICE / PRIX	9,10 €/pc

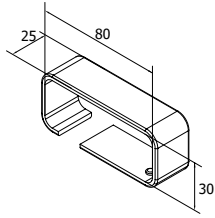

CONNECT.FOR 80X30 HANDR. (STRAIGHT)
RACCORD DE MAIN COURRANTE 80X30 (DROIT)

CODE	4287
PRICE / PRIX	4,50 €/pc

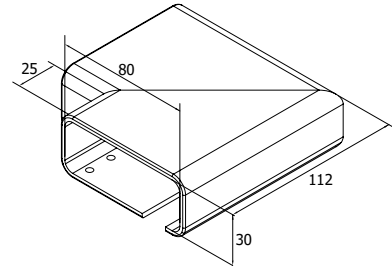

CONNECTOR 90° 80X30 HANDRAIL
RACCORD 90° DE MAIN COURRANTE 80X30

CODE	4288
PRICE / PRIX	14,85 €/pc

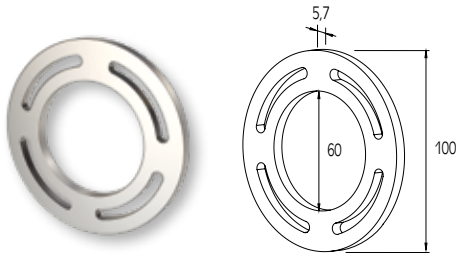

GLASS ROSETTE Ø100
ROSETTE DE VERRE Ø100

CODE	4611
PRICE / PRIX	4,75 €/pc

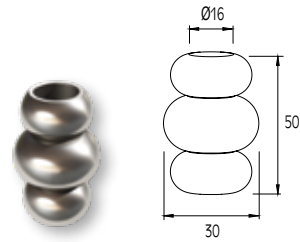

GLASS ROSETTE FOR PROFILE Ø16
ROSETTE DE PROFIL Ø16

CODE	4618
PRICE / PRIX	2,90 €/pc

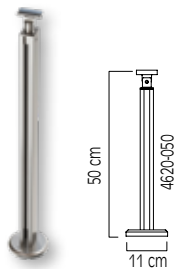

READY MADE COLUMN FOR Ø16 PROFILE HEIGHT 50 cm
POTEAU PRET 50 CM POUR PROFIL Ø16

CODE	4620-050
PRICE / PRIX	36,60 €/pc

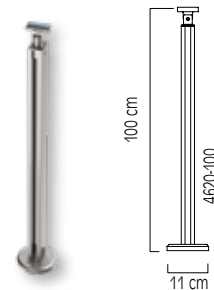

READY MADE COLUMN FOR Ø16 PROFILE HEIGHT 100 cm
POTEAU PRET 100 CM POUR PROFIL Ø16

CODE	4620-100
PRICE / PRIX	48,50 €/pc

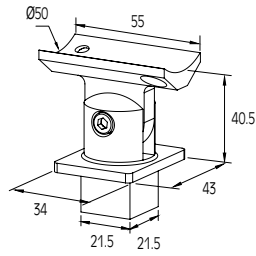

SUPPORT FOR HANDRAIL Ø50 WITH BLADE COLUMN
FIXATION DE MAIN COURANTE Ø50 AVEC POTEAU BLADE

CODE	4620-310
PRICE / PRIX	7,35 €/pc

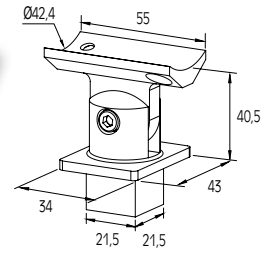

SUPPORT FOR HANDRAIL Ø42 WITH BLADE COLUMN
FIXATION DE MAIN COURANTE Ø42 AVEC POTEAU BLADE

CODE	4620-311
PRICE / PRIX	7,85 €/pc

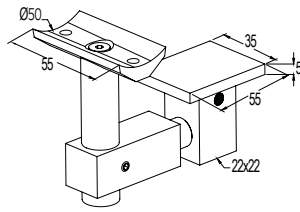

SUPPORT FOR HANDRAIL Ø50 WITH BLADE COLUMN
FIXATION DE MAIN COURANTE Ø50 AVEC POTEAU BLADE

CODE	4620-312
PRICE / PRIX	12,50 €/pc

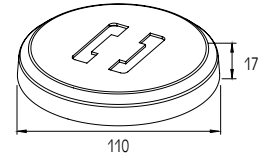

SUPPORT FOOT FOR F50-108 COLUMN
SABOT DE POTEAU F50-108

CODE	4620-320
PRICE / PRIX	10,60 €/pc

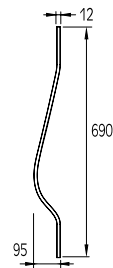

CURVED PROFILE FOR VERTICAL-D (70cm)
PROFIL COURBE POUR VERTICAL D (70cm)

CODE	4670
PRICE / PRIX	3,50 €/pc

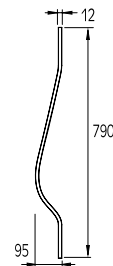

CURVED PROFILE FOR VERTICAL-D (80cm)
PROFIL COURBE POUR VERTICAL D (80cm)

CODE	4680
PRICE / PRIX	3,85 €/pc

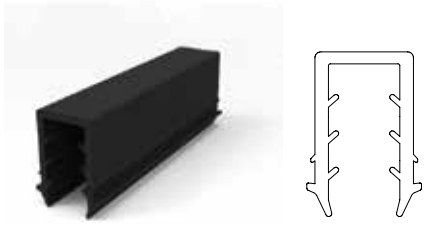

"U" SHAPE GASKET FOR 10.76mm GLASS
JOINT DU GUIDAGE POUR VERRE 10.76mm

CODE	4910
PRICE / PRIX	2,70 €/m

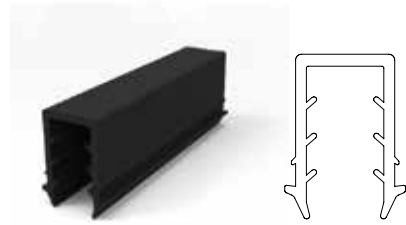

"U" SHAPE GASKET FOR 11.52mm GLASS
JOINT DU GUIDAGE POUR VERRE 11.52mm

CODE	4911
PRICE / PRIX	2,40 €/m

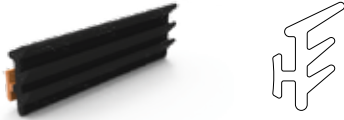

GASKET FOR F50-319 RAIL (10mm GLASS)
JOINT DU GUIDAGE F50-319 (10mm VERRE)

CODE	4912
PRICE / PRIX	0,45 €/m



GLAZING GASKET 3mm BLACK
VITRAGE JOINT 3mm NOIR

CODE	US530-3PRM
PRICE / PRIX	4,70 €/Kg

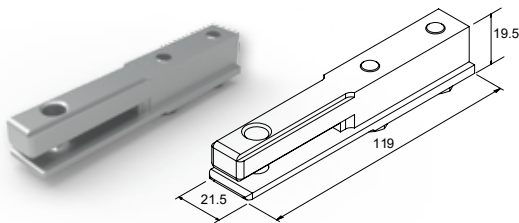

HOLES CALIBRE FOR F50-319
CALIBREUR POUR TROUS DE F50-319

CODE	4971
PRICE / PRIX	131,50 €/pc

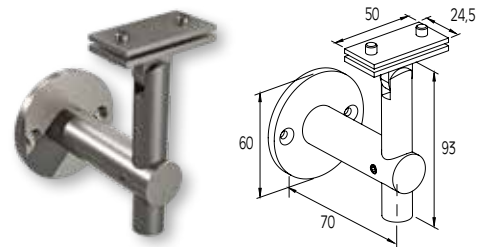

F50-201 RAILTOP WALL SUPPORT
F50-201 RAILTOP WALL SUPPORT

CODE	F85-452
PRICE / PRIX	14,70 €/pc

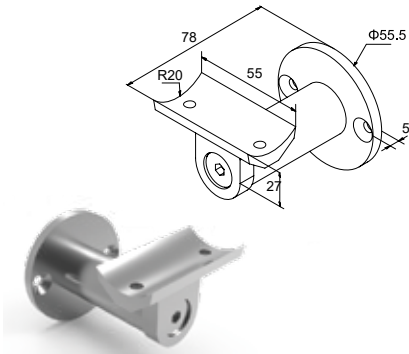

CODE **4135**
 WALL SUPPORT FOR Ø40 HANDRAIL
 FIXATION MURALE DE MAIN COURANTE Ø40
 PRICE / PRIX **6,05 €/pc**

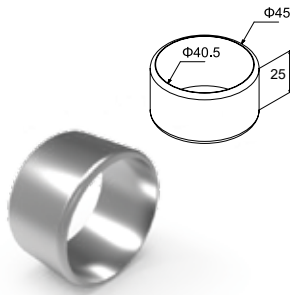

CODE **4260**
 CONNECTOR FOR HANDRAIL Ø40
 JONCTION DE MAIN COURANTE Ø40
 PRICE / PRIX **3,20 €/pc**

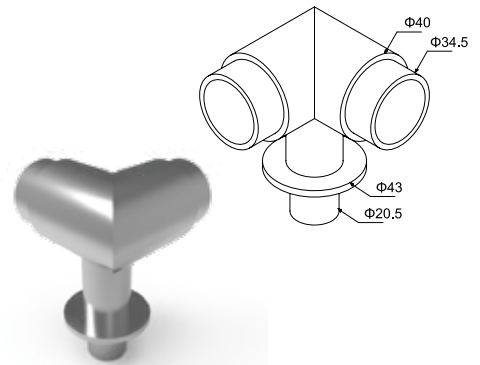

CODE **4262**
 CONNECTOR 90° FOR HANDRAIL Ø40
 JONCTION 90° DE MAIN COURANTE Ø40
 PRICE / PRIX **11,90 €/pc**

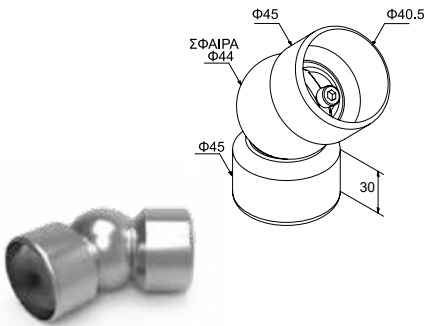

CODE **4367**
 ADJUSTABLE CORNER CONNECTOR FOR HANDRAIL Ø40
 JONCTION ANGULAIRE DE MAIN COURANTE Ø40
 PRICE / PRIX **8,30 €/pc**

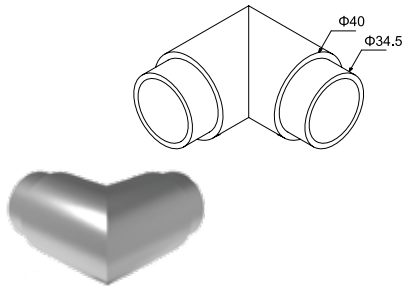

CODE **4277**
 CONNECTOR 90° FOR HANDRAIL Ø40
 JONCTION 90° DE MAIN COURANTE Ø40
 PRICE / PRIX **6,95 €/pc**

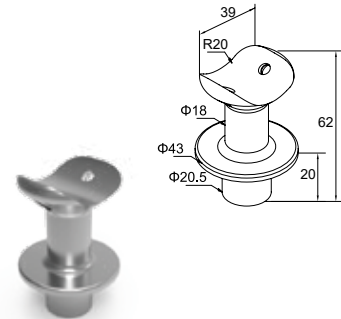

CODE **4368**
 SUPPORT FOR HANDRAIL Ø40 WITH COLUMN Ø42
 FIXATION DE MAIN COURANTE Ø40 AVEC POTEAU Ø42
 PRICE / PRIX **3,65 €/pc**

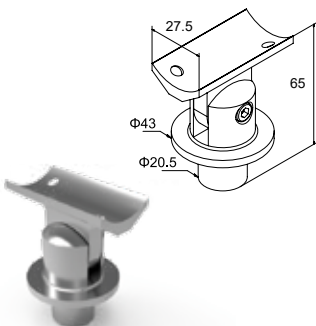

CODE **4369**
 ADJUSTABLE CORNER SUPPORT FOR HANDRAIL
 Ø40 WITH COLUMN Ø42
 FIXATION ANGULAIRE DE MAIN COURANTE Ø40
 AVEC POTEAU Ø42
 PRICE / PRIX **6,40 €/pc**

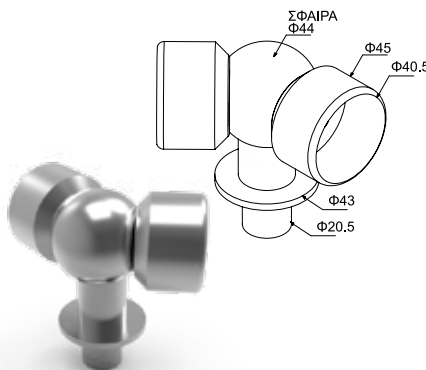

CODE **4370**
 ADJUSTABLE CORNER CONNECTOR FOR HANDRAIL Ø40
 WITH COLUMN Ø42
 JONCTION DE MAIN COURANTE Ø40 AVEC POTEAU Ø42
 PRICE / PRIX **19,20 €/pc**

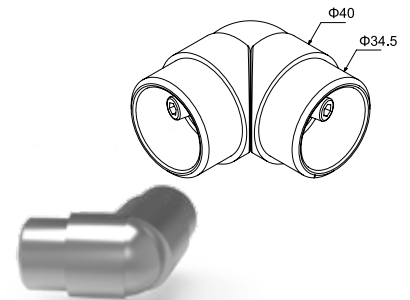

CODE **4371**
 ADJUSTABLE CORNER CONNECTOR FOR HANDRAIL Ø40
 JONCTION ANGULAIRE DE MAIN COURANTE Ø40
 PRICE / PRIX **9,55 €/pc**

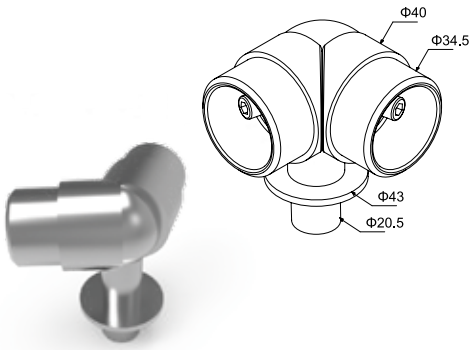

CODE **4372**
 ADJUSTABLE CORNER CONNECTOR FOR HANDRAIL Ø40 WITH COLUMN Ø42
 JONCTION ANGULAIRE DE MAIN COURANTE Ø40 AVEC POTEAU Ø42
 PRICE / PRIX **15,10 €/pc**

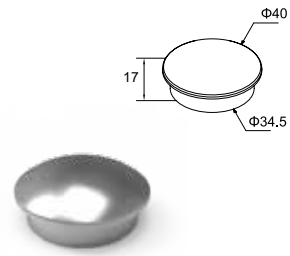

CODE **4479**
 END CAP FOR HANDRAIL Ø40
 EMBOUT DE MAIN COURANTE Ø40
 PRICE / PRIX **1,30 €/pc**

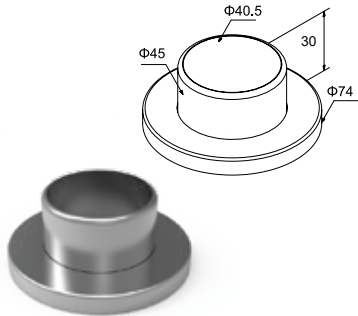

WALL COVER FOR HANDRAIL Ø40
 CACHE DU MUR DE MAIN COURANTE Ø40
 CODE **4520Z**
 PRICE / PRIX **5,45 €/pc**

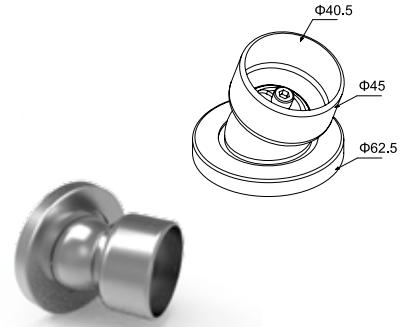

CODE **4521**
 WALL COVER FOR HANDRAIL Ø40 WITH CAP
 CACHE DU MUR DE MAIN COURANTE Ø40 (+CAPUCHON)
 PRICE / PRIX **10,10 €/pc**

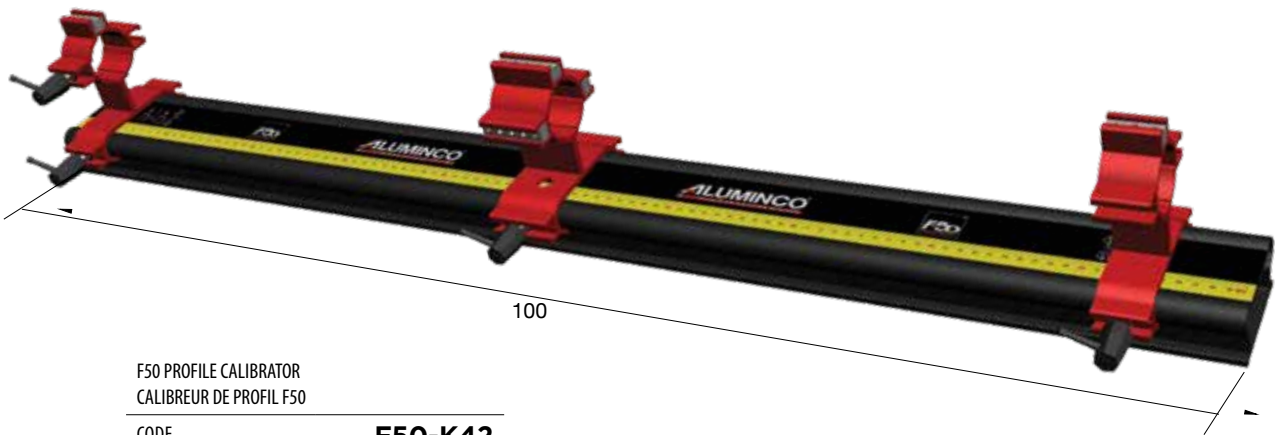

F50 PROFILE CALIBRATOR
CALIBREUR DE PROFIL F50

CODE	F50-K42
PRICE / PRIX	180,00 €/pc



- In proportion 1:1
- Working time 7-8 min
- Initial welding time 15-18 min
- Complete welding time 3-6 hours

- En proportion 1:1
- Temps d'ouvrage 7-8 min.
- Temps initial de soudage 15-18 min
- Temps complet de soudage 3-6 h.

GLUE 9450 50ml
COLLE 9450 50ml

CODE	6K945
PRICE / PRIX	28,70 €/pc



- Working time 15-20 minutes
- Temps de durcissement 15-20 min

RESIN FOR INFLOOR SUPPORTING ACCESSORIES 4167 & 4188
RESINE POUR ACCESSOIRES DE SUPPORT ENCASTRES

CODE	UA320.01ELA
PRICE / PRIX	7,03 €/pc



GLUE MIXER ACCESSORY
MELANGEUR DE COLLE 9450 DE F50

CODE	6KA100
PRICE / PRIX	2,15 €/pc



RESIN MIXER ACCESSORY
MELANGEUR DE RESINE UVT410

CODE	6KA102
PRICE / PRIX	1,30 €/pc



GLUE APPLICATION PISTOL
PISTOLET POUR COLLE

CODE	6KA020
PRICE / PRIX	48,40 €/pc

TORX CONCRETE SCREW

Code	Dimensions dxL	Additional features Caractéristiques supplémentaires	Selfdrilled Auto-perce	Package	Price / Prix
EBM-75G92	7.5x92	GALVANIZED / CONCRETE / BRICK / TORX	NO	150/box	0,10 €/pc
EBM-75G112	7.5x112	GALVANIZED / CONCRETE / BRICK / TORX	NO	150/box	0,12 €/pc

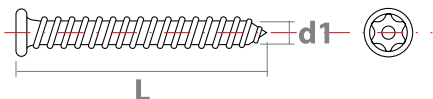

Tool: DRILL No 6 / TORX T30
Outil: PERCEUSE No 6 / TORX T30

MANDATORY USE OF RESIN
USAGE DE RESINE OBLIGATOIRE

Accessories / Accessoires

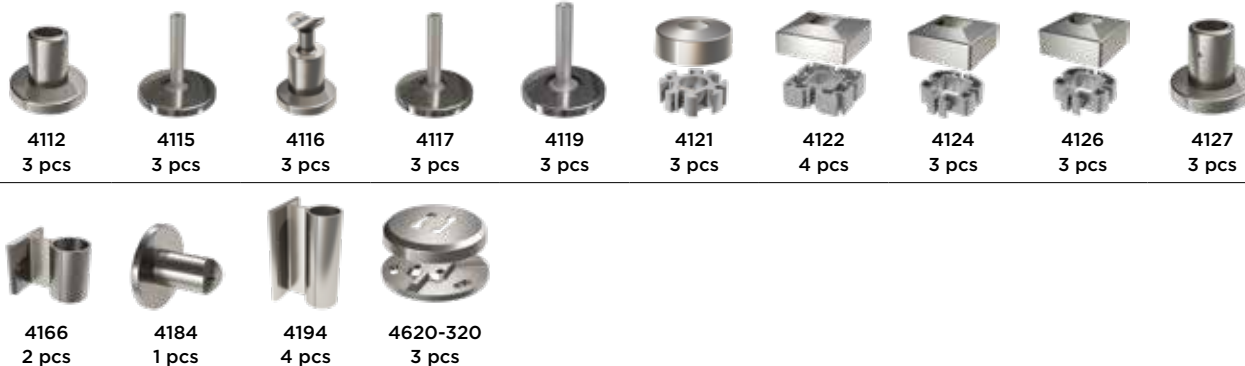

SELF-DRILLED SCREW / VIS AUTO-PERCE

Code	Dimensions dxL	Additional features Caractéristiques supplémentaires	Selfdrilled Auto-perce	Package	Price / Prix
D7504-P002I	4.2x19 DIN 7504P	INOX / For aluminium INOX / Pour aluminium	YES	1000/box	0,05 €/pc

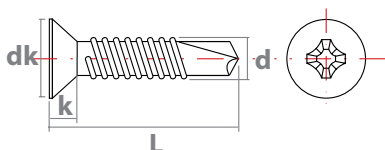

Tool: PHILLIPS BIT PH2
Outil: PHILLIPS BIT PH2

Accessories / Accessoires



SELF-DRILLED SCREW / VIS AUTO-PERCE

Code	Dimensions dxL	Additional features Caractéristiques supplémentaires	Selfdrilled Auto-percee	Package	Price / Prix
D7504-P005I	4.8x38 DIN 7504P	INOX / For aluminium INOX / Pour aluminium	YES OUI	200 / box / Boite	0,13 €/pc

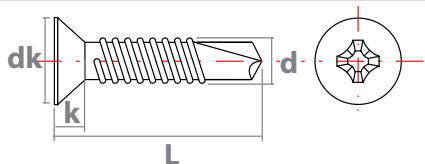

Tool: PHILLIPS BIT PH2
Outil: PHILLIPS BIT PH2

Accessories / Accessoires



SELF-DRILLED SCREW / VIS AUTO-PERCE

Code	Dimensions dxL	Additional features Caractéristiques supplémentaires	Selfdrilled Auto-percee	Package	Price / Prix
D7504-P003I	4.2x38 DIN 7504P	INOX / For aluminium INOX / Pour aluminium	YES OUI	200 / box / Boite	0,07 €/pc

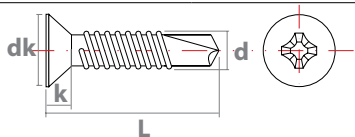

Tool: PHILLIPS BIT PH2
Outil: PHILLIPS BIT PH2

Accessories / Accessoires



TAPPING SCREW-PLASTIC PLUG / VIS DE TAPOTEMENT - PRISE EN PLASTIQUE

Code	Dimensions dxL	Additional features Caractéristiques supplémentaires	Selfdaarilled Auto-perceee	Package	Price / Prix
D7982-001I	4.8x38 DIN 7982	INOX / For plastic PLUG No6 INOX / Pour plastique plug No6	YES OUI	200 / box / Boite	0,07 €/pc

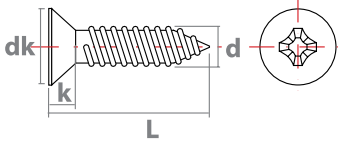

Outil: PHILLIPS BIT PH2

Code	Dimensions dxL	Additional features Caractéristiques supplémentaires	Selfdaarilled Auto-perceee	Package	Price / Prix
EB01P-0630X	No 6x30	PLASTIC / 4.8x38 PLASTIQUE / 4.8X38	-	500 / box / Boite	0,03 €/pc



Tool: DRILL No 6
Outil: DRILL No 6

Accessories / Accessoires



ALLEN SCREW - METALLIC ANCHOR / VIS A SIX PANS CREUX - ANCRE METALLIQUE

Code	Dimensions dxL	Additional features Caractéristiques supplémentaires	Selfdaarilled Auto-perceee	Package	Price / Prix
EB912-0100I	M10x100 DIN 912	INOX / CONCRETE / For metallic anchor M10 INOX / MARBRE / Pour ancre métallique M10	NO	100 / box	0,97 €/pc
EB912-0120I	M10x120 DIN 912	INOX / MARBLE / For metallic anchor M10 INOX / MARBRE / Pour ancre métallique M10	NO	100 / box	1,61 €/pc
EB912-1070I	M10x70 DIN 912	INOX / MARBLE / For metallic anchor M10 INOX / MARBRE / Pour ancre métallique M10	OXI	50 / box	0,63 €/pc

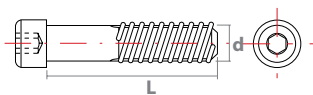

Tool: DRILL No 8
Outil: DRILL No 8

Code	Dimensions dxL	Additional features Caractéristiques supplémentaires	Selfdaarilled Auto-perceee	Package	Price / Prix
EB01M-1040G	M10x40	GALVANIZED / For M10x100 & M10x120 GALVANIZE / Pour M10x100 & M10x120	-	50 / box	0,60 €/pc

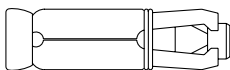

Tool: DRILL No 10
Outil: DRILL No 10

Accessories / Accessoires



4139
2 pcs



4142
2 pcs



4143
2 pcs



4144
2 pcs

Type	Shape Forme	Basic profile Profil de base	Sample
ACCORD		F50-100	F50-1001 50x50: 30 €/pc 100x100: 45 €/pc
		F50-200	
		F50-300	
ACCORD QUATTRO		F50-100	F50-1003 50x50: 30 €/pc 100x100: 45 €/pc
		F50-200	
		F50-302	
ACCORD SQUARE		F50-201	F50-1004 50x50: 30 €/pc 100x100: 45 €/pc
		F50-102	
		F50-122	
ACCORD X SQUARE		F50-302	F50-1007 50x50: 30 €/pc 100x100: 45 €/pc
		F50-201	
		F50-102	
ACCORD SQUARE Q		F50-122	F50-1005 50x50: 30 €/pc 100x100: 45 €/pc
		F50-201	
		F50-300	
ACCORD TUBULAR		F50-201	F50-1006 50x50: 30 €/pc 100x100: 45 €/pc
		F50-102	
		F50-304	
ACCORD BLADE		F50-200	F50-1002 50x50: 30 €/pc 100x100: 45 €/pc
		F50-300	
		F50-108	

Type	Shape Forme	Basic profile Profil de base	Sample
HORIZON		 F50-100 F50-200	F50-1008 50x50: 30 €/pc 100x100: 45 €/pc
HORIZON X-RAIL		 F50-100 F50-200 F50-300	F50-1015 50x50: 30 €/pc 100x100: 45 €/pc
HORIZON SQUARE X-RAIL		 F50-201 F50-102 F50-122 F50-300	F50-1016 50x50: 30 €/pc 100x100: 45 €/pc
HORIZON U-RAIL		 F50-100 F50-200 F50-305	F50-1014 50x50: 30 €/pc 100x100: 45 €/pc
HORIZON FRAME		 F50-203 F50-223 F50-106 F50-319 F50-3K19	F50-1010 50x50: 30 €/pc 100x100: 45 €/pc
HORIZON H-RINGS		 F50-200 F50-101 F50-121	F50-1011 50x50: 30 €/pc 100x100: 45 €/pc
HORIZON BLADE		 F50-200 F50-108	F50-1009 50x50: 30 €/pc 100x100: 45 €/pc
HORIZON QUATTRO		 F50-201 F50-102 F50-122	F50-1013 50x50: 30 €/pc 100x100: 45 €/pc

Type	Shape Forme	Basic profile Profil de base	Sample
HORIZON MAX		 F50-200 F50-103 F50-123	F50-1012 50x50: 30 €/pc 100x100: 45 €/pc
VERTICAL		 F50-100 F50-200	F50-1017 50x50: 30 €/pc 100x100: 45 €/pc
VERTICAL-R		 F50-200 F50-200 F50-306K F50-306P	F50-1020 50x50: 30 €/pc 100x100: 45 €/pc
VERTICAL-D		 F50-201 F50-102 F50-122 F50-307 F50-327 F50-308	F50-1018 50x50: 30 €/pc 100x100: 45 €/pc
VERTICAL-Q		 F50-203 F50-223 F50-106 F50-319 F50-3K19 F50-311	F50-1019 50x50: 30 €/pc 100x100: 45 €/pc
SLIM LINE		 F50-100 F50-300 F50-209	F50-1021 50x50: 30 €/pc 100x100: 45 €/pc
CLASSIC EUROPEAN	 100 cm 100 cm	 F50-319 F50-3K19	F50-1022 50x50: 30€/τεμ. pc 100x100: 45€/τεμ. pc



320 11 Inofita Viotia, Greece
T. +30 22620 47000 F. +30 22620 47090
www.aluminco.com