

ALUMINCO[®]

ALUMINIUM BUILDING SYSTEMS

Railings, Gates & Fences for every project

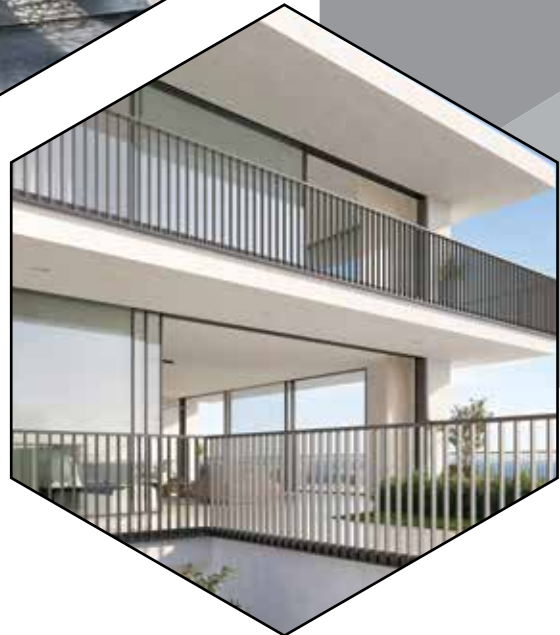

ΠΕΡΙΕΧΟΜΕΝΑ / CONTENTS

CLS RAILINGS	4
PSATHA	10
ALFLEX	48
ΤΟΠΟΘΕΤΗΣΗ/INSTALLATION	56
Synthesis	60
Linear	62
GATES & FENCES	68
ΤΟΠΟΘΕΤΗΣΗ / INSTALLATION	70
THE LINEAR GATE	72
THE XPAND SOLUTION	74
MODULAR FENCE	78
THE WD SERIES	82
DESIGNER FENCES	90
DESIGNER RAILING	92
THE BLIND GATES & FENCES	94
THE FIN SERIES	112
LINE GATE & FENCE	116
ΠΡΟΦΙΛ / PROFILES	118
ΕΞΑΡΤΗΜΑΤΑ / ACCESSORIES	122
ΠΙΣΤΟΠΟΙΗΤΙΚΑ / CERTIFICATES	126





CLS RAILINGS



40 mm

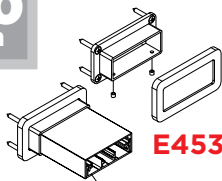

E4533Z

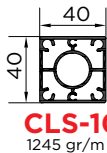

CLS-102
1245 gr/m

CLS-201
757 gr/m
FSN-221
754 gr/m

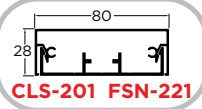
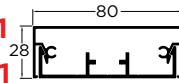

CLS-201 FSN-221

ΕΠΙΛΟΓΗ
ΚΑΘΕΤΟΥ
ΠΡΟΦΙΛ
SELECTION
OF VERTICAL
PROFILE

CLS E1

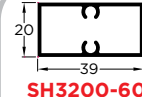

SH3200-601

CLS G1

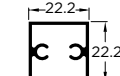

SH3200-635

CLS F1



CLS-304

CLS H1

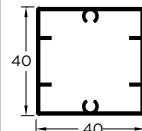

F50-106

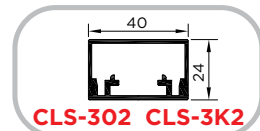

CLS-302 CLS-3K2

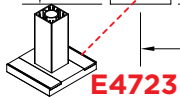
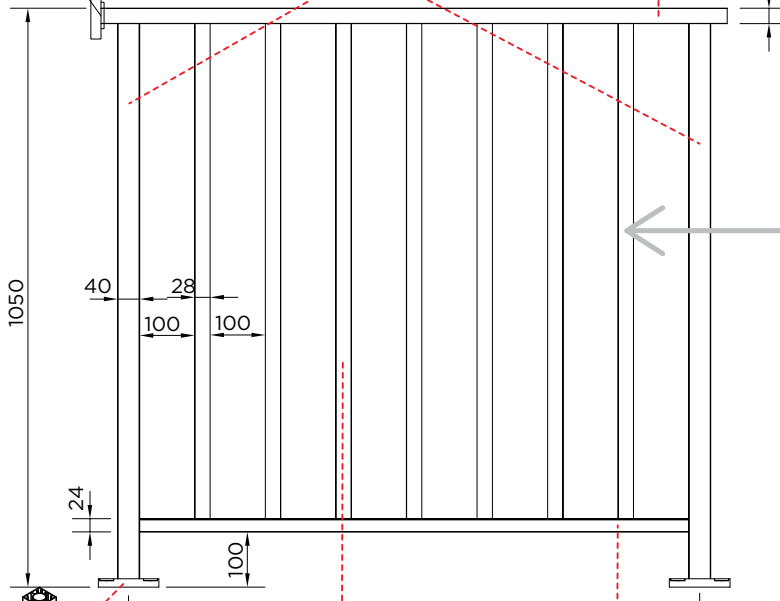

E4723

CLS-102

CLS-304
389 gr/m

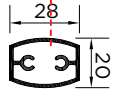

CLS-302
359 gr/m
CLS-3K2
324 gr/m

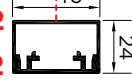

40 mm

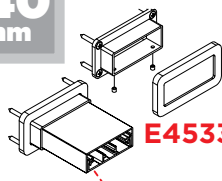

E4533Z

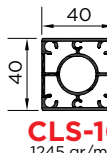

CLS-102
1245 gr/m



CLS-201
757 gr/m
FSN-221
754 gr/m



CLS-302
359 gr/m
CLS-3K2
324 gr/m

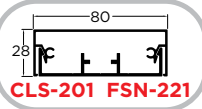

CLS-201 FSN-221

ΕΠΙΛΟΓΗ
ΚΑΘΕΤΟΥ
ΠΡΟΦΙΛ
SELECTION
OF VERTICAL
PROFILE

CLS E2

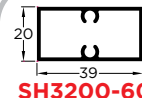

SH3200-601

CLS G2

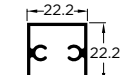

SH3200-635

CLS F2



CLS-304

CLS H2

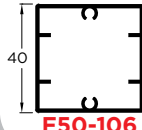

F50-106

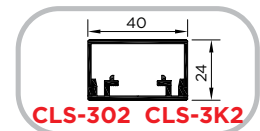

CLS-302 CLS-3K2

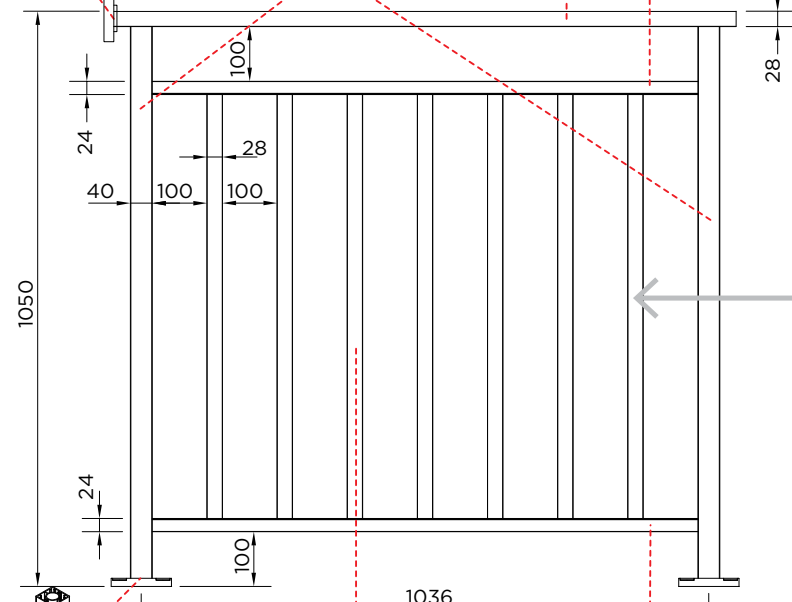

E4723

CLS-102

CLS-304
389 gr/m

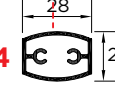

CLS-302
359 gr/m
CLS-3K2
324 gr/m

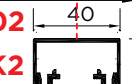

80 mm

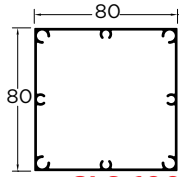

CLS-100
1606 gr/m

CLS-201
757 gr/m
FSN-221
754 gr/m

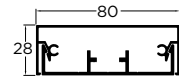

CLS-201 FSN-221

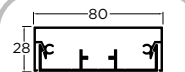

ΕΠΙΛΟΓΗ ΚΑΘΕΤΟΥ ΠΡΟΦΙΛ
SELECTION OF VERTICAL PROFILE

CLS C1

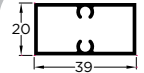

SH3200-601

CLS D1

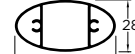

FSN 304

CLS B1



FSN 302

CLS A1

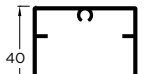

F50-106



CLS-301 CLS-3K1

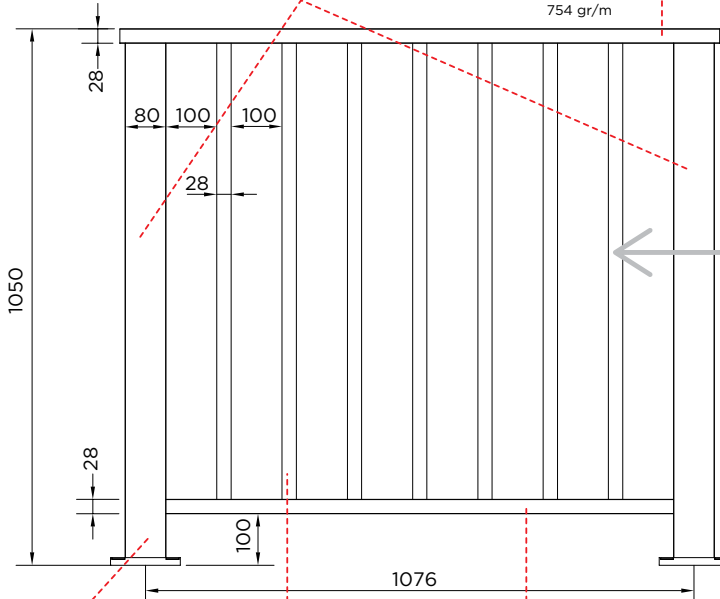

CLS-100

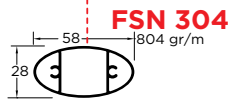

FSN 304
1804 gr/m

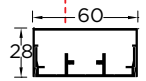

CLS-301
359 gr/m
CLS-3K1
324 gr/m

80 mm

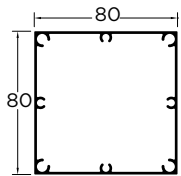

CLS-100
1606 gr/m

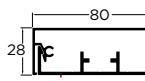

CLS-201
757 gr/m
FSN-221
754 gr/m

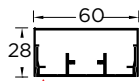

CLS-301
359 gr/m
CLS-3K1
324 gr/m

CLS-201 FSN-221

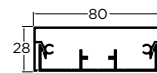

ΕΠΙΛΟΓΗ ΚΑΘΕΤΟΥ ΠΡΟΦΙΛ
SELECTION OF VERTICAL PROFILE

CLS C2

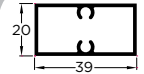

SH3200-601

CLS B2

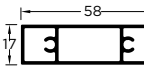

FSN-302

CLS D2



FSN-304

CLS A2

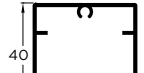

F50-106

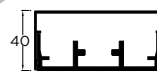

CLS-301 CLS-3K1

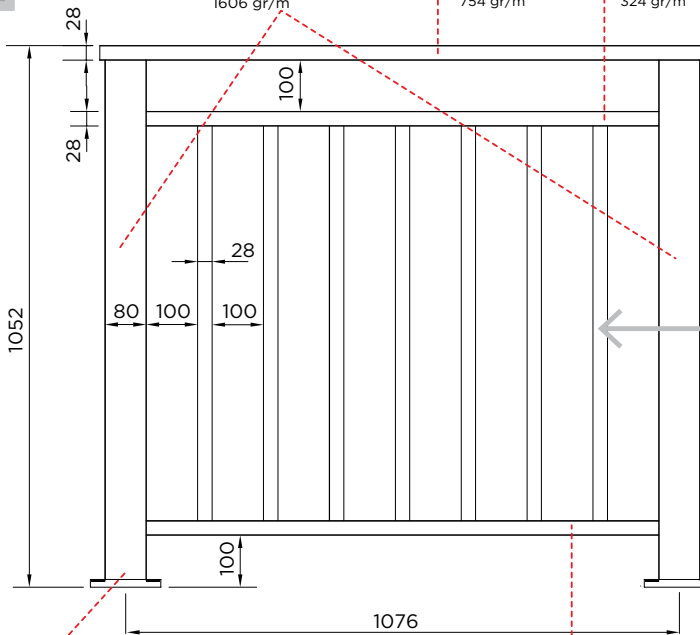

CLS-100

CLS-301
359 gr/m
CLS-3K1
324 gr/m

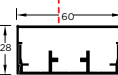

CLS RAILINGS



CLS WAVE 1

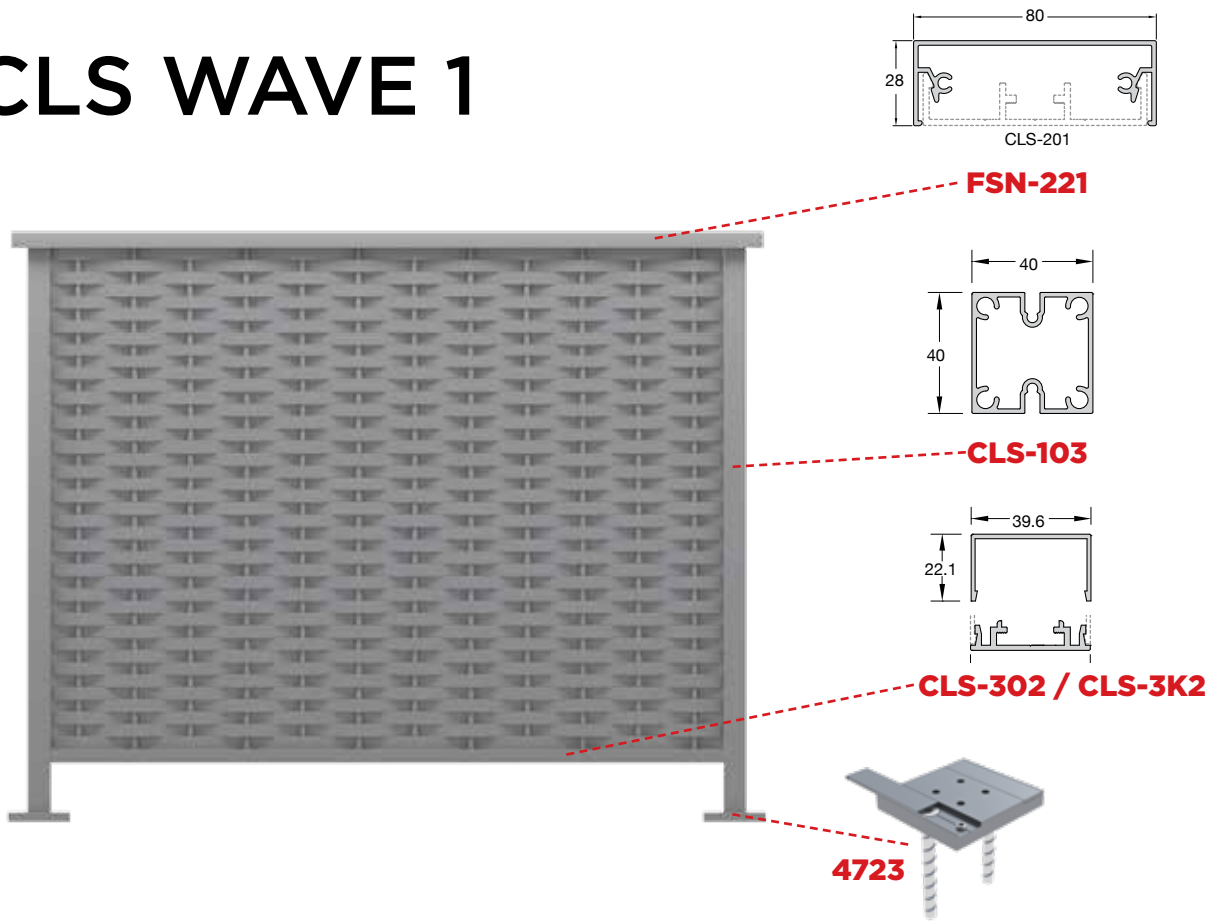

CLS WAVE 2

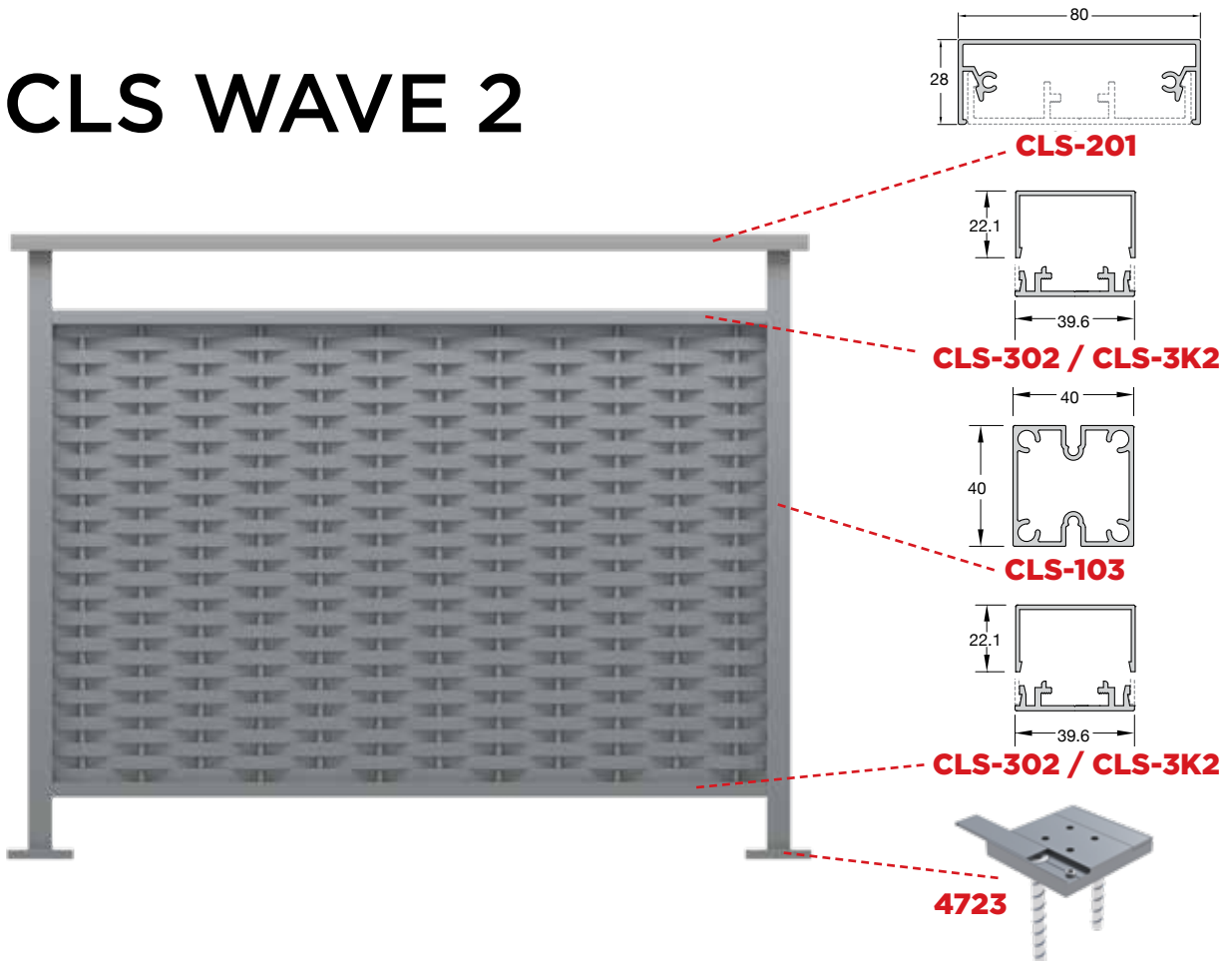

CLS RAILINGS

ΠΕΛΜΑΤΑ / SUPPORT FOOT

4723

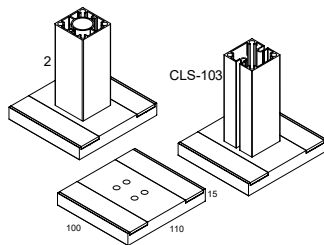
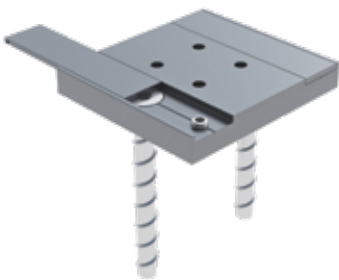

ΠΕΛΜΑ ΣΤΗΡΙΞΗΣ
ΚΟΛΩΝΑΣ CLS-102
SUPPORT FOOT FOR
COLUMN CLS-102

4741/4721

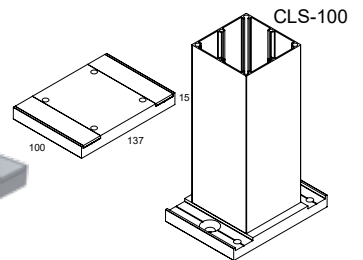
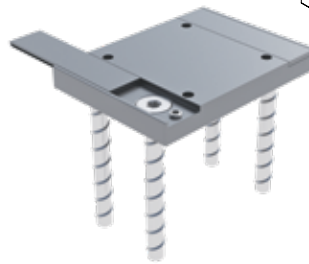

ΠΕΛΜΑ ΣΤΗΡΙΞΗΣ ΚΟΛΩΝΑΣ CLS-100
ΜΕ 2 Ή ΜΕ 4 ΒΙΔΕΣ
SUPPORT FOOT FOR COLUMN CLS-100
WITH 2 OR 4 CONCRETE SCREWS



PSATHA

Τα κλασικά κάγκελα αλουμινίου της σειράς PSATHA συνδυάζουν την ανθεκτικότητα και τη λειτουργικότητα του αλουμινίου, αποτελώντας μια ιδανική λύση για οικιακούς και επαγγελματικούς χώρους.

Η ψάθα αποτελείται από προφίλ αλουμινίου, τα οποία ως ένα σώμα ενσωματώνονται με συρόμενη εφαρμογή σε ειδικούς οδηγούς από αλουμίνιο, τοποθετημένους στο άνω και κάτω μέρος για βέλτιστη σταθερότητα και αντοχή.

Αυτός ο σχεδιασμός προσφέρει ευκολία στην τοποθέτηση και προσαρμογή σε κάθε είδους αρχιτεκτονική, προσφέροντας ταυτόχρονα ασφάλεια και υψηλή αισθητική ενώ εγγυάται μακροχρόνια χρήση με ελάχιστη συντήρηση.

The classic aluminum railings of the PSATHA series combine the durability and functionality of aluminum, making them an ideal solution for both residential and commercial spaces.

The PSATHA consists of aluminum profiles, which as one body are integrated with a sliding application into special tracks placed at the top and bottom for optimal stability and strength.

This design ensures ease of installation and adaptability to all types of architectural styles, while offering both safety and high aesthetic value. It also guarantees long-term use with minimal maintenance.

Η ψάθα αποτελείται από στοιχεία αλουμινίου, συρταρωμένα σε οδηγό πάνω και κάτω.

Ψάθα τοποθετείται ΜΟΝΟ σε ευθεία

Psatha consists of aluminium elements that slide on top and bottom guides.

Psatha can ONLY be placed on level surfaces

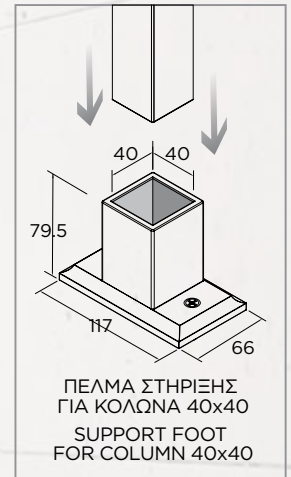
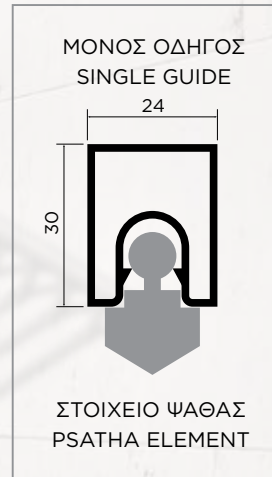
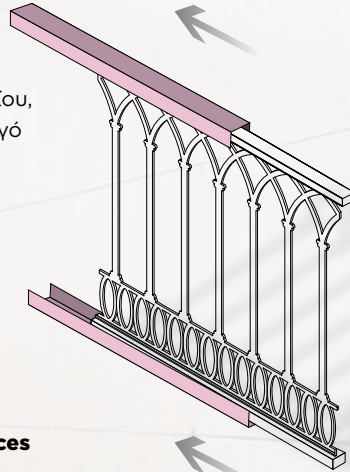

PSATHA

ZEFYROS A

ΥΨΟΣ ΚΑΓΚΕΛΟΥ / RAILING HEIGHT
ΑΠΟ/**FROM** 90 ΕΩΣ/**UPTO** 110 CM

ΨΑΘΑ / **PSATHA**
ΜΗΚΟΣ / **LENGTH** 192 CM



80-29

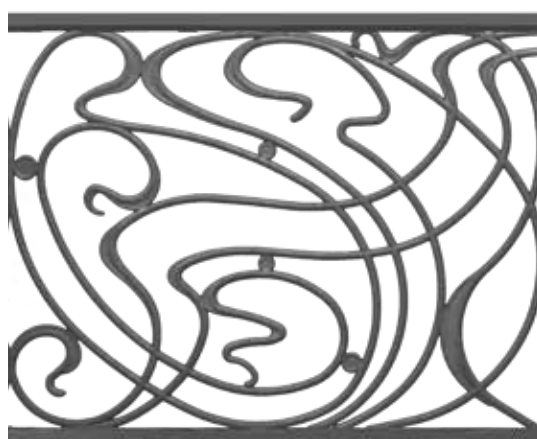

80 cm

96 cm

ZEFYROS B

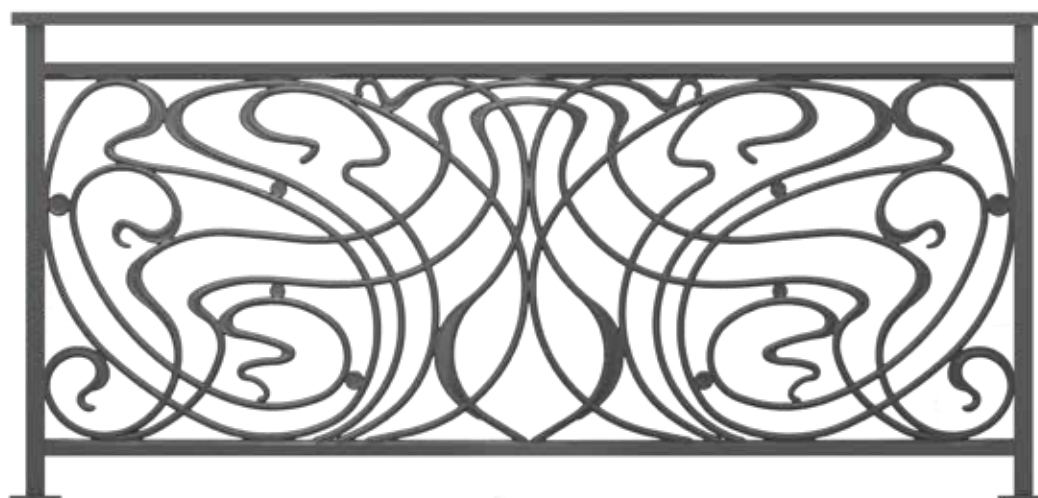

PSATHA



PSATHA

ATHENIAN

ΥΨΟΣ ΚΑΓΚΕΛΟΥ / **RAILING HEIGHT**
ΑΠΟ/**FROM 30** ΕΩΣ/**UPTO 100** CM

ΨΑΘΑ / PSATHA
ΜΗΚΟΣ / **LENGTH** 480 CM
(96cm x 5)

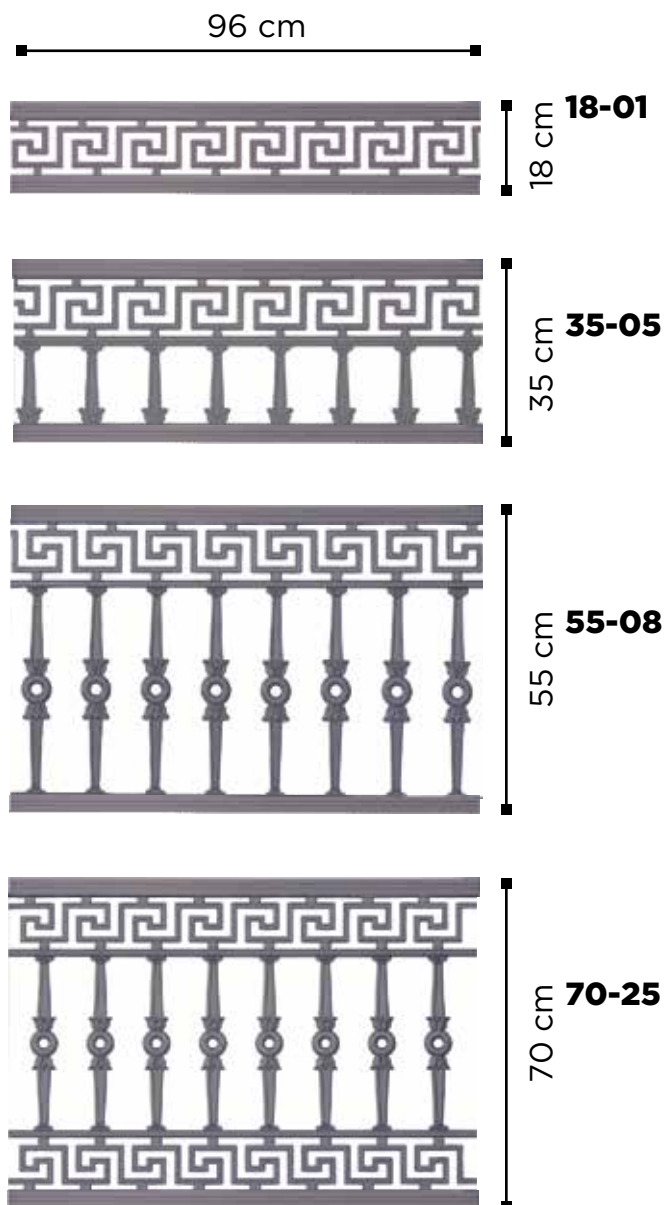
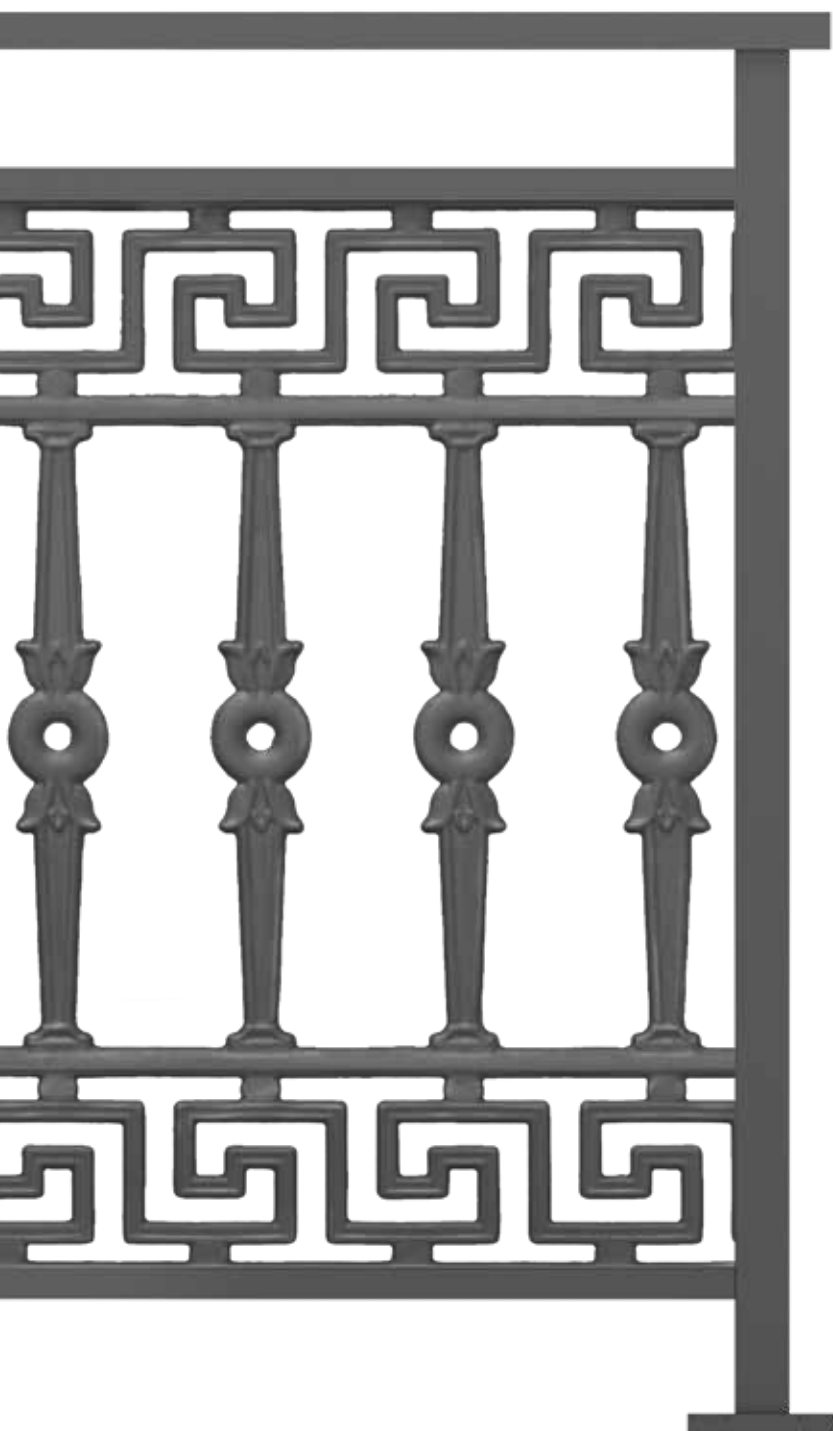

PSATHA



PSATHA

ASTERI A

ΨΑΘΑ / PSATHA

ΜΗΚΟΣ / **LENGTH** 480 CM
(96cm x 5)

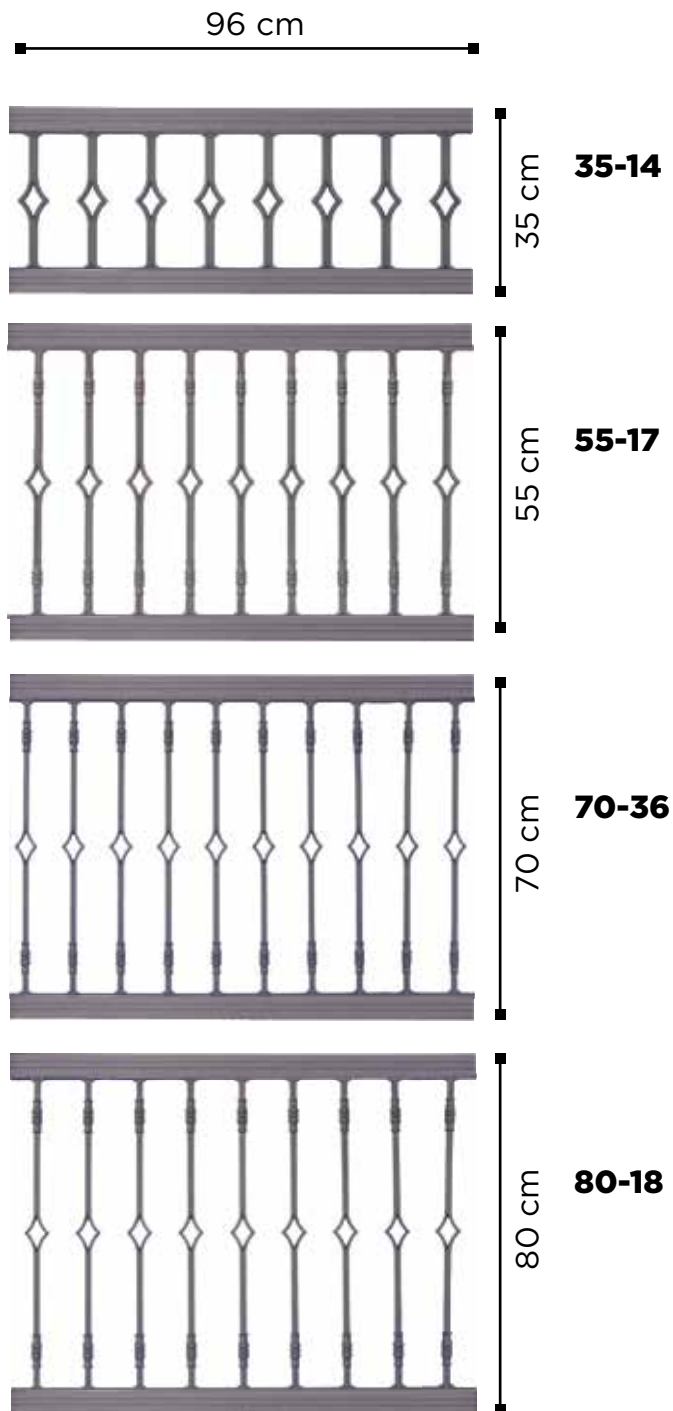

PSATHA



PSATHA

ASTERI B

ΨΑΘΑ / PSATHA

ΜΗΚΟΣ / **LENGTH** 480 CM
(96cm x 5)

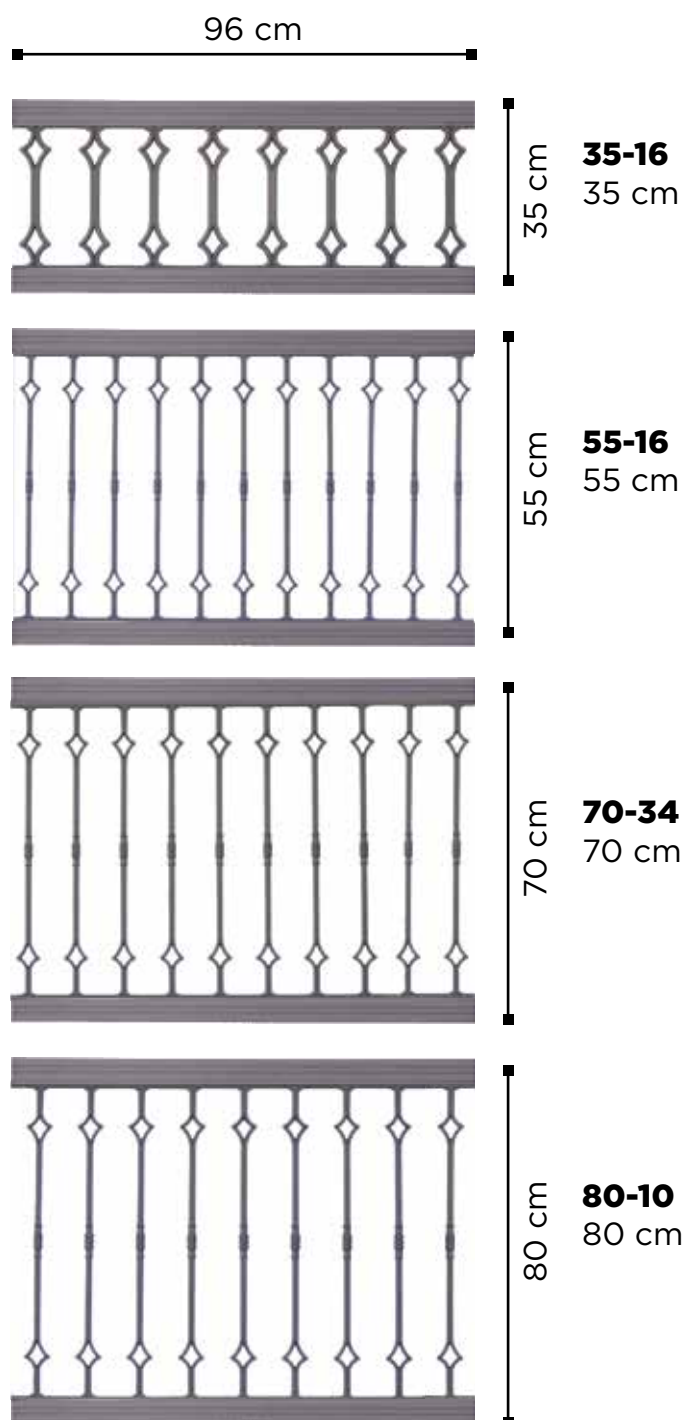
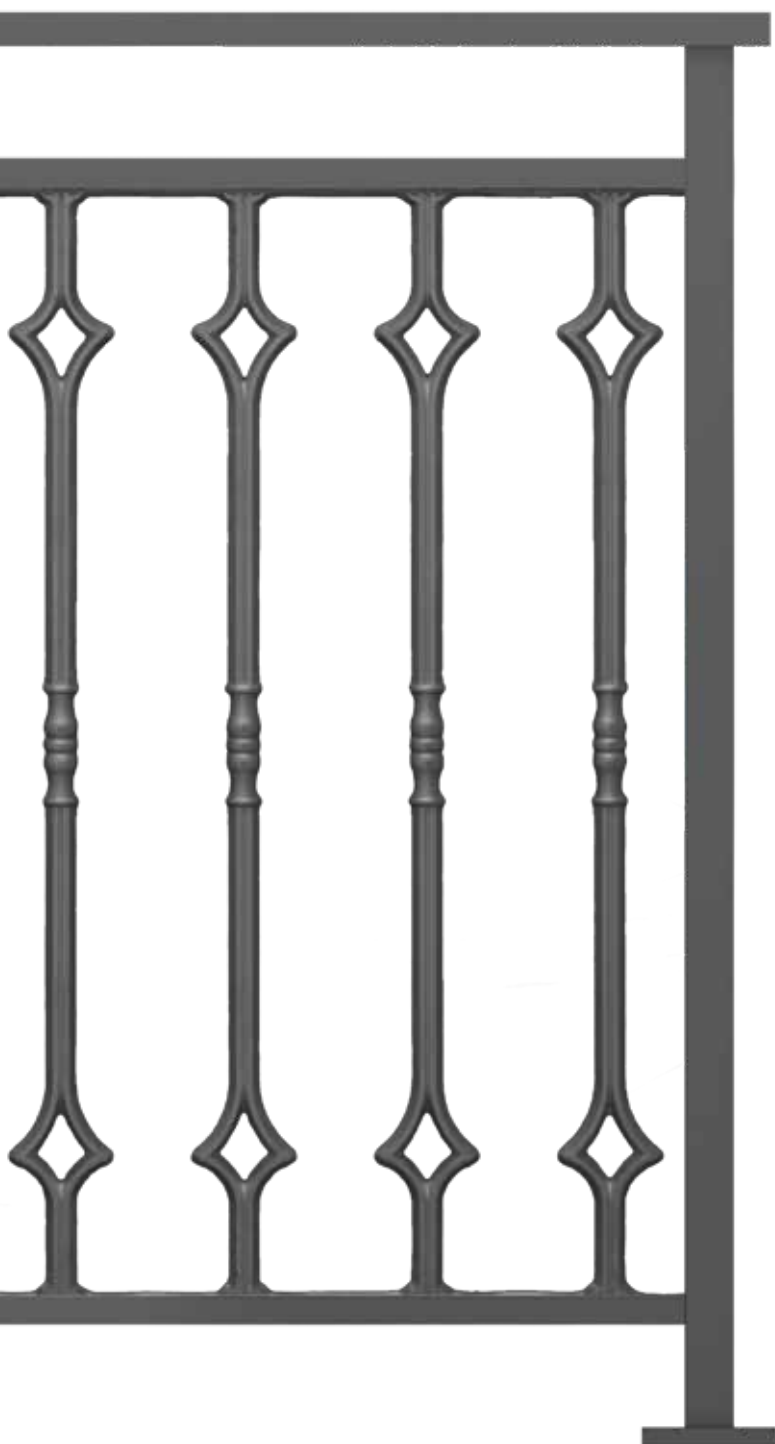

PSATHA



PSATHA

VIENNA

ΥΨΟΣ ΚΑΓΚΕΛΟΥ / **RAILING HEIGHT**
ΑΠΟ/**FROM 45 ΕΩΣ/ΥΠΤΟ 120 CM**

ΨΑΘΑ / PSATHA
ΜΗΚΟΣ / **LENGTH 480 CM**
(96cm x 5)

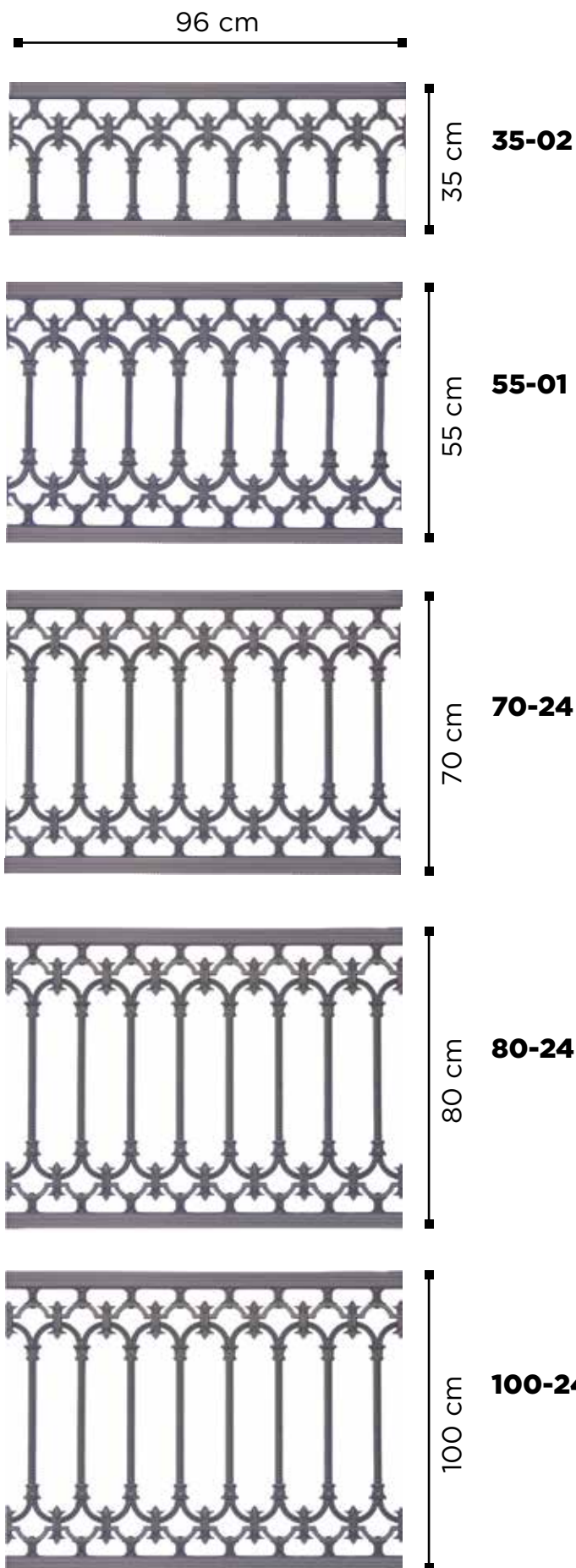
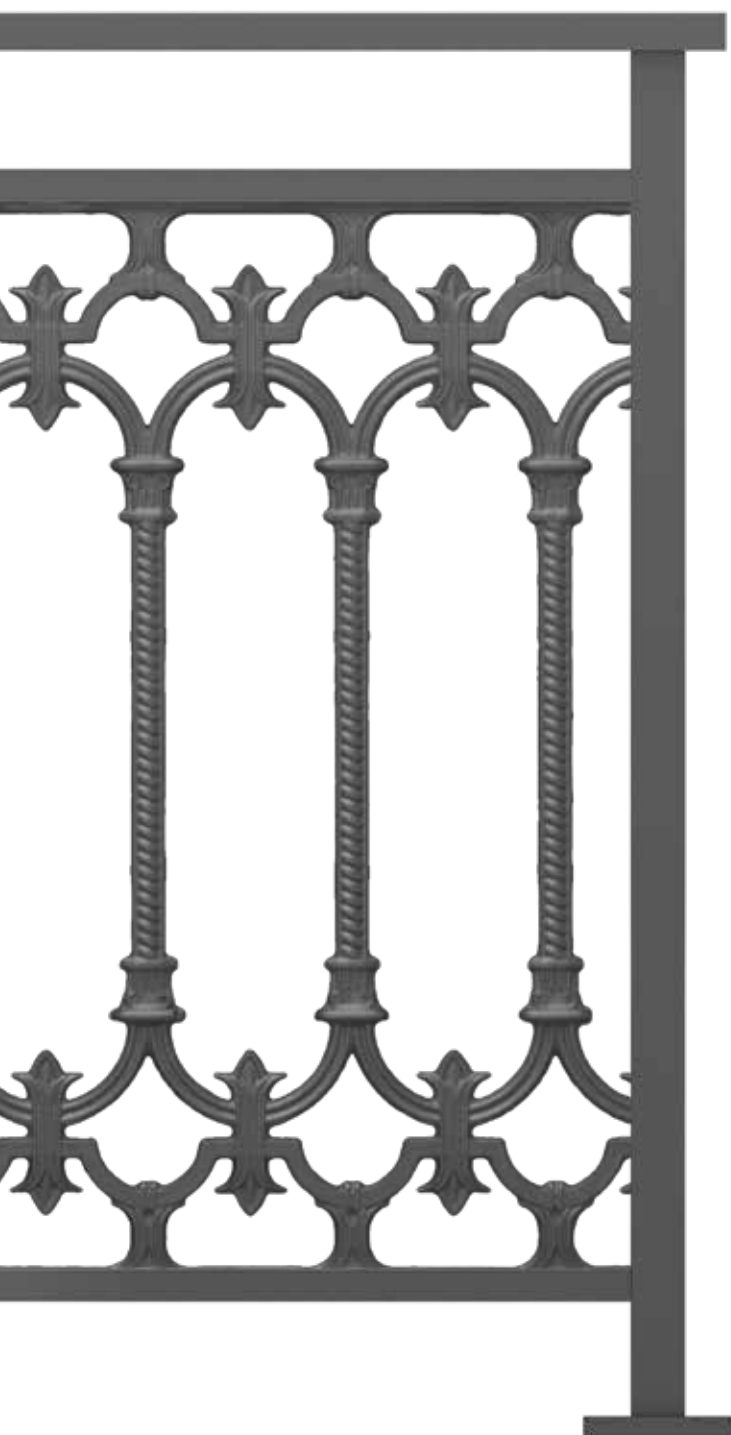

PSATHA



PSATHA

GOTHIC

ΥΨΟΣ ΚΑΓΚΕΛΟΥ / **RAILING HEIGHT**
ΑΠΟ/**FROM 30** ΕΩΣ/**UPTO 110** CM

ΨΑΘΑ / PSATHA
ΜΗΚΟΣ / **LENGTH** 480 CM
(96cm x 5)

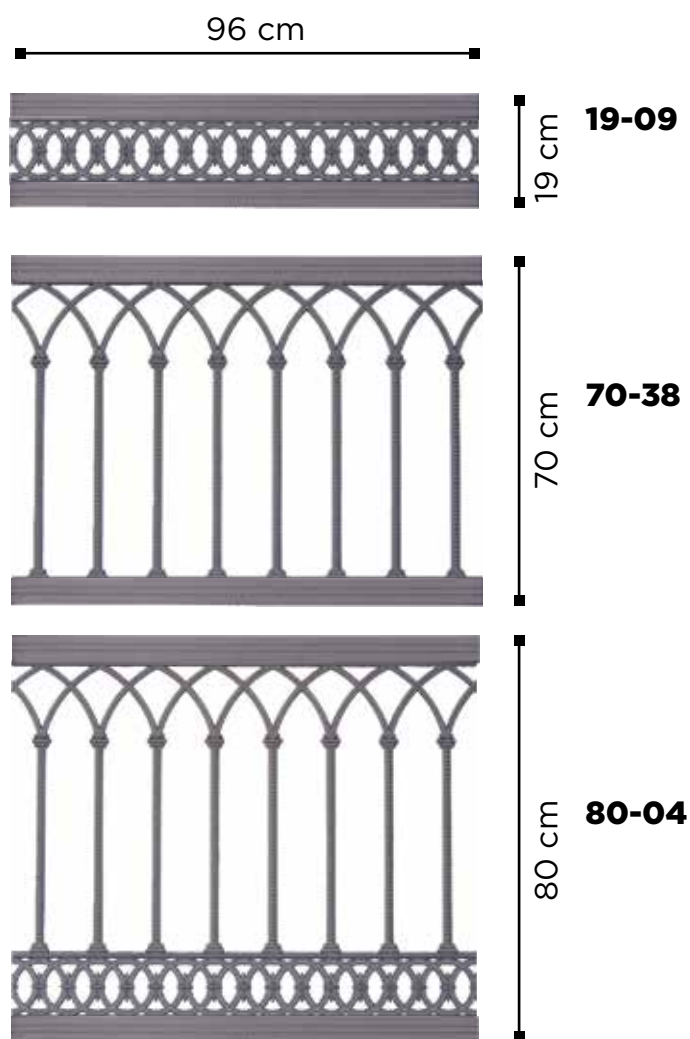
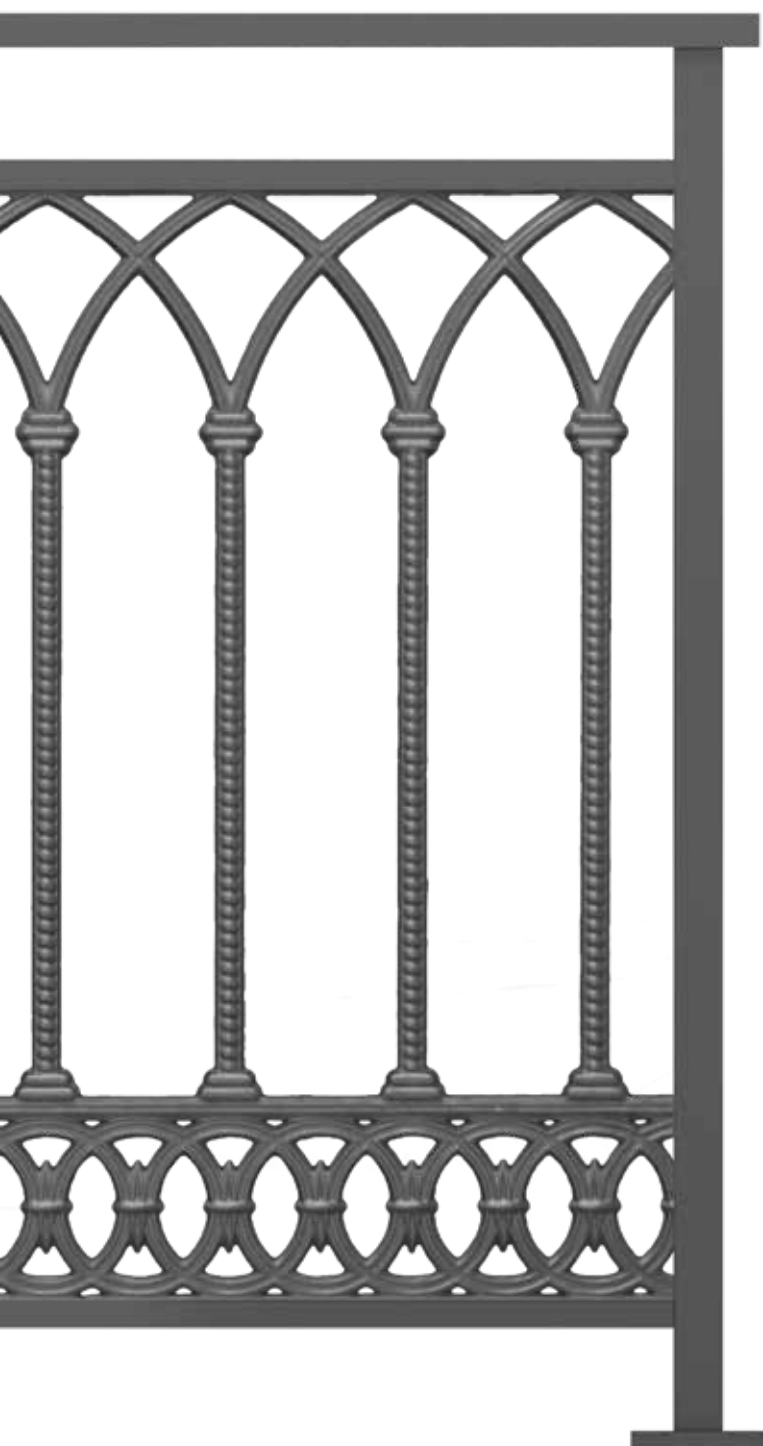



PSATHA

LINEAR

ΨΑΘΑ / PSATHA

ΜΗΚΟΣ / **LENGTH** 480 CM
(96cm x 5)

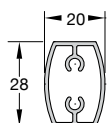

CLS-304

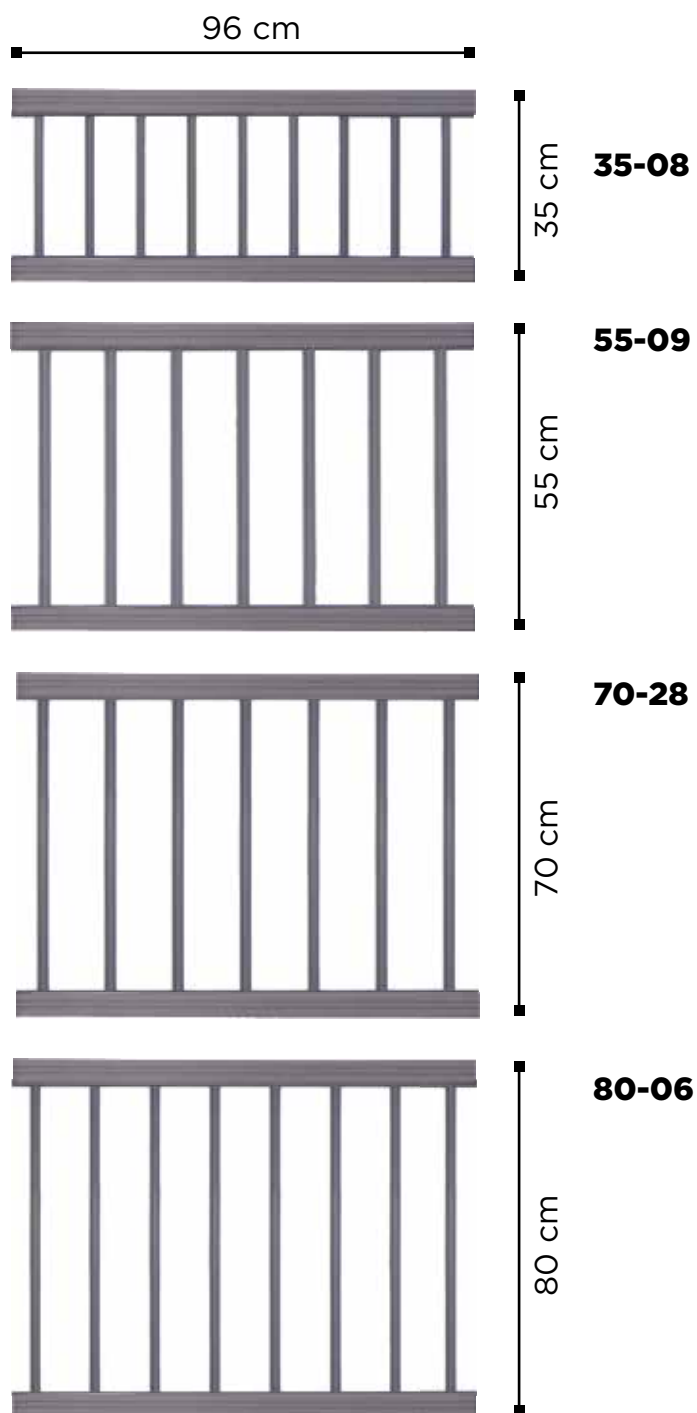
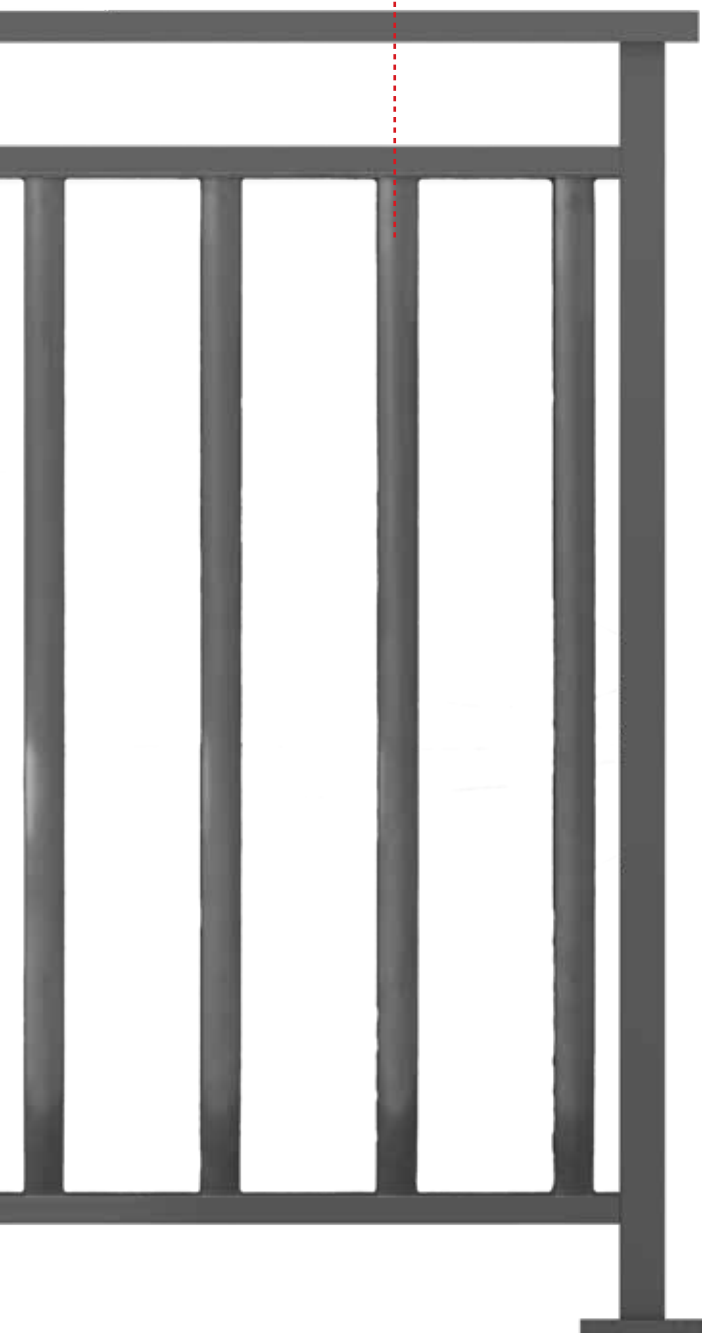

PSATHA



PSATHA

DORIC

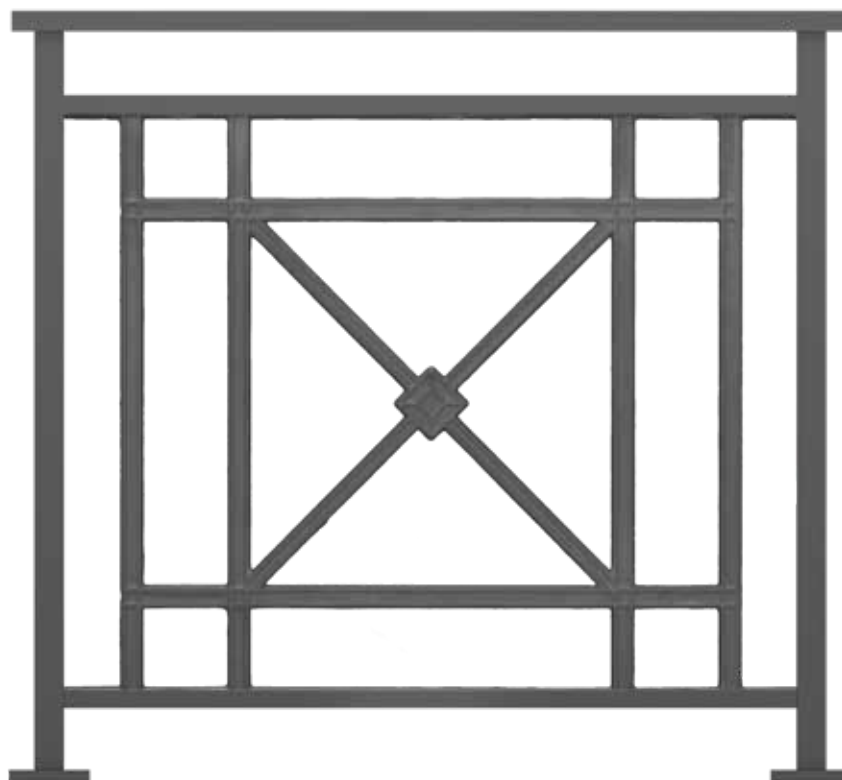

LINEAR

96 cm



70-10

DORIC

77 cm



70 cm

70-17

PSATHA



PSATHA

ΕΘΝΙΚΗΣ

ΥΨΟΣ ΚΑΓΚΕΛΟΥ / RAILING HEIGHT
ΑΠΟ/**FROM 30** ΕΩΣ/**ΥΠΤΟ 110** CM

ΨΑΘΑ / PSATHA
ΜΗΚΟΣ / **LENGTH 480** CM
(96cm x 5)

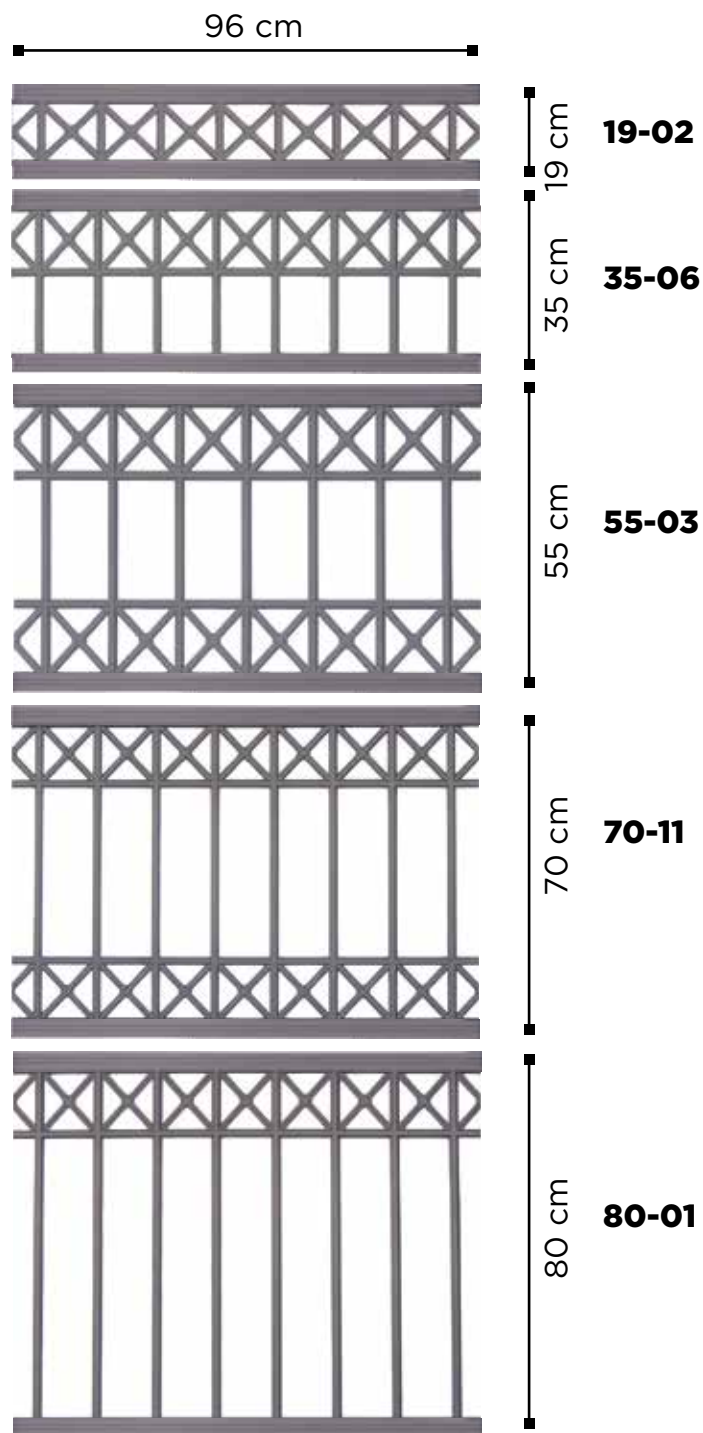
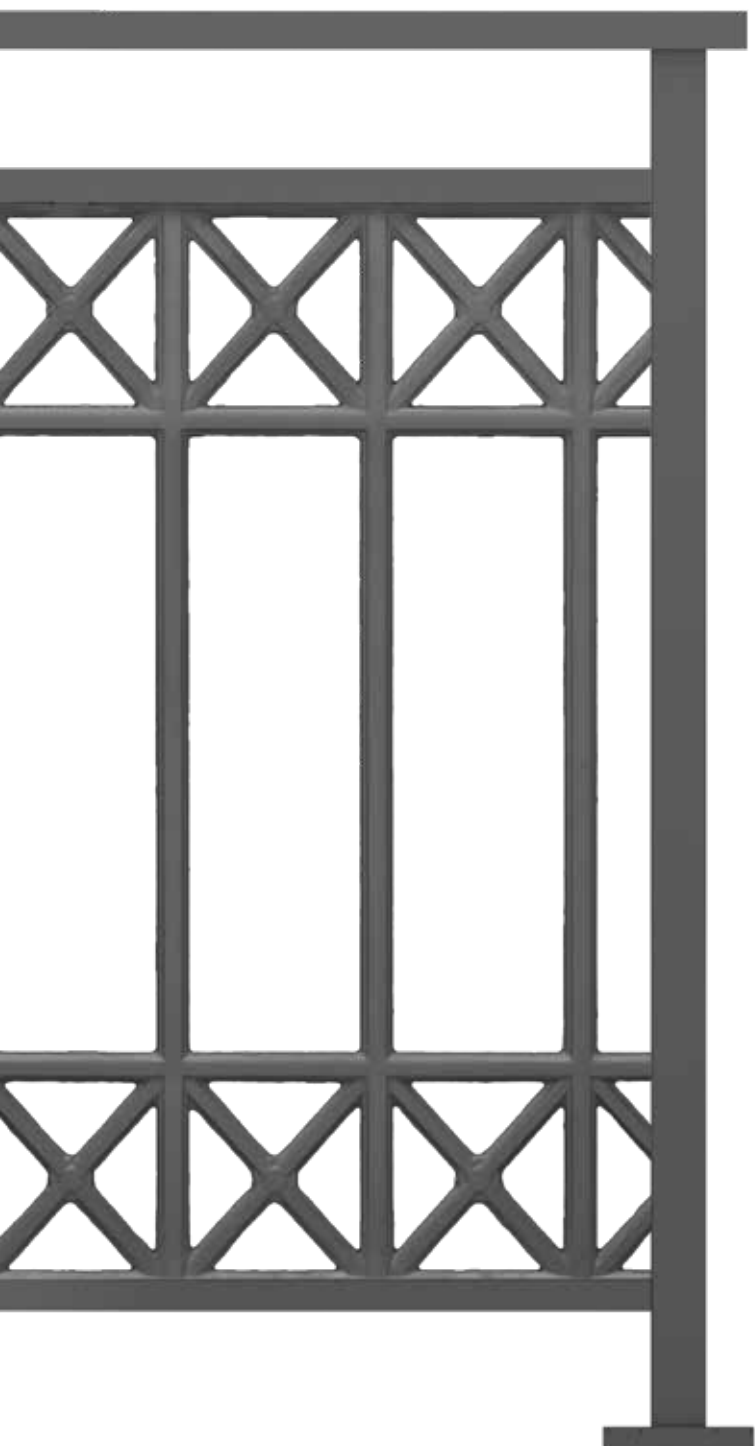

PSATHA



PSATHA

KAMARA

ΥΨΟΣ ΚΑΓΚΕΛΟΥ / **RAILING HEIGHT**
ΑΠΟ/**FROM 26** ΕΩΣ/**UPTO 100** CM

ΨΑΘΑ / PSATHA
ΜΗΚΟΣ / **LENGTH 480** CM
(96cm x 5)

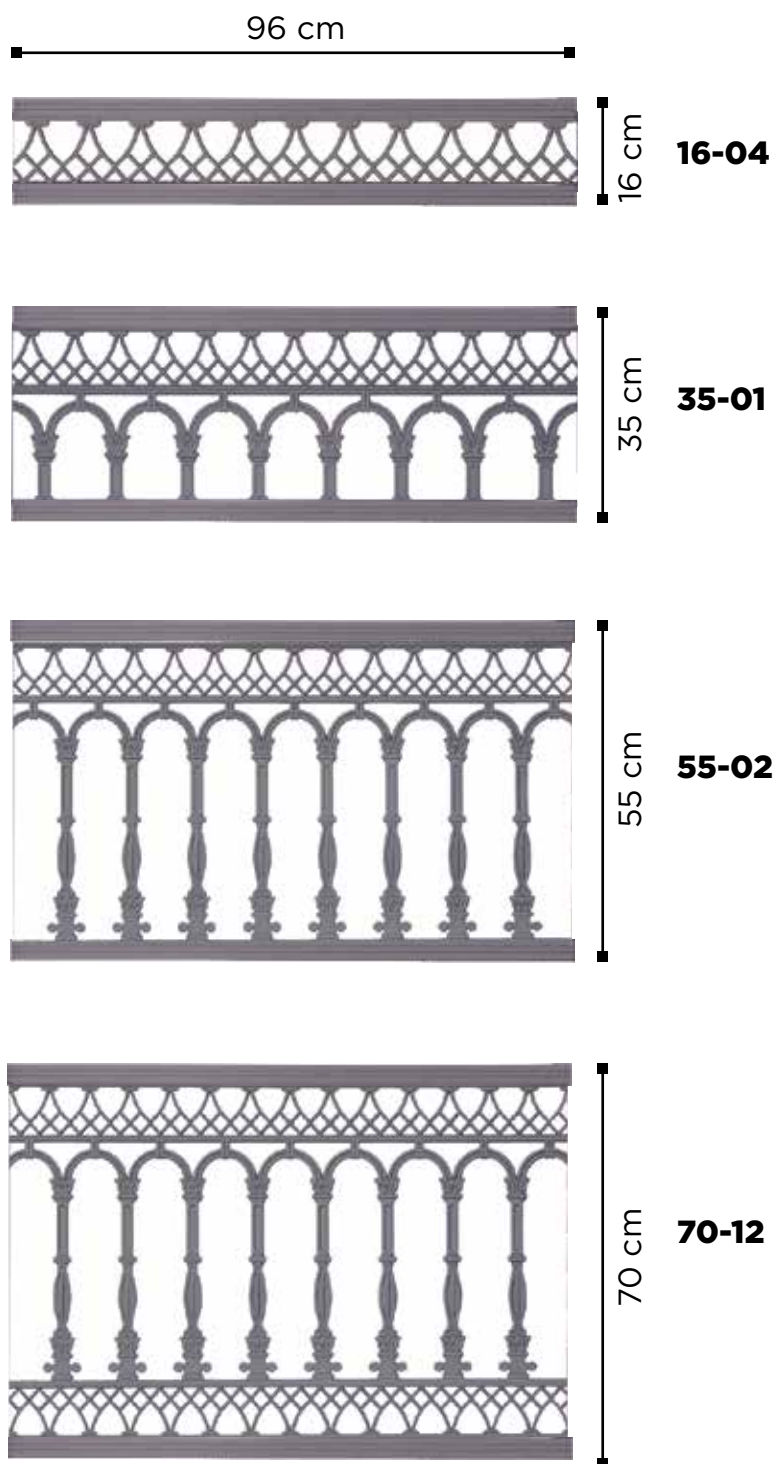
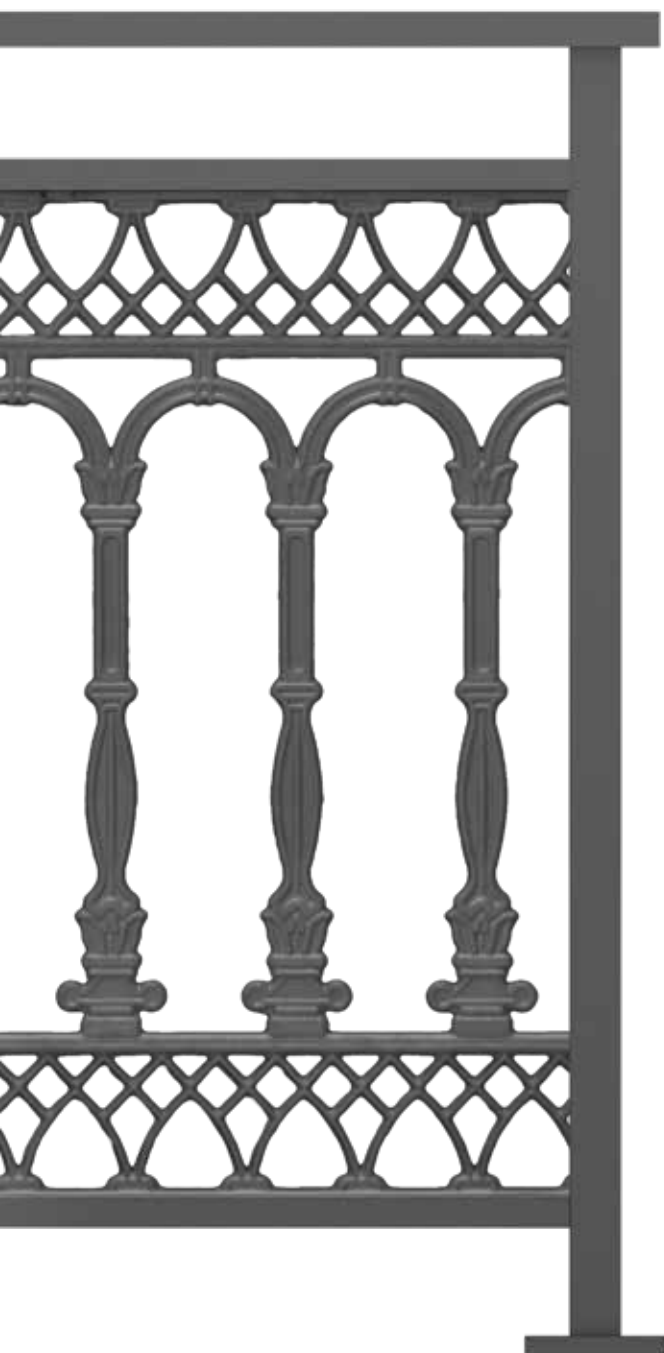

PSATHA



PSATHA

FOREST

ΥΨΟΣ ΚΑΓΚΕΛΟΥ / **RAILING HEIGHT**
ΑΠΟ/**FROM 110** ΕΩΣ/**UPTO 130** CM

ΨΑΘΑ / **PSATHA**
ΜΗΚΟΣ / **LENGTH 220** CM

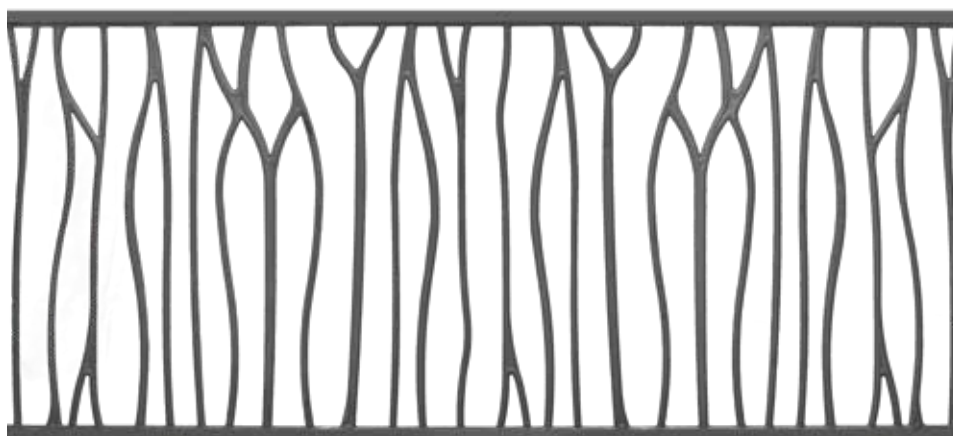

100 25

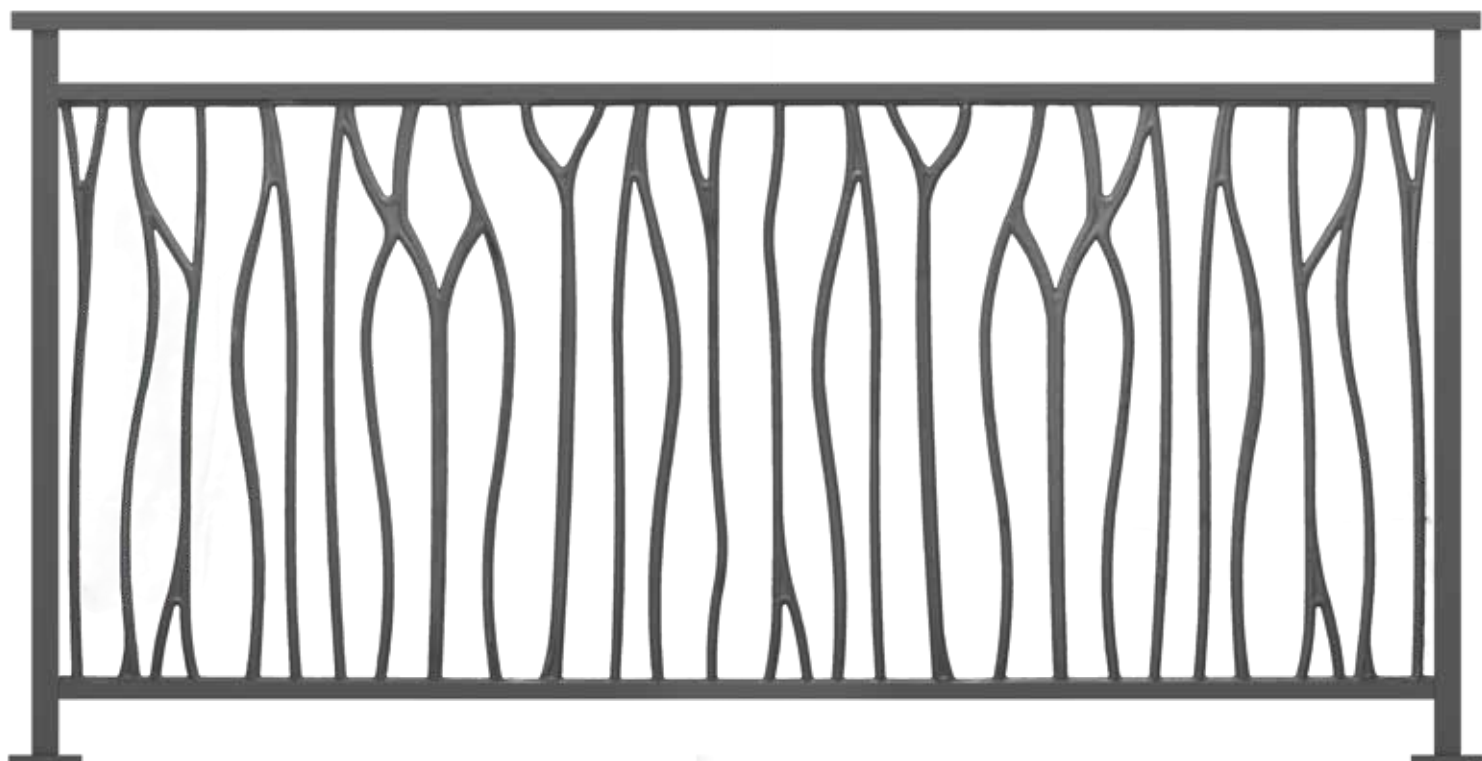



PSATHA

KOLONATO

ΥΨΟΣ ΚΑΓΚΕΛΟΥ / **RAILING HEIGHT**
ΑΠΟ/**FROM 24** ΕΩΣ/**UPTO 100** CM

ΨΑΘΑ / PSATHA
ΜΗΚΟΣ / **LENGTH 480** CM
(96cm x 5)

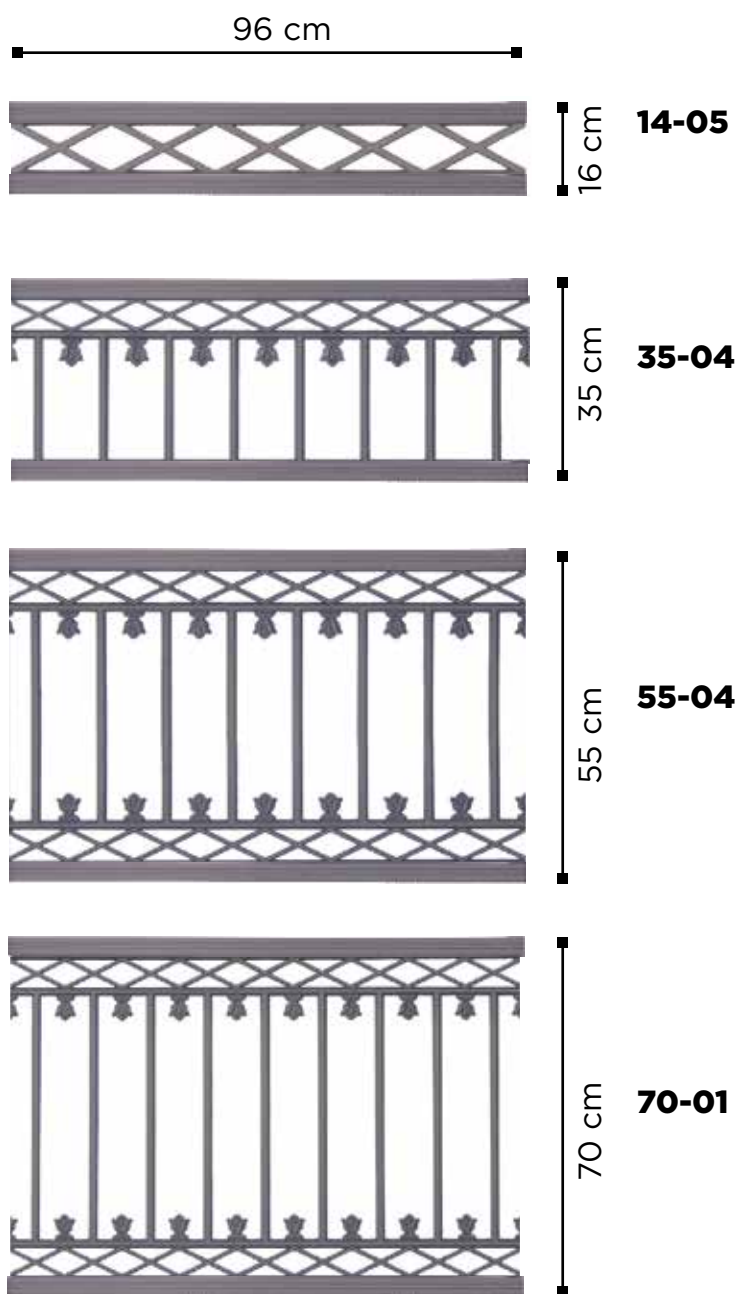
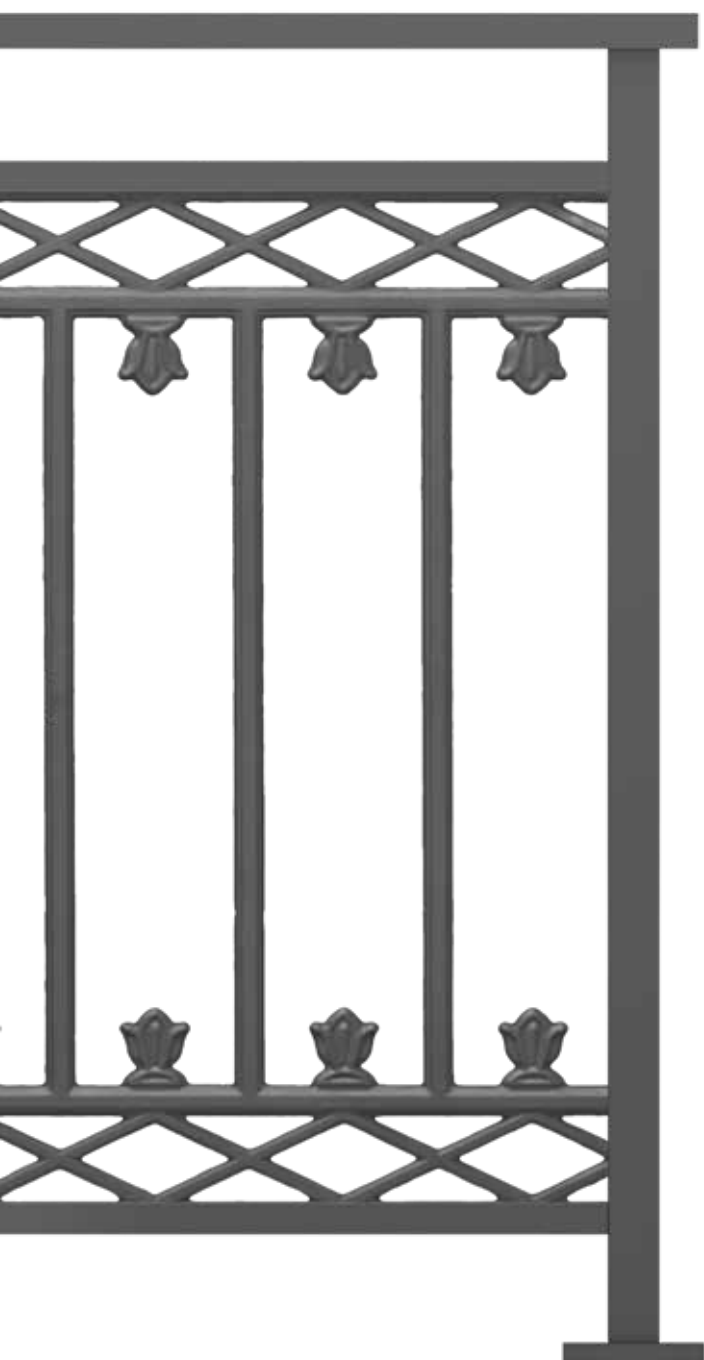

PSATHA



PSATHA

KYKLADITIKO

ΨΑΘΑ / PSATHA

ΜΗΚΟΣ / **LENGTH** 480 CM
(96cm x 5)

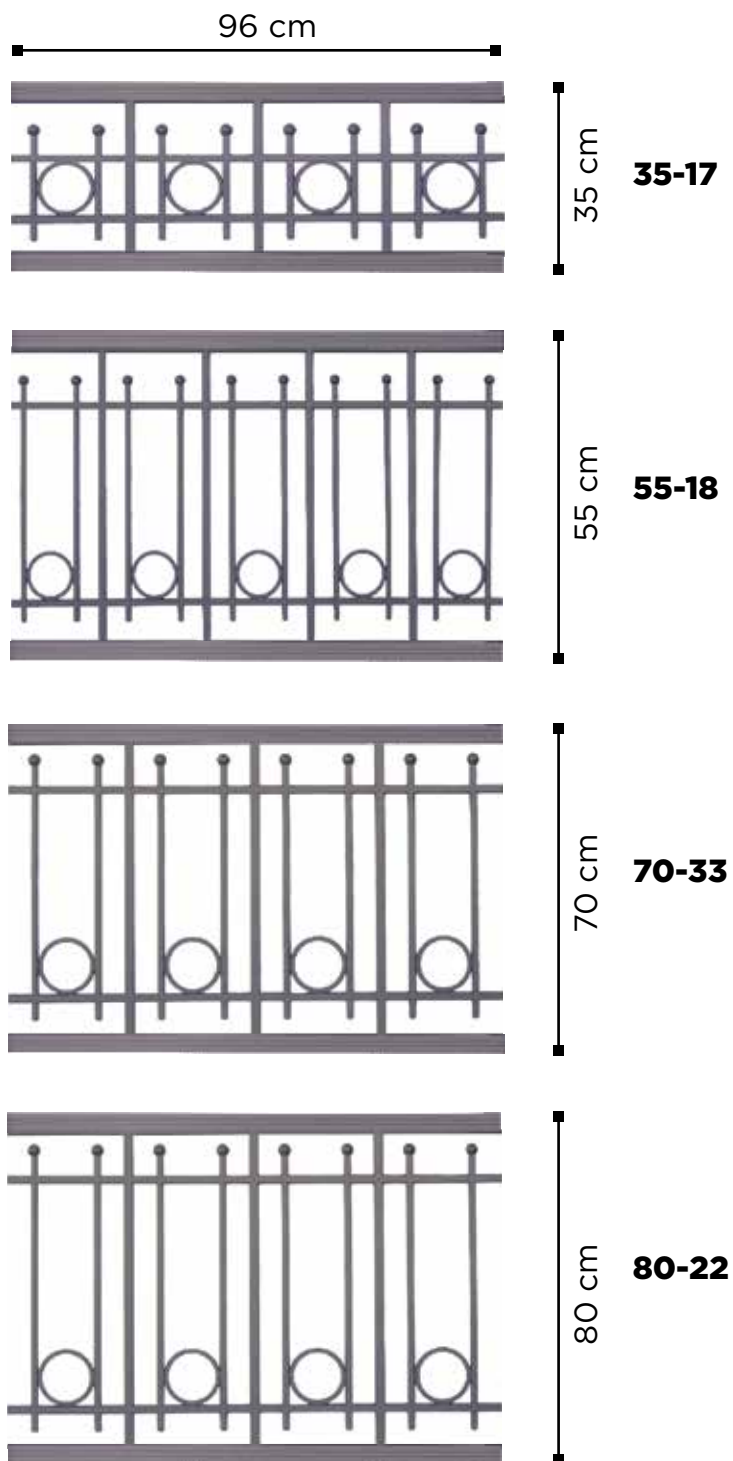
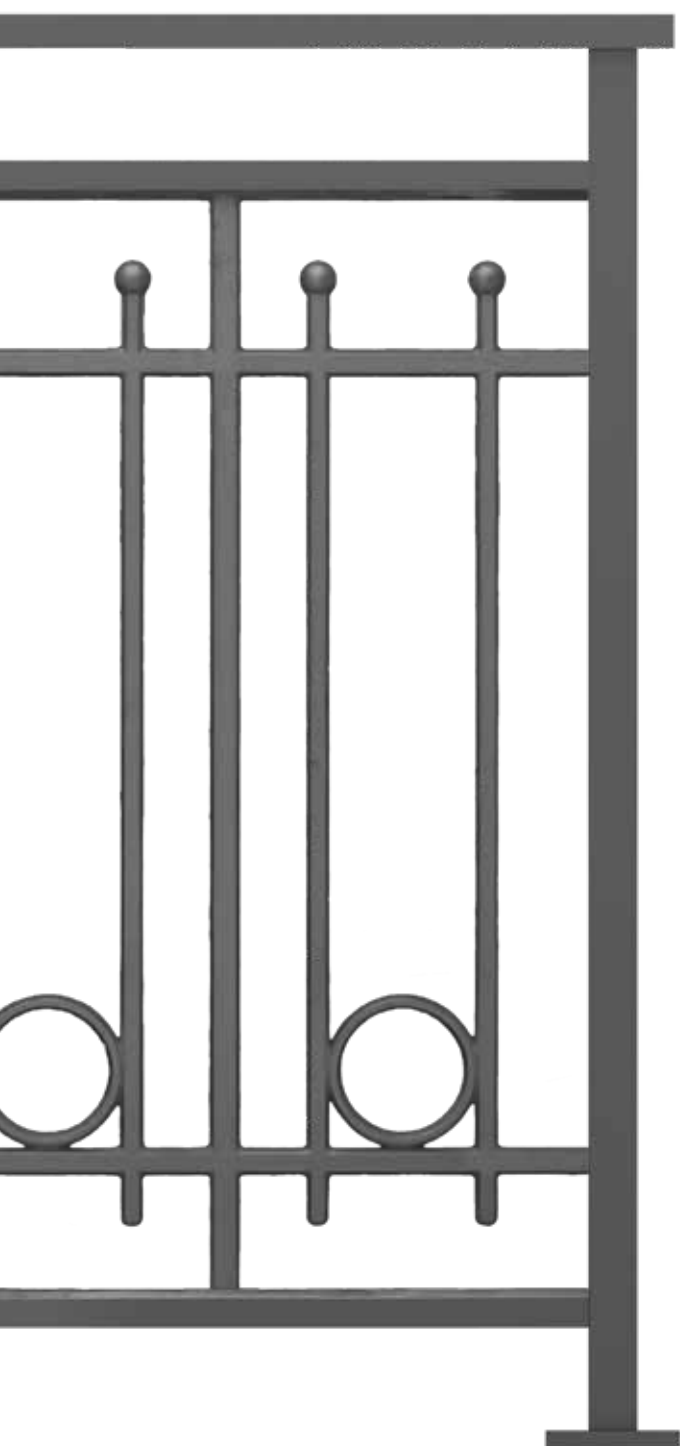

PSATHA



PSATHA

ΜΑΚΡΙΑΙΑΝΝΙ

ΥΨΟΣ ΚΑΓΚΕΛΟΥ / **RAILING HEIGHT**
ΑΠΟ/**FROM 30** ΕΩΣ/**UPTO 110** CM

ΨΑΘΑ / PSATHA
ΜΗΚΟΣ / **LENGTH 480** CM
(96cm x 5)

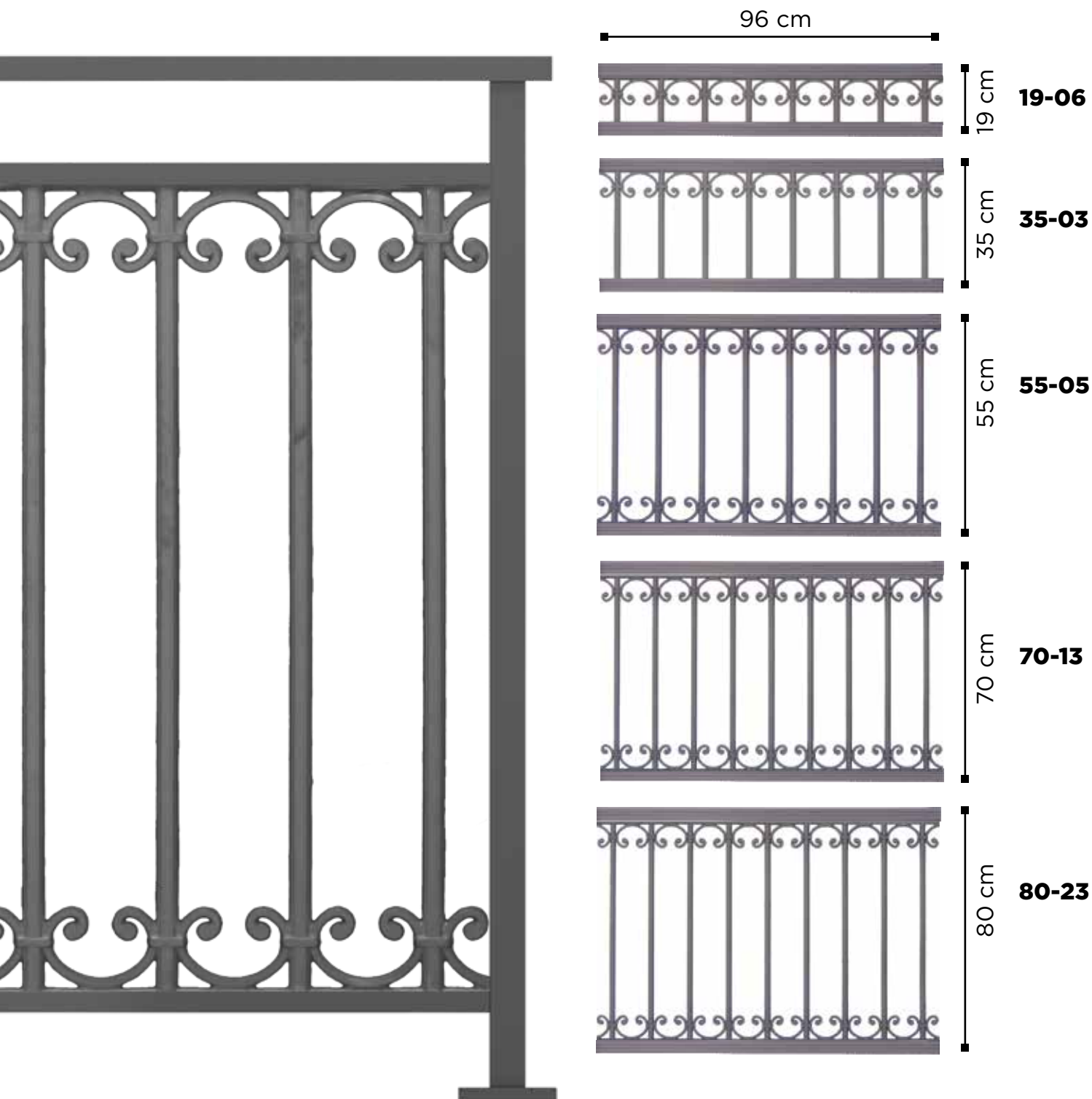

PSATHA



PSATHA

MINOAN

ΥΨΟΣ ΚΑΓΚΕΛΟΥ / **RAILING HEIGHT**
ΑΠΟ/**FROM 90** ΕΩΣ/**UPTO 110** CM

ΨΑΘΑ / PSATHA
ΜΗΚΟΣ / **LENGTH** 480 CM
(96cm x 5)

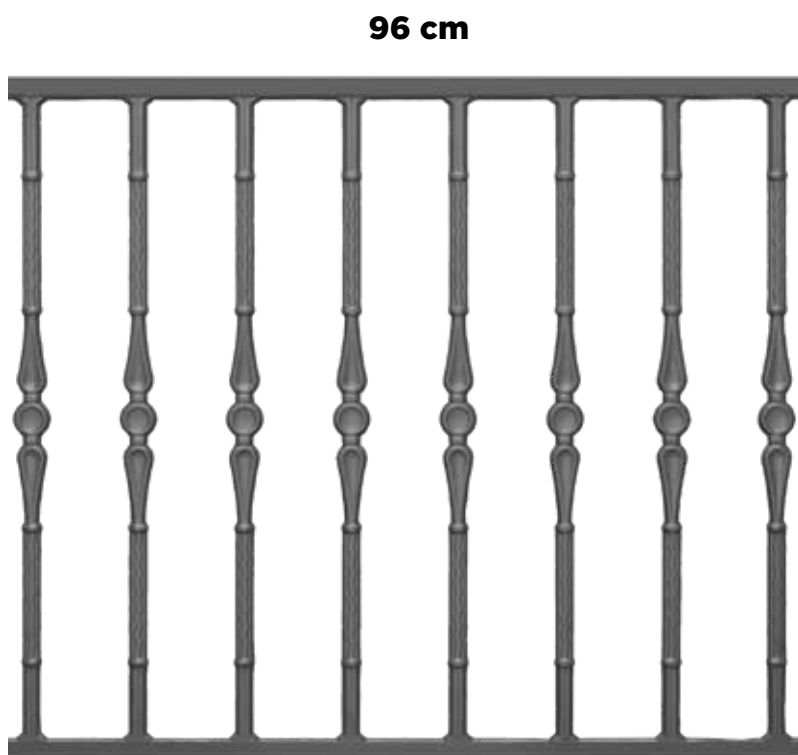
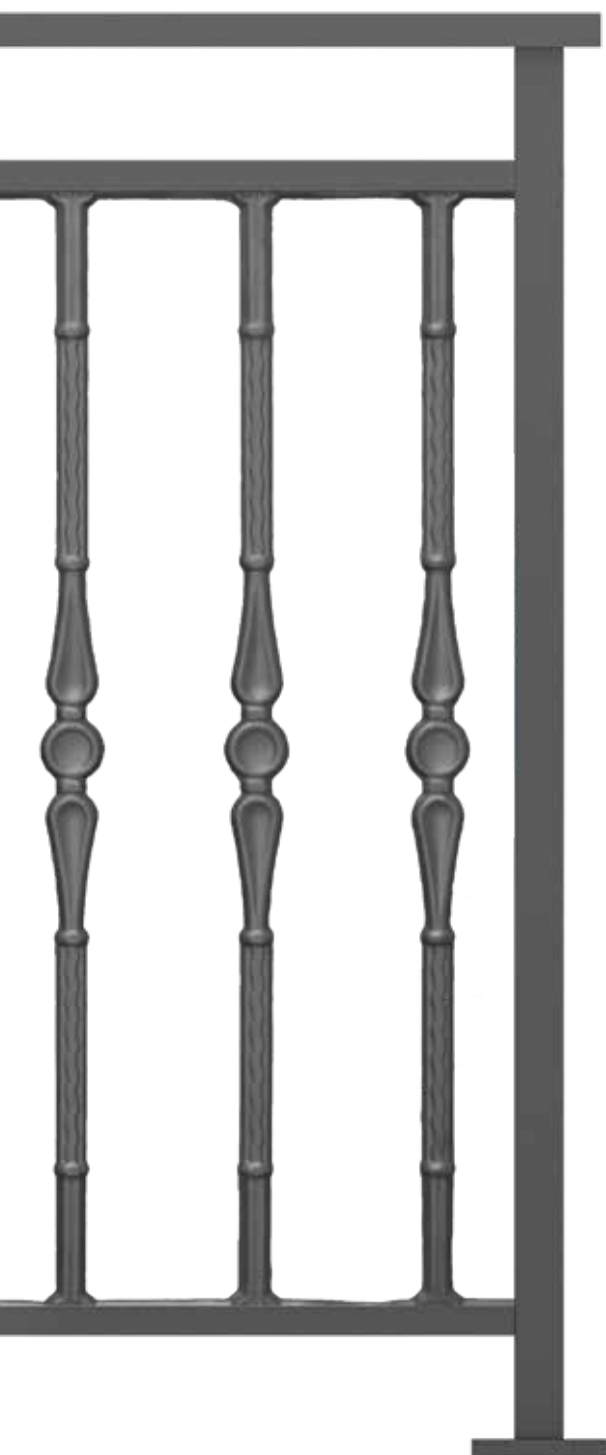

96 cm

80-11

PSATHA



PSATHA

PERIKOKLADA

ΥΨΟΣ ΚΑΓΚΕΛΟΥ / **RAILING HEIGHT**
ΑΠΟ/**FROM 80** ΕΩΣ/**UPTO 100** CM

ΨΑΘΑ / **PSATHA**
ΜΗΚΟΣ / **LENGTH 216** CM

55 cm



17 cm
ROSETA
17-07



70 cm
GLASTRA
70-21

108 cm



70-20

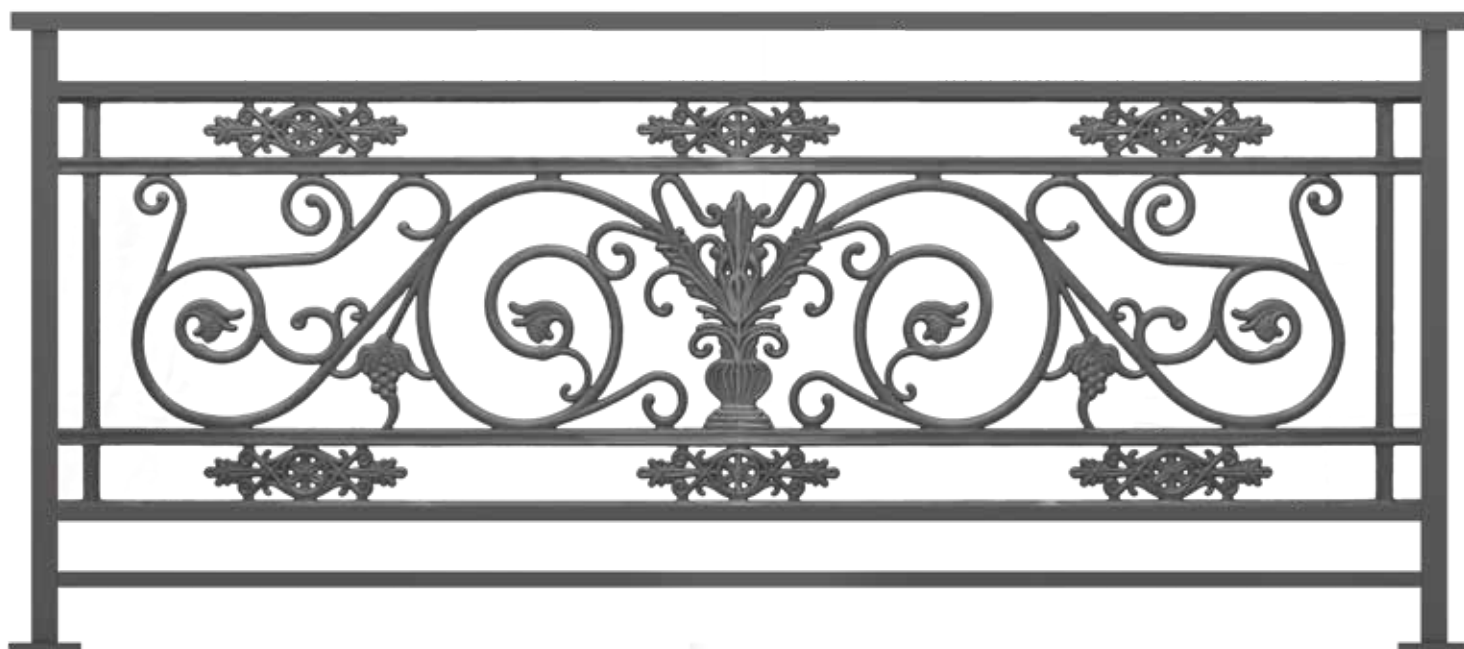

PSATHA



PSATHA

OLYMPIA

ΥΨΟΣ ΚΑΓΚΕΛΟΥ / **RAILING HEIGHT**
ΑΠΟ/**FROM 90** ΕΩΣ/**UPTO 100** CM

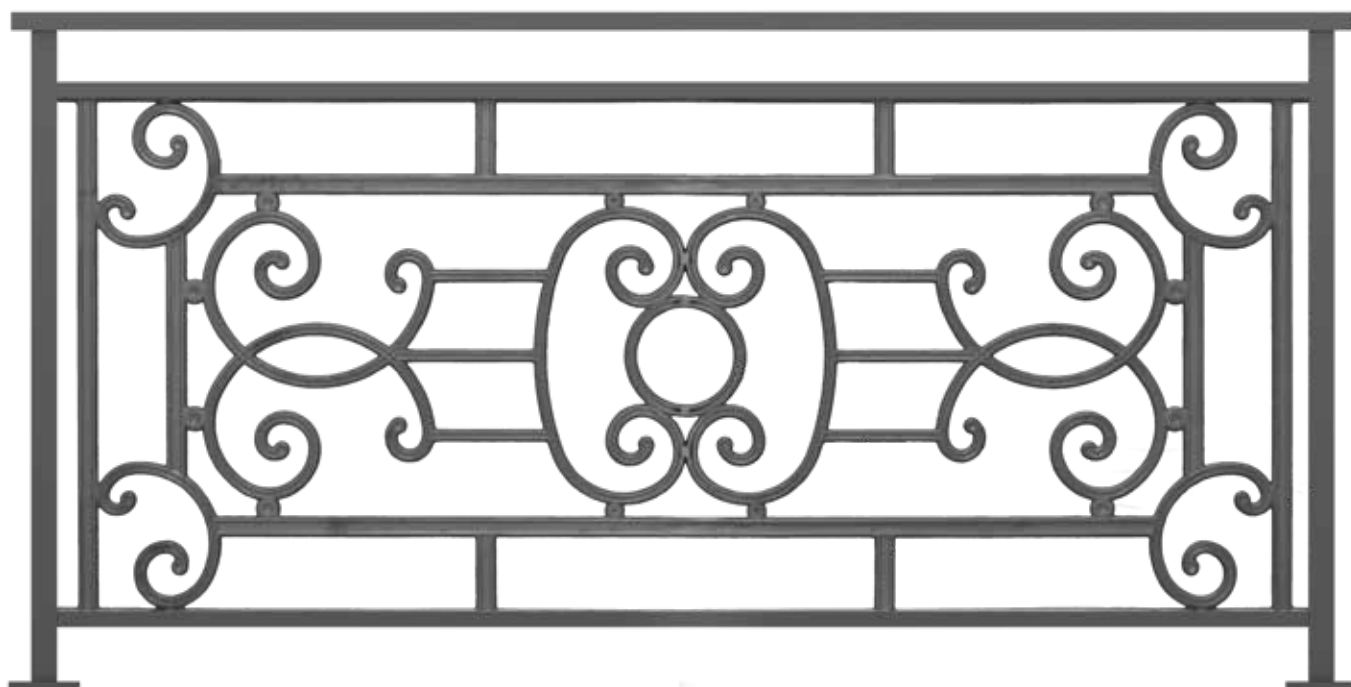
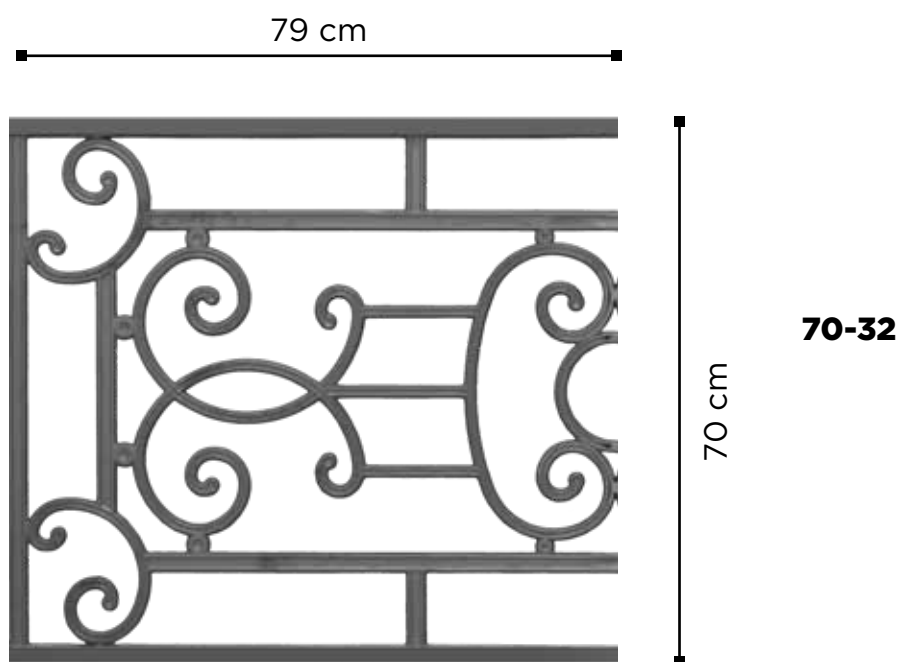

PSATHA



PSATHA

COLONIAN

ΥΨΟΣ ΚΑΓΚΕΛΟΥ / **RAILING HEIGHT**
ΑΠΟ/**FROM 90** ΕΩΣ/**UPTO 110** CM

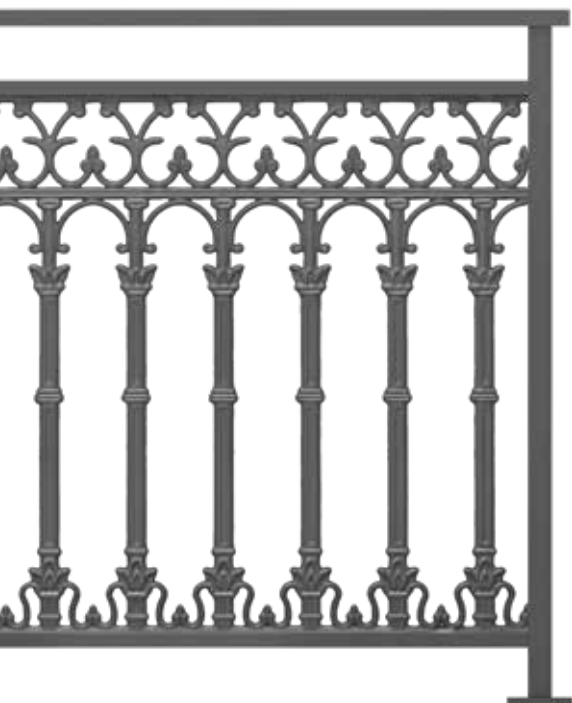

ΨΑΘΑ / PSATHA

ΜΗΚΟΣ / **LENGTH** 480 CM
(96cm x 5)

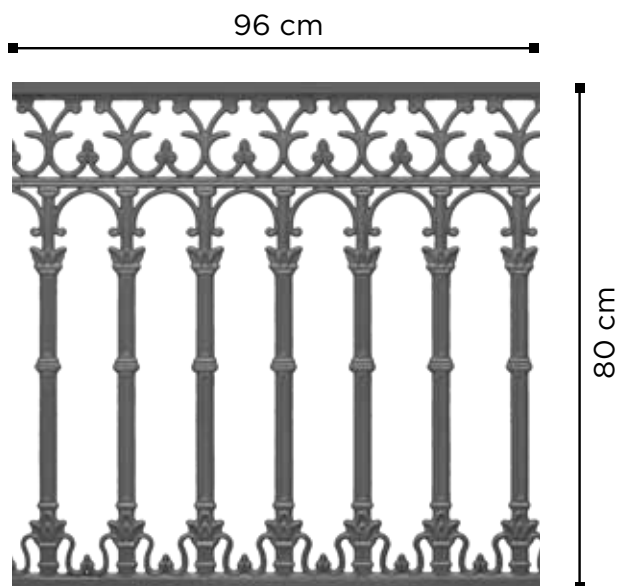

80-05

CHIASTI

ΥΨΟΣ ΚΑΓΚΕΛΟΥ / **RAILING HEIGHT**
ΑΠΟ/**FROM 45** ΕΩΣ/**UPTO 80** CM

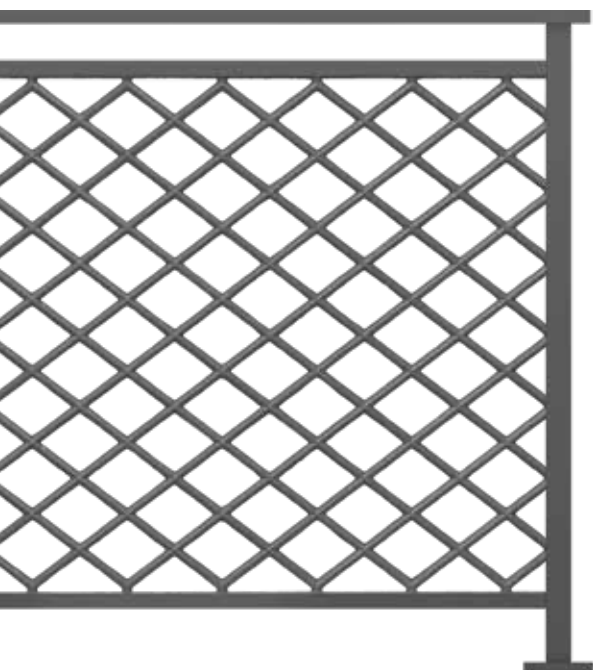

ΨΑΘΑ / PSATHA

ΜΗΚΟΣ / **LENGTH** 480 CM

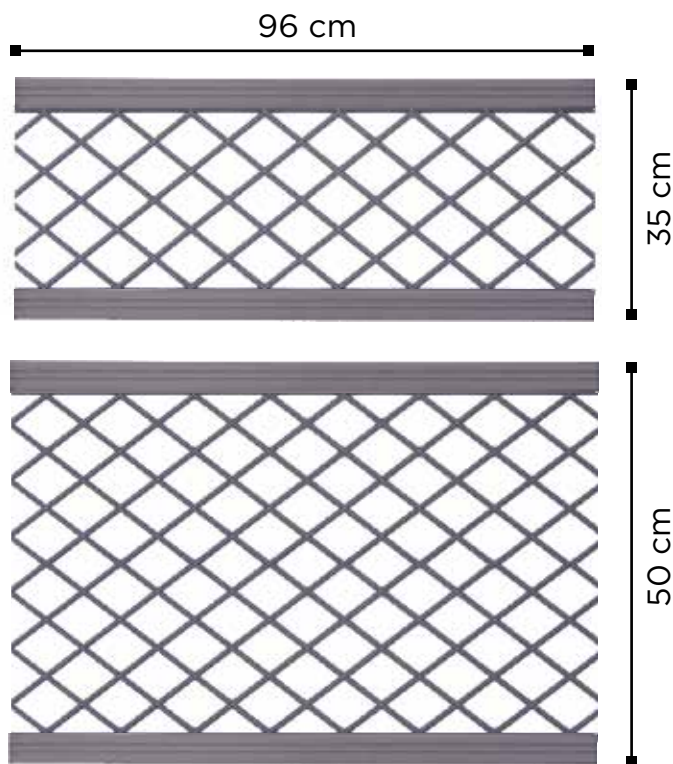

35-11

50-14



ALFLEX



Τα κλασικά κάγκελα αλουμινίου της σειράς ALFLEX διακρίνονται για την ευελιξία τους, όπως υποδηλώνει και το όνομά τους, flexible aluminium. Προσφέροντας μοναδική προσαρμοστικότητα σε διάφορους χώρους και αρχιτεκτονικά στυλ, τα κάγκελα ALFLEX αποτελούν μια ιδανική επιλογή για κάθε έργο, είτε οικιακό είτε επαγγελματικό.

Τα ALFLEX είναι στοιχεία αλουμινίου με ειδικά σχεδιασμένες κινητές κεφαλές, τοποθετημένες στο επάνω και κάτω μέρος, με τη κάθε κεφαλή να στηρίζεται αυτόνομα στο υπόλοιπο σύστημα κάγκελου. Χάρη σε αυτόν τον καινοτόμο σχεδιασμό, όλα τα στοιχεία ALFLEX με το ίδιο ύψος μπορούν να συνδυαστούν μεταξύ τους, προσφέροντας εξαιρετική ευελιξία, χωρίς να θυσιάζεται η σταθερότητα και η αντοχή της κατασκευής.

Η ευέλικτη φύση τους επιτρέπει εύκολη τοποθέτηση και προσαρμογή σε διαφορετικές διατάξεις, ενώ η κατασκευή από αλουμίνιο εξασφαλίζει αντοχή και μακροχρόνια χρήση με ελάχιστη συντήρηση. Τα κάγκελα ALFLEX προσφέρουν όχι μόνο ασφάλεια, αλλά και υψηλή αισθητική, καθιστώντας τα μια εξαιρετική επιλογή για κάθε εφαρμογή.

Το AL-FLEX τοποθετείται σε ευθεία και σε σκάλα.

The classic aluminum railings of the ALFLEX series are distinguished by their flexibility, as suggested by their name, flexible aluminum. Offering unique adaptability to various spaces and architectural styles, ALFLEX aluminium railings are an ideal choice for any project, whether residential or commercial.

The ALFLEX system consists of aluminum elements with specially designed movable heads positioned at the top and bottom, with each head independently supported by the overall railing system. Thanks to this innovative design, all ALFLEX elements of the same height can be combined, providing exceptional flexibility without compromising the stability and robustness of the structure.

Their flexible nature allows for easy installation and adjustment to different layouts, while the aluminum structure ensures durability and long-term use with minimal maintenance. ALFLEX railings not only provide safety but also deliver high aesthetic value, making them an excellent choice for any application.

AL-FLEX can be placed on staircases as well as on level surfaces

ALFLEX

Διάταξη με κλίση για σκάλα
Diagonal configuration for stairs



Οριζόντια διάταξη για κάγκελο
Horizontal configuration for railings



SAITA	ARROW	MINOAN A	MINOAN B	SUN	DILOS
CODE	CODE	CODE	CODE	CODE	CODE
85-42	85-43	85-46	85-47	85-48	85-49
6 pc/m	6 pc/m	7 pc/m	7 pc/m	7 pc/m	7 pc/m

Διάταξη με κλίση για σκάλα
Diagonal configuration for stairs

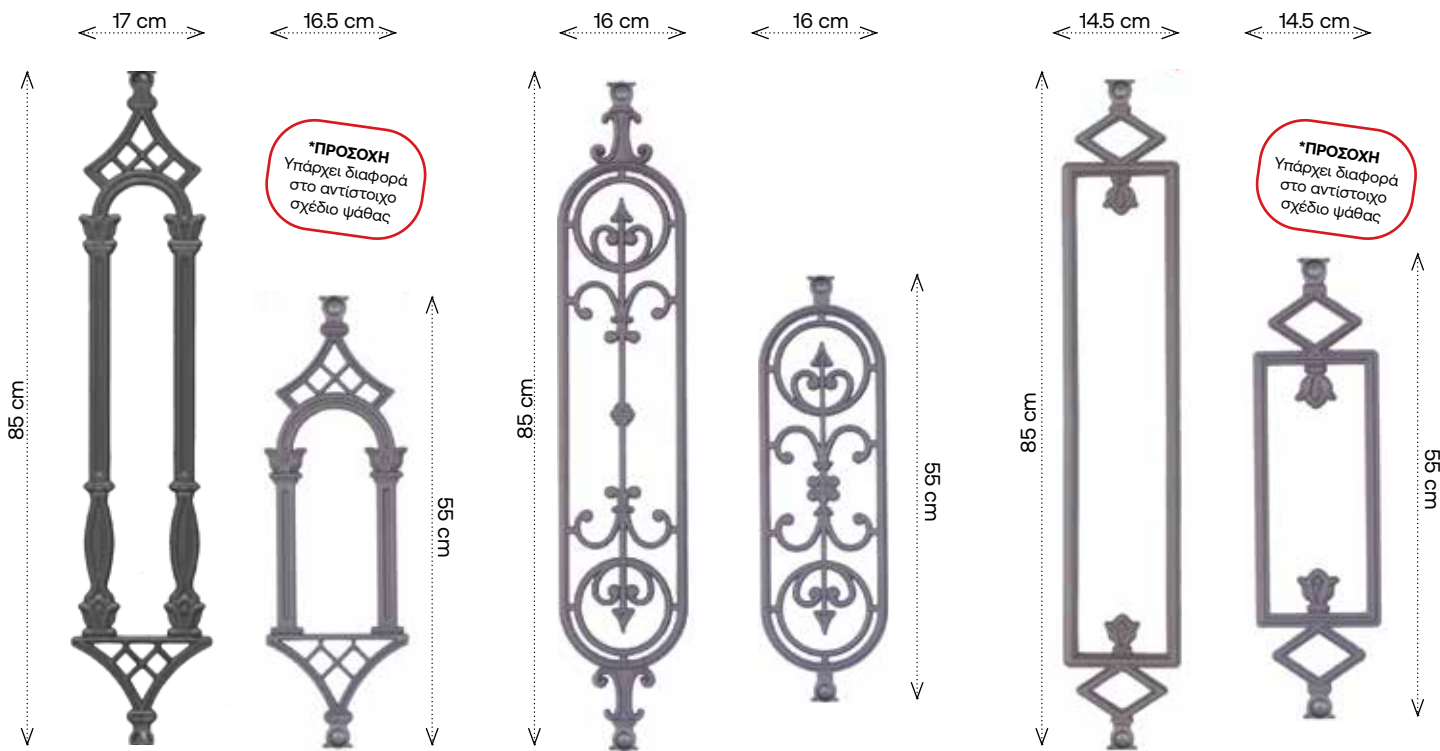

KAMARA*	
CODE	
85-34	55-38
4 pc/m	

KORONA	
CODE	
85-39	55-30
4 pc/m	

KOLONATO*	
CODE	
85-35	55-40
4 pc/m	

ALFLEX

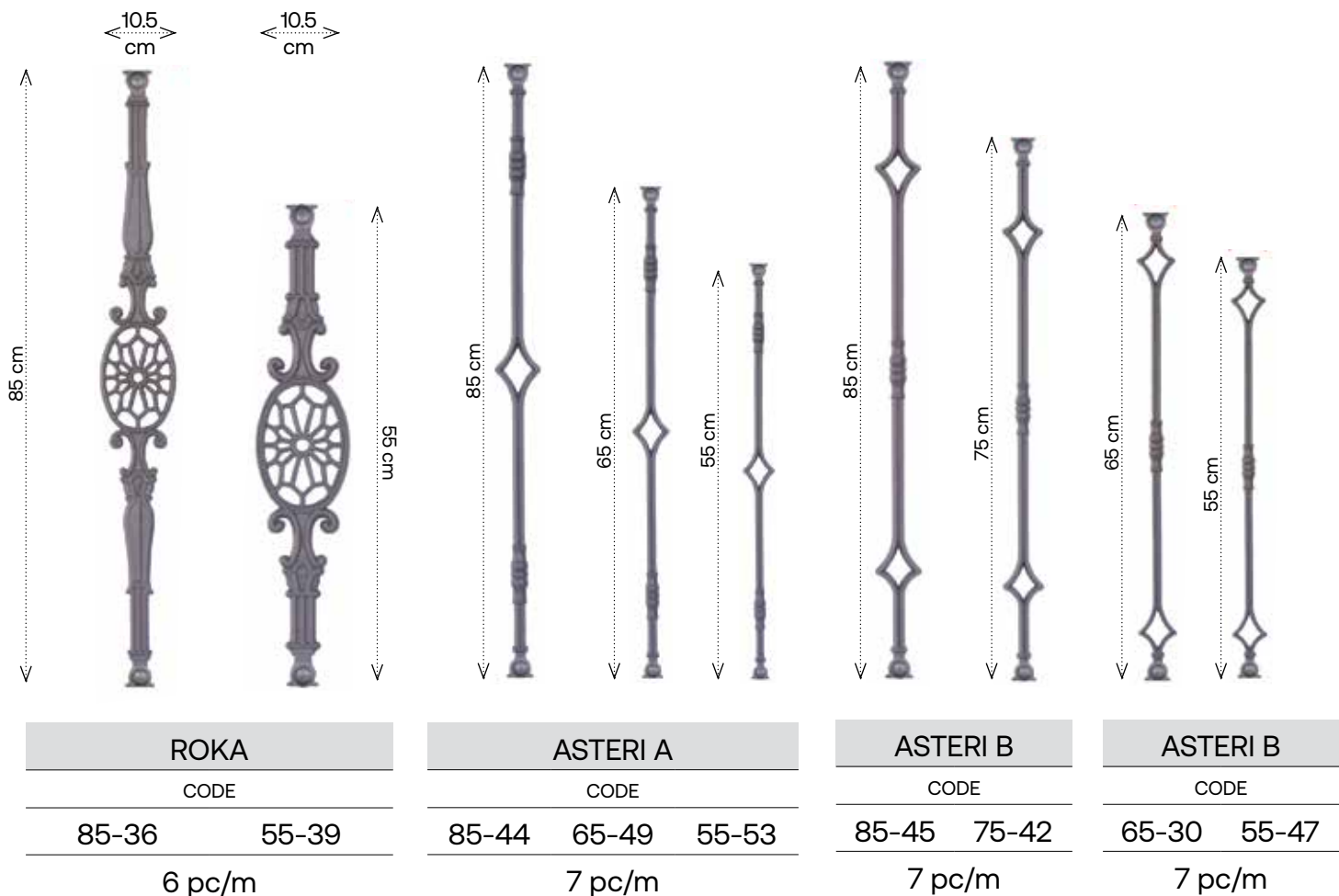



***ΠΡΟΣΟΧΗ**
Υπάρχει διαφορά
στο αντίστοιχο
σχέδιο ψάθας

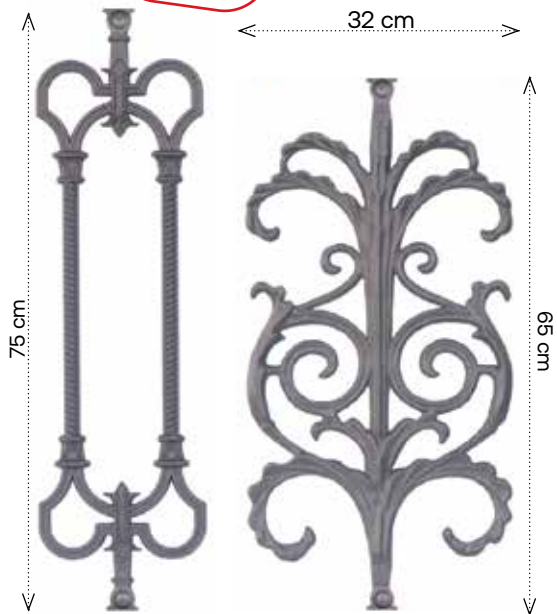

VIENNA*
CODE
75-31
4 pc/m

AKANTHOS
CODE
65-41
3 pc/m

EROTAS
CODE
65-42

ALFLEX

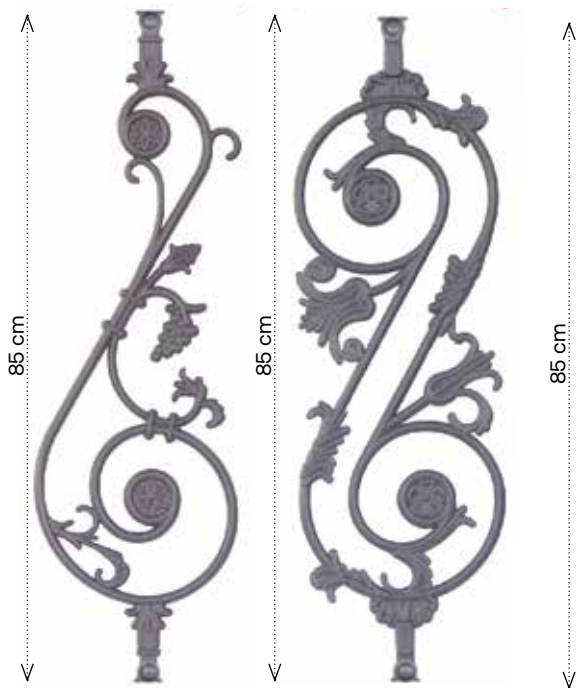

AGIOKLIMA	LOUVRE
CODE	CODE
85-30	85-31
3 pc/m	3 pc/m



ΜΑΚΡΙΑΝΝΙ*	
CODE	
85-41	55-31
4 pc/m	

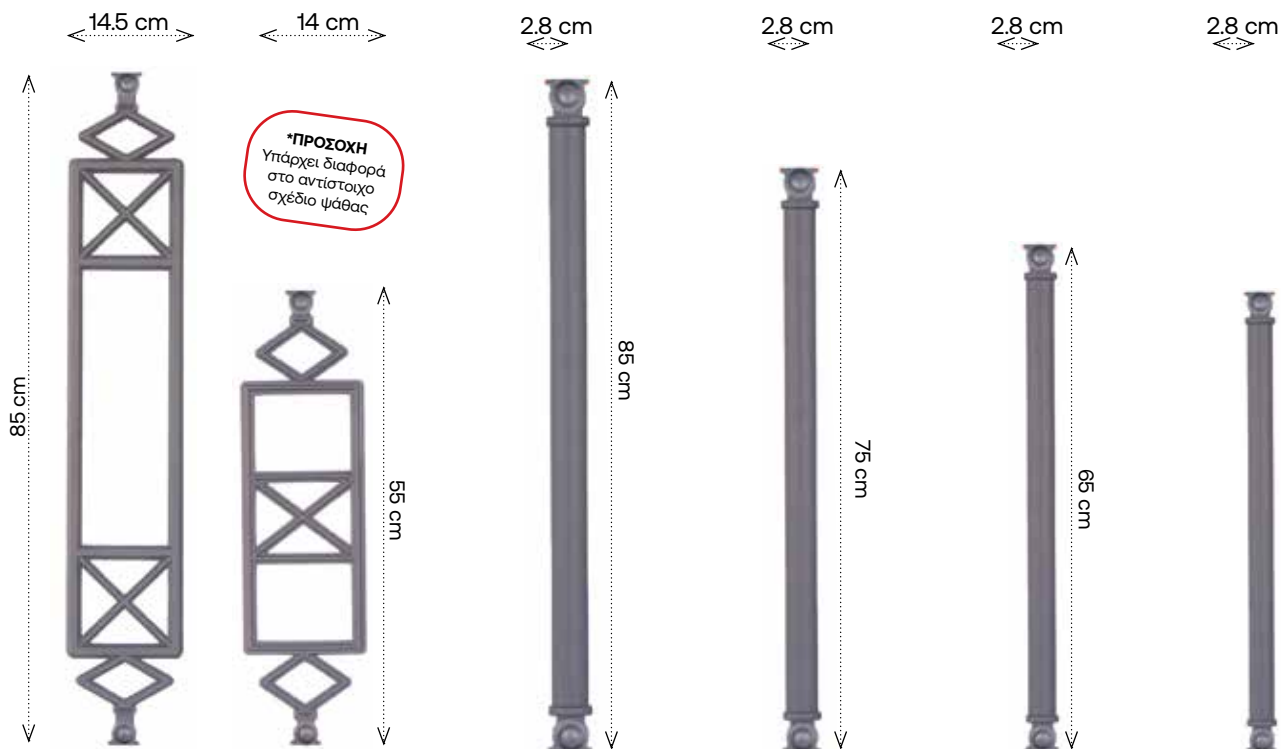

ΕΘΝΙΚΙΣ*	
CODE	
85-40	55-42
4 pc/m	

LINEAR			
CODE			
85-50	75-41	65-45	55-50
9 pc/m	9 pc/m	9 pc/m	9 pc/m

ALFLEX



ΤΟΠΟΘΕΤΗΣΗ/ INSTALLATION

Τοποθέτηση στο
μπетόν με Πείρο
Αγκύρωσης 4188

Ground Fixing with
Anchor Pin 4188

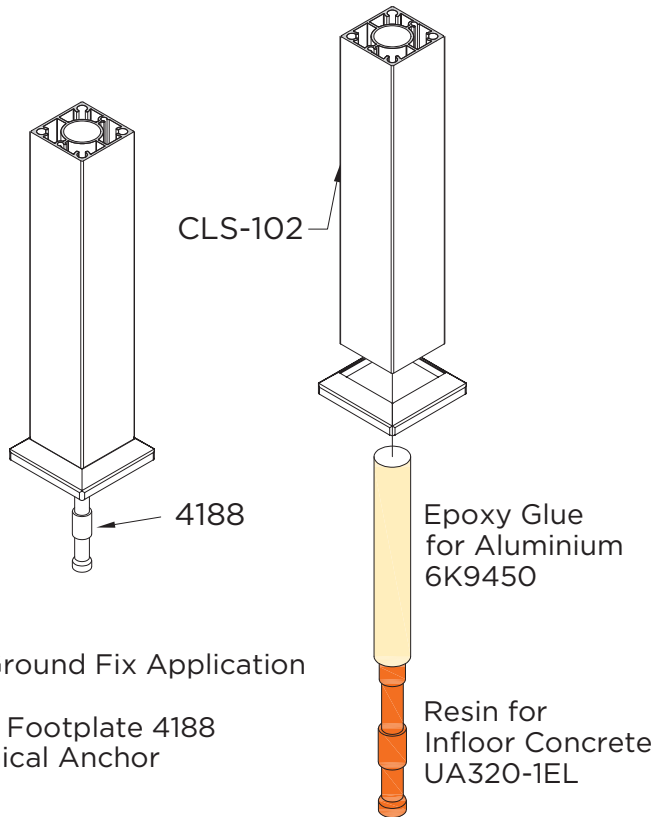

2nd Ground Fix Application

Using Footplate 4188
Chemical Anchor

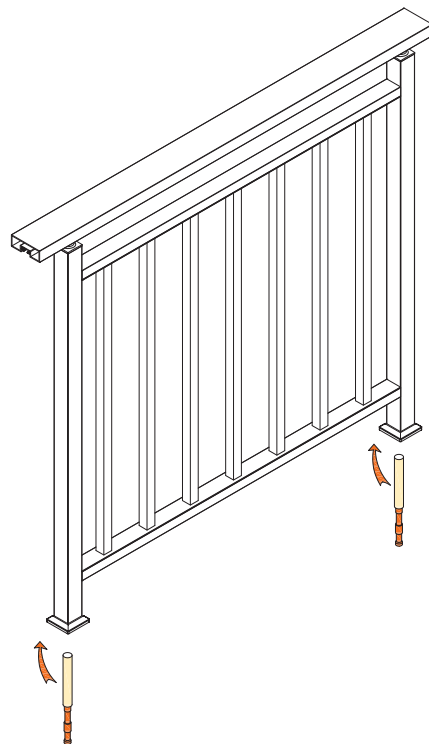

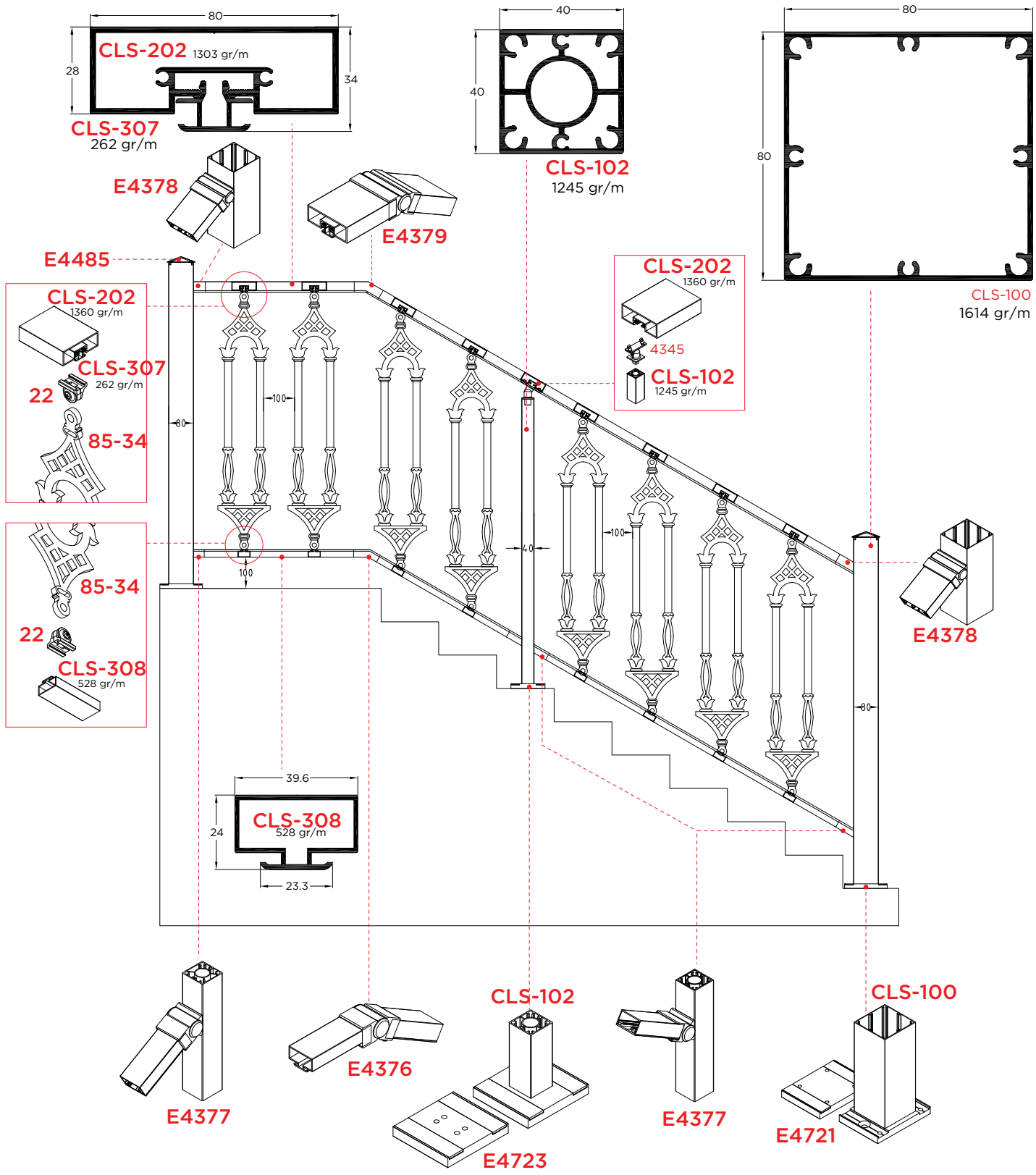

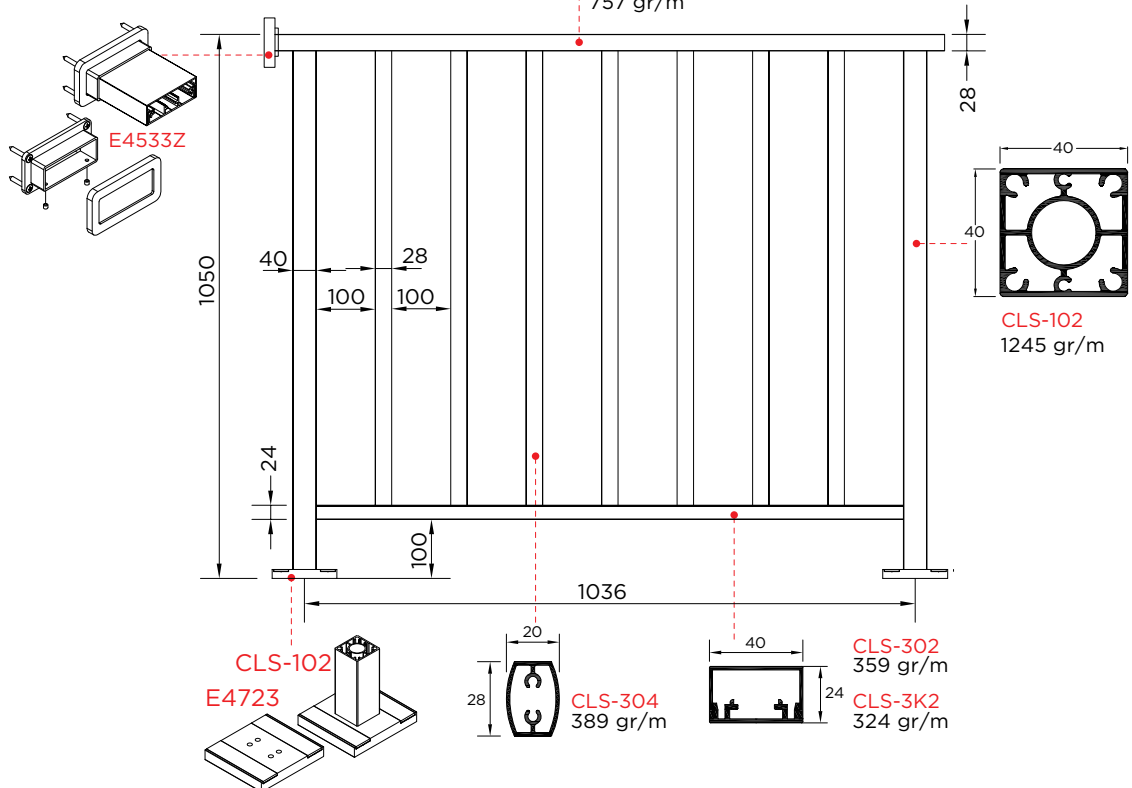
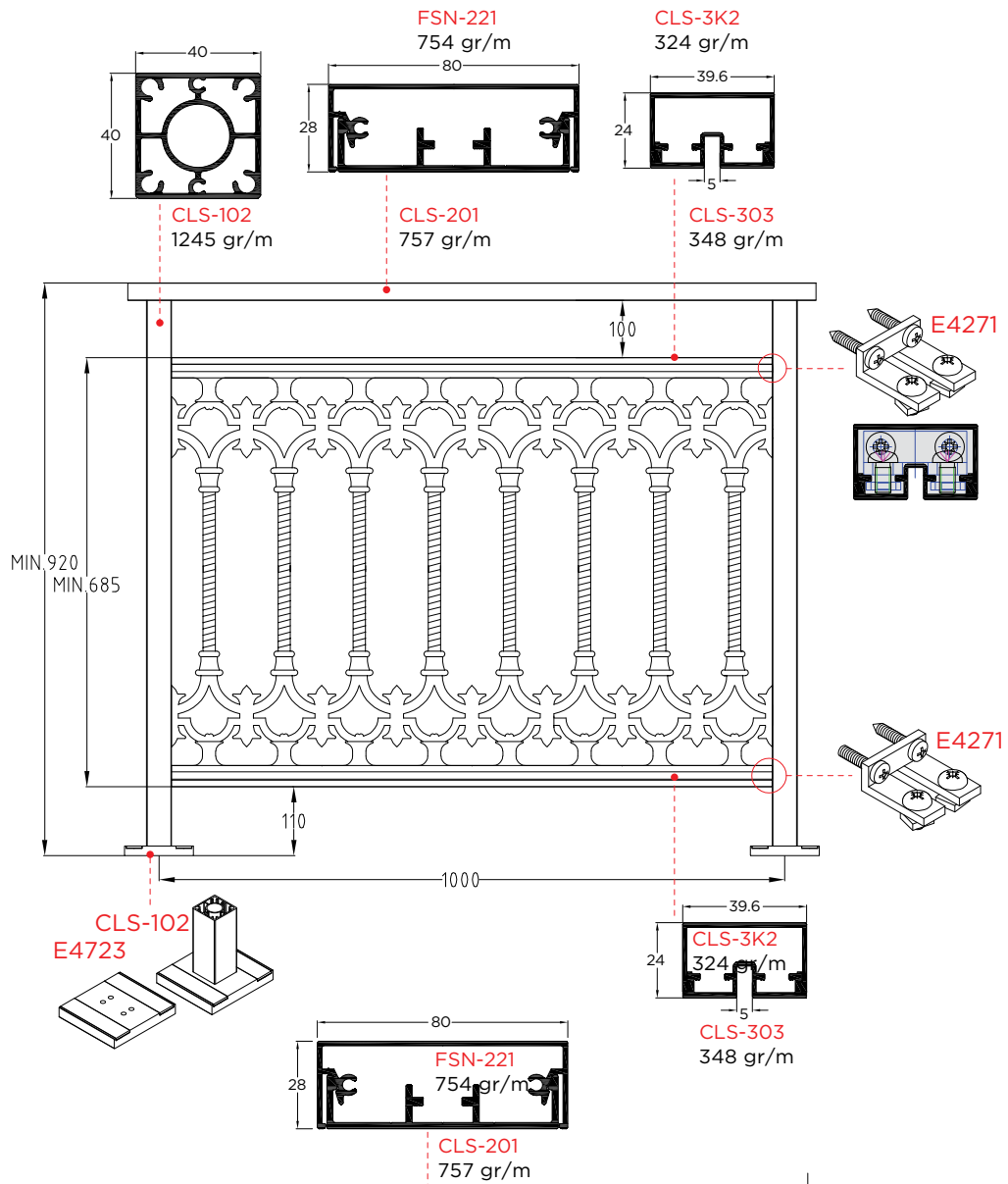

Στατικές δοκιμές

Δοκιμές: Σύμφωνα με το Γαλλικό πρότυπο NF PO1-013/1985

1. Οριζόντια φορτία από μέσα προς τα έξω.

ΦΑΣΗ ΔΟΚΙΜΗΣ	ΠΑΡΑΜΟΡΦΩΣΗ ΣΕ mm				ΑΠΑΙΤΗΣΕΙΣ
	ΘΕΣΗ 1	ΘΕΣΗ 1	ΘΕΣΗ 1	ΘΕΣΗ 1	
Μεταφόρτιση 3 λεπτών	3	13	15	a2	
Μεταφόρτιση 15 λεπτών	4	22	23	3	
Παραμένουσα μεταμόρφωση	0.3	0.5	0.6	0.1	<8 mm

2. Οριζόντια φορτία από έξω προς τα μέσα. Παραμόρφωση μετά φόρτιση 1 λεπ. = 4.6 mm

Παραμένουσα παραμόρφωση = 0

Επιτρεπόμενη (NF PO 1-13) = < 15 mm

3. Κατακόρυφη

Παραμένουσα παραμόρφωση = 0

Επιτρεπόμενη (NF PO 1-13) = < 3 mm

Δυναμικές δοκιμές

Δεν προέκυψε πτώση τεμαχίων προς τα έξω

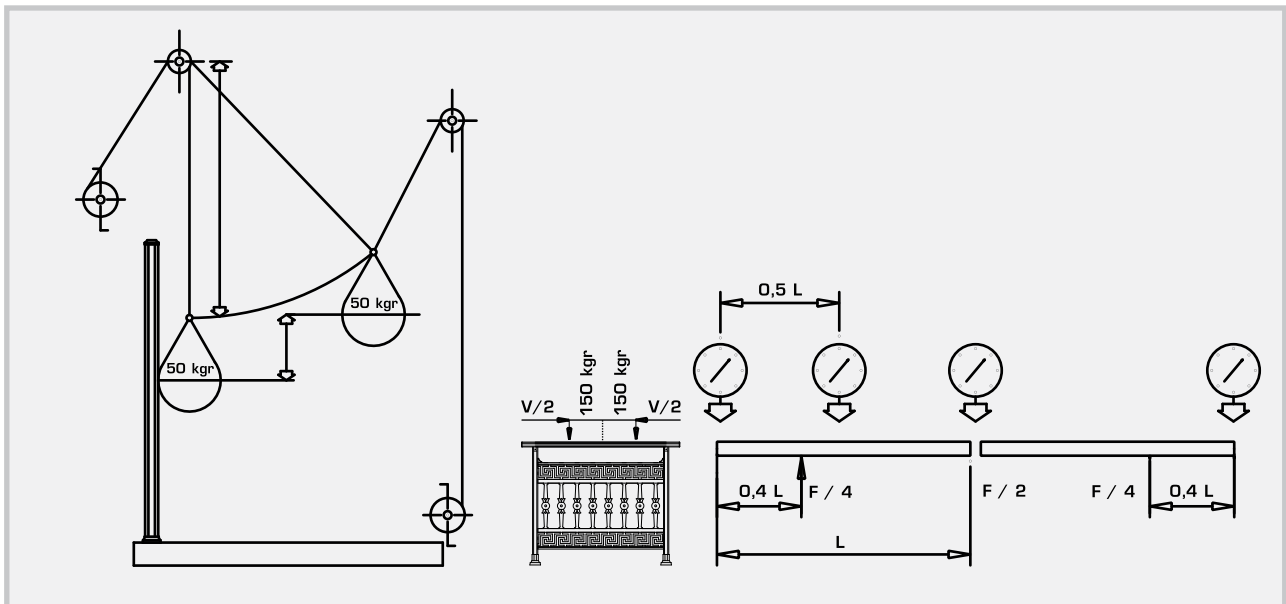

Συμπεράσματα

Από τα ανωτέρω αποτελέσματα προκύπτει ότι τα κάγκελα που εξετάστηκαν ικανοποιούν τις απαιτήσεις του Γαλλικού προτύπου NF PO 1-0 13 τόσο για ιδιωτικούς όσο και δημόσιους χώρους.

Synthesis



- Χαρακτηρίζεται για την minimal σχεδίαση και μοντέρνα αισθητική του.
- Η μοναδικότητα του έγκειται στο γεγονός ότι το 80% της κατασκευής του γίνεται στο εργοστάσιο και το 20% στο έργο.
- Ταχύτητα και ευκολία στην κατασκευή και την τοποθέτηση.
- Κατασκευή ανεξάρτητων πλαισίων (πάνελ).
- Διαιρούμενη κουπαστή που συνδέει τα ανεξάρτητα πλαίσια.
- Πλάτος όψης κολώνας 12 mm.
- Μέγιστο πλάτος από κολώνα σε κολώνα 1300 mm.
- Μεγάλη ποικιλία συνδυασμών προφίλ.
- Τα εξαρτήματα είναι από προφίλ αλουμινίου.
- Προφίλ ορθογώνιας και οβάλ διατομής.
- Διατίθεται σε όλες τις αποχρώσεις ηλεκτροστατικής και ανοδίωσης.

- **Contemporary minimal design with a sleek finish look.**
- **Fast and easy assembly as well as installation.**
- **80% of fabrication is done in-house while only 20% needs to be finished on site.**
- **Pre-fabricated independent panels.**
- **Split section top handrail connects total span of railings.**
- **Column width 12 mm.**
- **Maximum span between columns 1300 mm.**
- **Wide range of profile combinations.**
- **Choice of rectangular or oval cross sections.**
- **All components are made of durable aluminium.**
- **Available in wide range of powder coating finishes.**
- **Suitable for balconies, ideal for residences as well as hotel facilities.**

Synthesis



Linear



Linear



The image shows a modern building facade with a series of vertical balustrades. To the left, there is a vertical garden with green plants. The building has a clean, minimalist design with a light-colored wall and dark window frames. The balustrades are made of dark, vertical slats.

Linear

Vertical Balustrades

- Χαρακτηρίζεται για την minimal σχεδίαση και μοντέρνα αισθητική του.
- Δυνατότητα επιδαπέδιας ή πλάγιας στήριξης.
- Η μοναδικότητα του έγκειται στο γεγονός ότι το 80% της κατασκευής του γίνεται στο εργοστάσιο και το 20% στο έργο.
- Ταχύτητα και ευκολία στην κατασκευή και την τοποθέτηση.
- Διαιρούμενη κουπαστή που συνδέει τα ανεξάρτητα πλαίσια.
- Δυνατότητα επιλογής διαφορετικών κάθετων στοιχείων
- Τα εξαρτήματα είναι από προφίλ αλουμινίου.
- Διατίθεται σε όλες τις αποχρώσεις ηλεκτροστατικής και ανοδίωσης.
- Χρησιμοποιείται ένα ενιαίο προφίλ σαν βάση στήριξης

Linear

- **Contemporary minimal design with a sleek finish look.**
- **Top or side mount fixation types**
- **Fast and easy assembly as well as installation.**
- **80% of fabrication is done in-house while only 20% needs to be finished on site.**
- **Split section top handrail connects total span of railings.**
- **Choice of different vertical balustrades**
- **All components are made of durable aluminium.**
- **Available in wide range of powder coating finishes.**
- **Use of one single profile as base ground fixation profile in both top and side mount.**



Linear

Vertical Fences

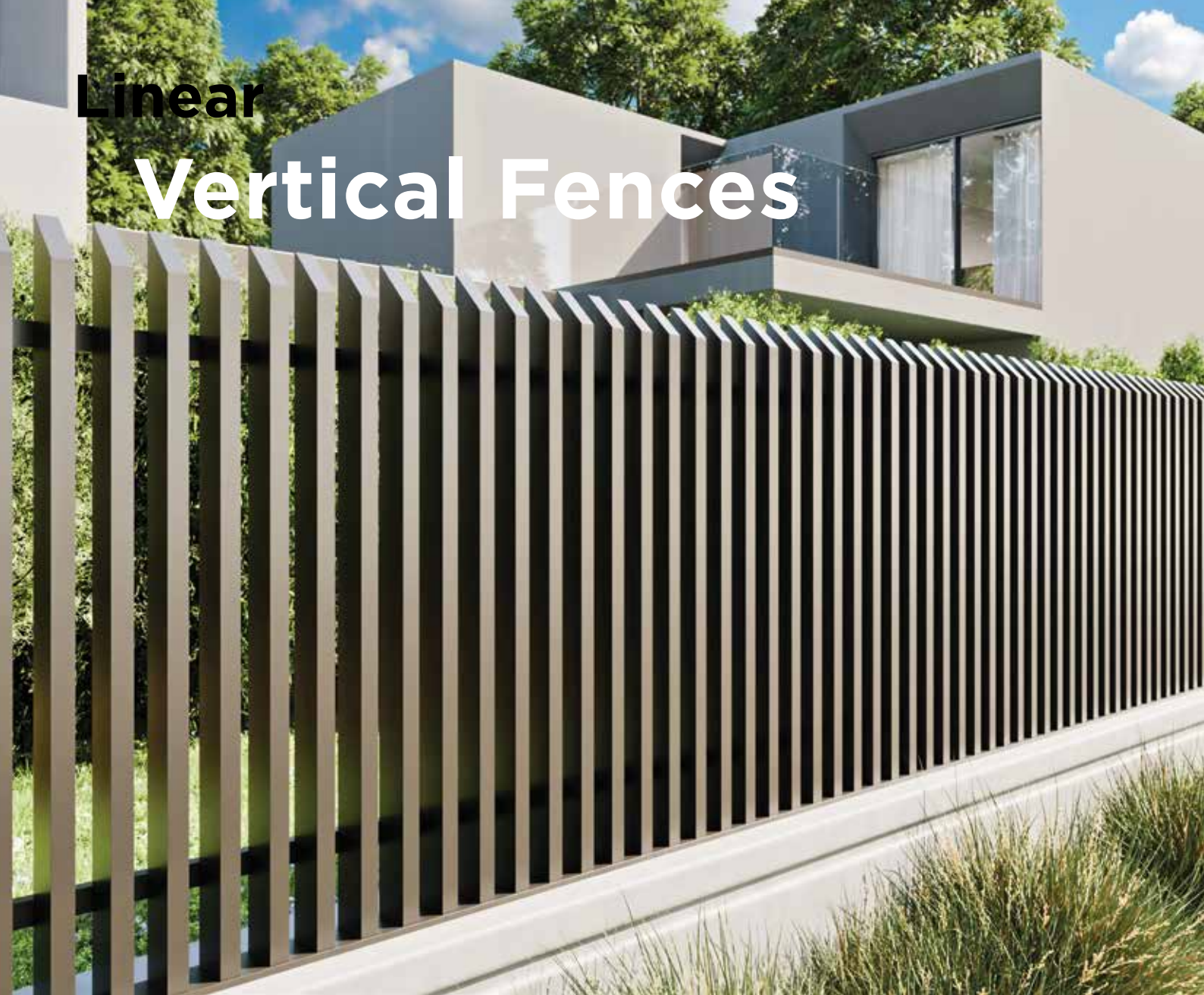

Μέγιστο ύψος κατασκευής 120 cm
Maximum fence height 120 cm



Linear



A modern, multi-story building with a balcony and a gate. The building has a grey, textured facade and a balcony with a glass railing. The gate is made of dark, horizontal slats. The background shows a blue sky with white clouds and green trees.

GATES & FENCES

GATES & FENCES

Βελτιώστε την ασφάλεια και το στυλ του σπιτιού σας με την εκτεταμένη μας γκάμα αυλόπορτων και αυλόγυρων.

Είτε επιλέξετε μια κλασική αυλόπορτα είτε μια πιο μοντέρνα, θα αντέξουν στον χρόνο, καθώς είναι ανθεκτικές και στις πιο απαιτητικές καιρικές συνθήκες (πχ. παραθαλάσσιες περιοχές) λόγω της υψηλής ποιότητας της ηλεκτροστατικής βαφής και των συνεργάσιμων εξαρτημάτων, τα οποία παρουσιάζουν υψηλή ανθεκτικότητα και αντιδιαβρωτική προστασία.

Οι αυλόπορτες διατίθενται σε ανοιγόμενες και συρόμενες, δίφυλλες ή μονόφυλλες, προσφέρουν κατασκευές μεγάλων διαστάσεων, και με την δυνατότητα επιλογής εξατομικευμένων λύσεων καλύπτουν το σύνολο των τεχνικών και αισθητικών αναγκών.

Enhance your home's security and style with our extensive range of gates and fences.

Whether you select a classic gate or a contemporary one, they will stand up to the test in time, as they are weather resistant even in coastal areas due to the high-quality powder coating and hardware.

Gates are available in many configurations, hinged pedestrian gate, sliding driveway gate or side gate.



ΤΟΠΟΘΕΤΗΣΗ / INSTALLATION

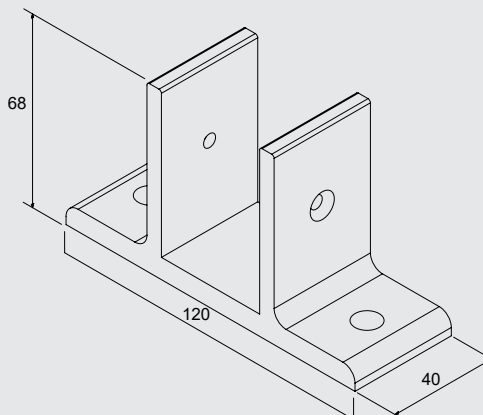
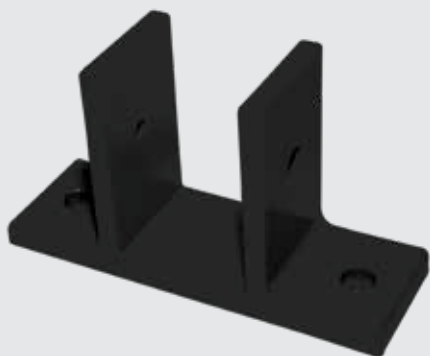

4120

Πέλμα στήριξης κολώνας 963 & 965,
F50-102, 106, 109, CLS-102

**Support foot for column 963 & 965,
F50-102, 106, 109, CLS-102**

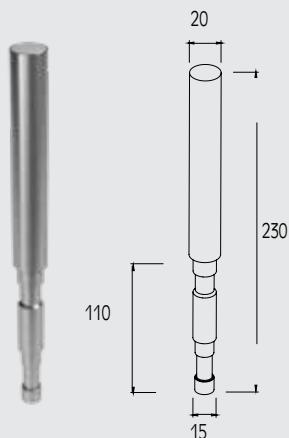

4188

ΕΝΔΟΔΑΠΕΔΙΟ ΣΤΗΡΙΓΜΑ ΚΟΛΩΝΑΣ CLS-102
INFLOOR SUPPORT FOR CLS-102 COLUMN

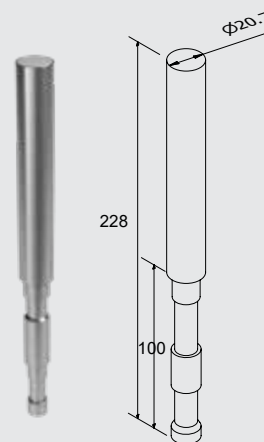

4167

ΕΝΔΟΔΑΠΕΔΙΟ ΣΤΗΡΙΓΜΑ ΚΟΛΩΝΑΣ F50-115
INFLOOR SUPPORT FOR F50-115 COLUMN

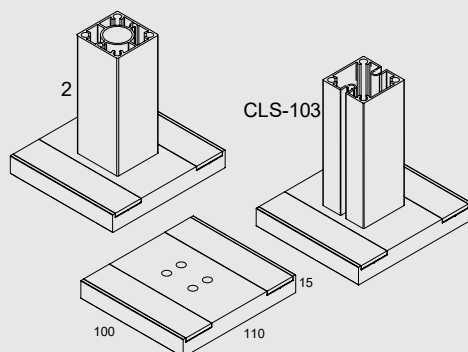

4723

Πέλασμα στήριξης κολώνας CLS-102, 103,104
Support foot for column CLS-102, 103,104

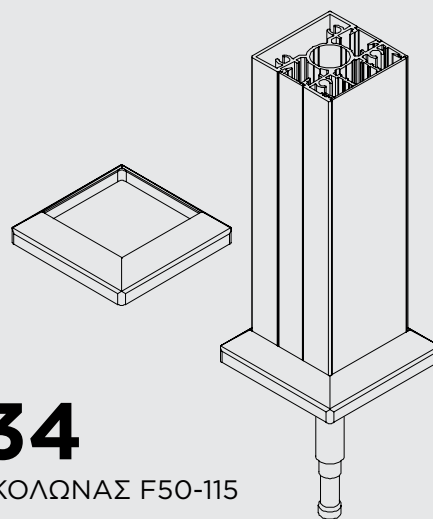
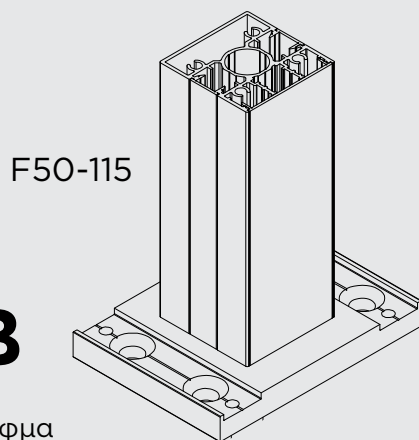

4745-B

Πέλασμα στήριξης με
 ενδοδαπέδειο στήριγμα
 κολώνας F50-115
**Support foot with infloor
 support for column F50-115**

4534

ΚΑΠΑΚΙ ΚΟΛΩΝΑΣ F50-115
TOP COVER FOR POST F50-115



THE LINEAR GATE

Ένα καθαρό γραμμικό σχέδιο που παίρνει τη μορφή του από τις σύγχρονες αρχιτεκτονικές τάσεις. Λεπτά προφίλ αλουμινίου, οριζόντια ευθυγραμμισμένα, δημιουργούν ένα κομψό περιβάλλον διαβίωσης, προσφέροντας προστασία και ελευθερία σε πλήρη ισορροπία.

With the moto “less is more” in mind, the Linear Series has become the icon of a contemporary home. Slender aluminium profiles, horizontally aligned, create a stylish living environment, offering protection and freedom in equal measures.

LINEAR WELD SWING-PIVOT OPEN GATE

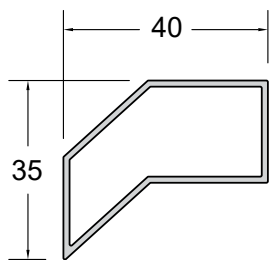

PF144-082

410 gr/m, 6m

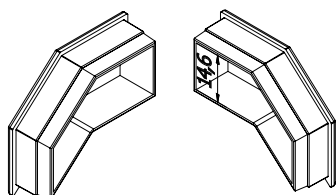

E4946

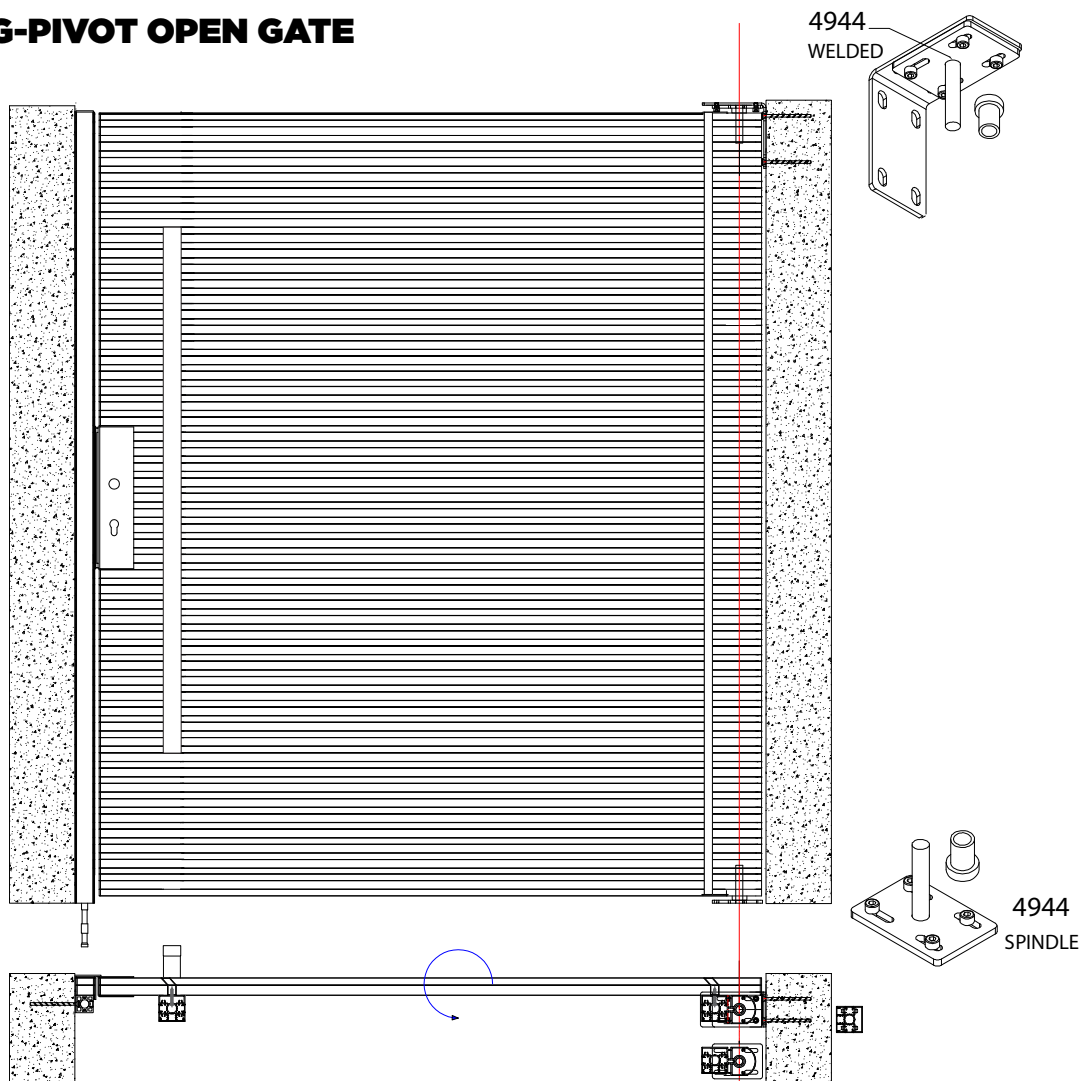

LINEAR FENCE





THE XPAND SOLUTION

Όταν δημιουργείτε με μοτίβα Xpand, το μόνο όριο είναι η φαντασία σας! Το Xpand είναι ένα πολυμορφικό, ελαφρύ, οικονομικό πλέγμα αρχιτεκτονικού σχεδιασμού, που προσαρμόζεται τέλεια στις αυλόπορτες και τους αυλόγυρους.

When dealing with Xpand patterns, the only limit is your imagination! Xpand is a polymorphic, light, cost-effective architectural design mesh, that adapts perfectly well within gates and fences.

THE XPAND SOLUTION

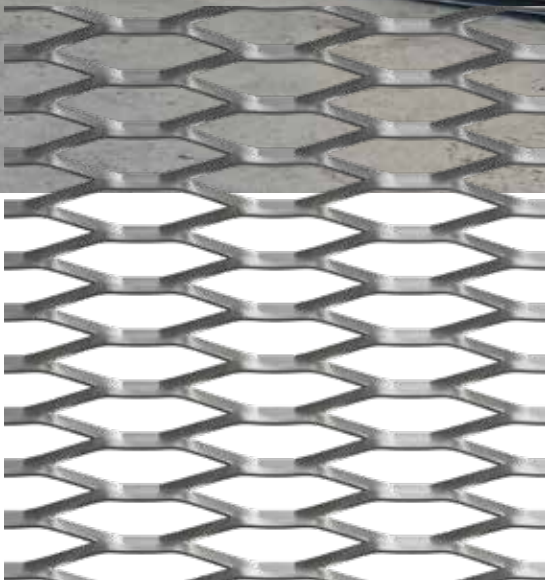

XP206

OPEN AREA: 67.5 %

WEIGHT PER m²: 2.8 Kg/m²

LWO: 77.8 mm / SWO: 14 mm

STRAND WIDTH: 6 mm

OVERALL THICKNESS: 11 mm

DIMENSIONS (W x H):

1000 x No limit / 1250 x No limit / 1500 x No limit

Τα σχέδια Χrand διατίθενται σε διάφορες μορφές, μοτίβα και χρώματα που διαφοροποιούνται μεταξύ τους στις διαστάσεις, στη διαπερατότητα του φωτός και τον σχεδιασμό.

Χrand patterns are available in a variety of forms, motives and colors that differ according to the given dimensions, the light penetration and the design.

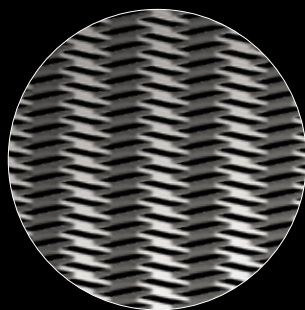

XP101

OPEN AREA: 49.3 %
WEIGHT PER m²: 3.4 Kg/m²
LWO: 43.5 mm / SWO: 10 mm
STRAND WIDTH: 4 mm
OVERALL THICKNESS: 7.5 mm
DIMENSIONS (W x H):
1000 x No limit / 1250 x No limit /
1500 x No limit

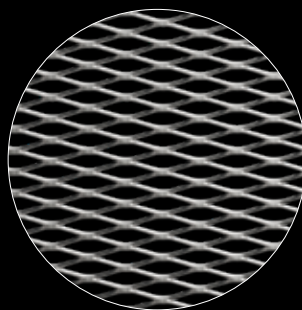

XP104

OPEN AREA: 67.7 %
WEIGHT PER m²: 2.37 Kg/m²
LWO: 49 mm / SWO: 11 mm
STRAND WIDTH: 4 mm
OVERALL THICKNESS: 8 mm
DIMENSIONS (W x H):
1000 x No limit / 1250 x No limit /
1500 x No limit

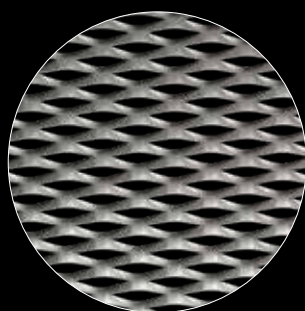

XP105

OPEN AREA: 49.3 %
WEIGHT PER m²: 3.58 Kg/m²
LWO: 47 mm / SWO: 10.5 mm
STRAND WIDTH: 8 mm
OVERALL THICKNESS: 11 mm
DIMENSIONS (W x H):
1000 x No limit / 1250 x No limit /
1500 x No limit

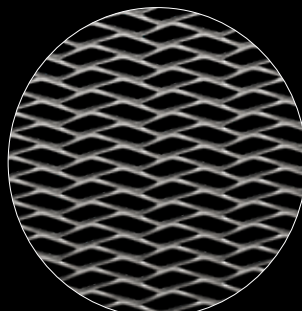

XP106

OPEN AREA: 62.4 %
WEIGHT PER m²: 2.29 Kg/m²
LWO: 52 mm / SWO: 15 mm
STRAND WIDTH: 4 mm
OVERALL THICKNESS: 7.8 mm
DIMENSIONS (W x H):
1000 x No limit / 1250 x No limit /
1500 x No limit

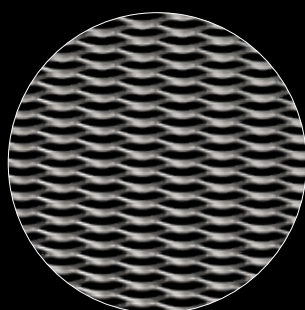

XP109

OPEN AREA: 59.4 %
WEIGHT PER m²: 3.10 Kg/m²
LWO: 42 mm / SWO: 7.5 mm
STRAND WIDTH: 4 mm
OVERALL THICKNESS: 7.5 mm
DIMENSIONS (W x H):
1000 x No limit / 1250 x No limit /
1500 x No limit

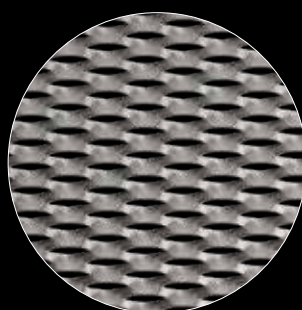

XP110

OPEN AREA: 37.0 %
WEIGHT PER m²: 4.42 Kg/m²
LWO: 41 mm / SWO: 6 mm
BHMA / STRAND WIDTH: 8 mm
OVERALL THICKNESS: 10.5 mm
DIMENSIONS (W x H):
1000 x No limit / 1250 x No limit /
1500 x No limit

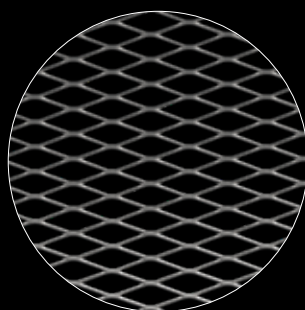

XP113

OPEN AREA: 68.7 %
WEIGHT PER m²: 2.16 Kg/m²
LWO: 52 mm / SWO: 15 mm
STRAND WIDTH: 4 mm
OVERALL THICKNESS: 9 mm
DIMENSIONS (W x H):
1000 x No limit / 1250 x No limit /
1500 x No limit

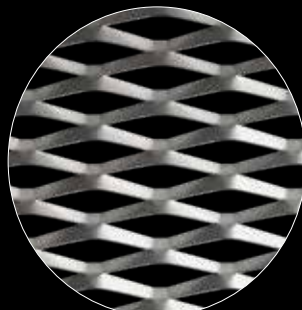

XP201

OPEN AREA: 50.1 %
WEIGHT PER m²: 3.6 Kg/m²
LWO: 93.5 mm / SWO: 19 mm
STRAND WIDTH: 14 mm
OVERALL THICKNESS: 18 mm
DIMENSIONS (W x H):
1000 x No limit / 1250 x No limit /
1500 x No limit

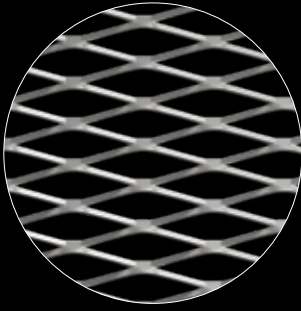
**XP203**

OPEN AREA: 65.8 %
 WEIGHT PER m²: 2.4 Kg/m²
 LWO: 96.2 mm / SWO: 25 mm
 STRAND WIDTH: 8 mm
 OVERALL THICKNESS: 13.5 mm
 DIMENSIONS (W x H):
 1000 x No limit / 1250 x No limit /
 1500 x No limit

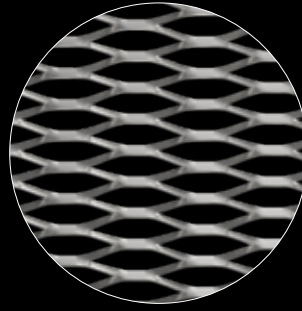
**XP204**

OPEN AREA: 64.3 %
 WEIGHT PER m²: 3 Kg/m²
 LWO: 82.8 mm / SWO: 18 mm
 STRAND WIDTH: 8 mm
 OVERALL THICKNESS: 14 mm
 DIMENSIONS (W x H):
 1000 x No limit / 1250 x No limit /
 1500 x No limit

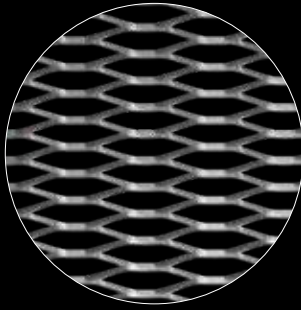
**XP206**

OPEN AREA: 67.5 %
 WEIGHT PER m²: 2.8 Kg/m²
 LWO: 77.8 mm / SWO: 14 mm
 STRAND WIDTH: 6 mm
 OVERALL THICKNESS: 11 mm
 DIMENSIONS (W x H):
 1000 x No limit / 1250 x No limit /
 1500 x No limit

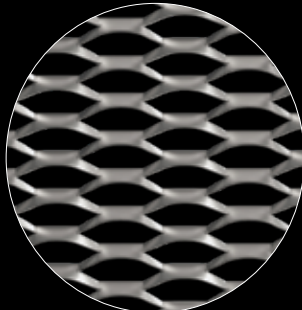
**XP301**

OPEN AREA: 64.8 %
 WEIGHT PER m²: 2.87 Kg/m²
 LWO: 71.8 mm / SWO: 18 mm
 STRAND WIDTH: 8 mm
 OVERALL THICKNESS: 13 mm
 DIMENSIONS (W x H):
 1000 x No limit / 1250 x No limit /
 1500 x No limit

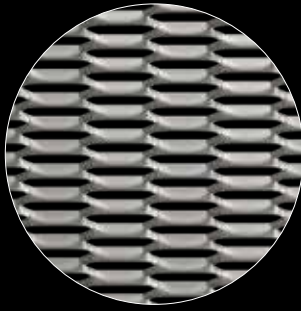
**XP302**

OPEN AREA: 56.6 %
 WEIGHT PER m²: 4.18 Kg/m²
 LWO: 56.7 mm / SWO: 6 mm
 STRAND WIDTH: 8 mm
 OVERALL THICKNESS: 11.5 mm
 DIMENSIONS (W x H):
 1000 x No limit / 1250 x No limit /
 1500 x No limit

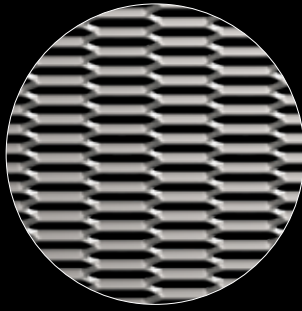
**XP303**

OPEN AREA: 42.6 %
 WEIGHT PER m²: 3 Kg/m²
 LWO: 54.4 mm / SWO: 5 mm
 STRAND WIDTH: 6 mm
 OVERALL THICKNESS: 9.5 mm
 DIMENSIONS (W x H):
 1000 x No limit / 1250 x No limit /
 1500 x No limit

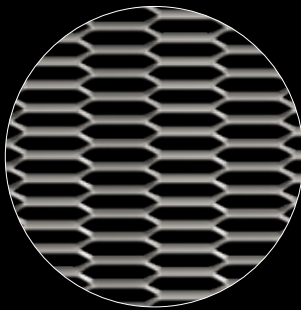
**XP304**

OPEN AREA: 45.5 %
 WEIGHT PER m²: 2.47 Kg/m²
 LWO: 58.6 mm / SWO: 10 mm
 STRAND WIDTH: 6 mm
 OVERALL THICKNESS: 10.5 mm
 DIMENSIONS (W x H):
 1000 x No limit / 1250 x No limit /
 1500 x No limit

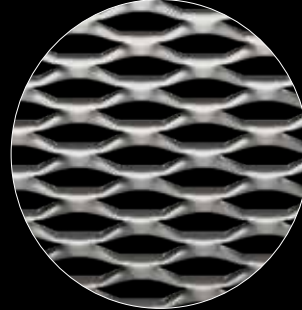
**XP333**

OPEN AREA: 58.6 %
 WEIGHT PER m²: 3.27 Kg/m²
 LWO: 84 mm / SWO: 19.5 mm
 STRAND WIDTH: 11 mm
 OVERALL THICKNESS: 15.5 mm
 DIMENSIONS (W x H):
 1000 x No limit / 1250 x No limit /
 1500 x No limit

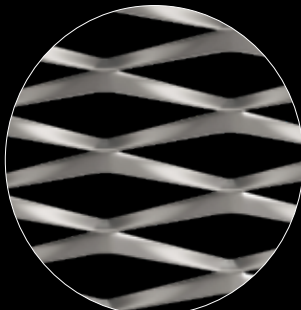
**XP401**

OPEN AREA: 62.7 %
 WEIGHT PER m²: 3.6 Kg/m²
 LWO: 180 mm / SWO: 38 mm
 STRAND WIDTH: 20 mm
 OVERALL THICKNESS: 28 mm
 DIMENSIONS (W x H):
 1000 x No limit / 1250 x No limit /
 1500 x No limit

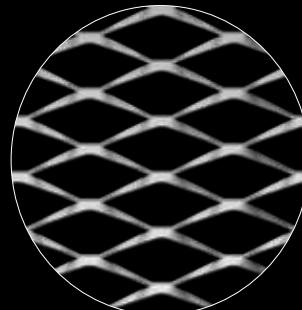
**XP503**

OPEN AREA: 55 %
 WEIGHT PER m²: 2.1 Kg/m²
 LWO: 102 mm / SWO: 35 mm
 STRAND WIDTH: 8 mm
 OVERALL THICKNESS: 14 mm
 DIMENSIONS (W x H):
 1000 x No limit / 1250 x No limit /
 1500 x No limit



MODULAR FENCE

Μοναδικές Περιφράξεις με Ραμποτέ 20cm: Ιδανική Λύση για Στιβαρότητα και Στυλ

Ανακαλύψτε τις ξεχωριστές περιφράξεις με ραμποτέ 20cm, σχεδιασμένες για να συνδυάζουν αισθητική και ανθεκτικότητα σε απόλυτη αρμονία.

Unique Fences with 20 cm Rabote: An ideal Solution for Robustness and Style.

Discover our distinctive 20cm rambote fences, designed to combine aesthetics and durability in perfect harmony.

MODULAR FENCE

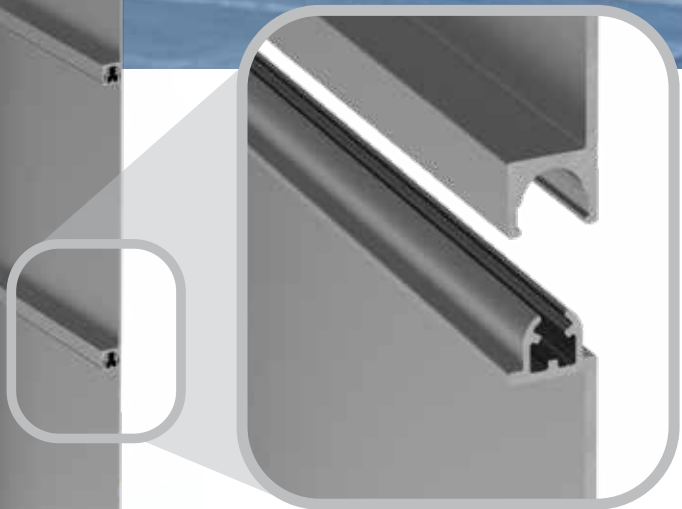

MODULAR FENCE

Επιλογή από ευρεία γκάμα σχεδίων / Selection of wide range of designs
Διατίθενται σε προφίλ μήκους 3 m / Available in 3 m profiles



P994-922D-27



P994-922D-29



P994-922D-31



P994-922D-33



P994-922D-35



P994-922D-37



P994-922D-28



P994-922D-30



P994-922D-32



P994-922D-34



P994-922D-36



P994-922D-38



MODULAR FENCE



- **Ευρεία Γκάμα Σχεδίων:** Διαθέσιμες σε ποικιλία 8 σχεδίων, προσδίδουν στον χώρο σας μοναδικότητα και χαρακτήρα.
- **Στιβαρή Κατασκευή:** Κατασκευασμένες με υψηλής ποιότητας υλικά, οι περιφράξεις μας αντέχουν στις απαιτήσεις του χρόνου και των καιρικών συνθηκών.
- **Ευκολία και ευελιξία στην τοποθέτηση:** Σχεδιασμένες για να τοποθετούνται εύκολα, και με δυνατότητα προσαρμογής στις ειδικές ανάγκες του κάθε χώρου.
- **Ποικιλία Χρωματικών Επιλογών:** Διατίθενται σε μεγάλη γκάμα χρωμάτων, ώστε να ταιριάζουν απόλυτα με το στυλ και την αισθητική του χώρου σας.
- **Εξατομικευμένο Στυλ:** Διαλέγετε το σχέδιο, τον αριθμό των διάτρητων ραμποτέ και τα σημεία πάνω στην πόρτα ή στο φράχτη όπου αυτά θέλετε να τοποθετηθούν. Έτσι η κάθε περίφραξη αναδεικνύει την αισθητική του χώρου σας, προσφέροντας μια κομψή και ασφαλή λύση για κατοικίες και επαγγελματικούς χώρους.
- **Wide Range of Designs:** Available in a variety of 8 designs, they provide your space with uniqueness and character.
- **Robust Construction:** Constructed with high quality materials, our fences can withstand the demands of time and of weather conditions.
- **Easy and flexible installation:** Designed to be easy to install they are adaptable to the specific needs of every space.
- **Variety of Color Options:** Available in a wide range of colors so as to perfectly match the style and aesthetics of your own space.
- **Personalized Style:** Choose the design, the number of perforated rambote and the specific places on the door or on the fence where you want them to be placed. Thus, each fence highlights the aesthetics of your space, offering an elegant and safe solution both for homes and business spaces.



THE WD SERIES

Τα νέα σχέδια στη σειρά Gates Fences, επενδύονται με τα cladding προφίλ wall and deco, δίνουν έναν αέρα εκλεπτυσμένης γραμμικής αισθητικής που εντυπωσιάζει. Με έμφαση στη μινιμαλιστική, αλλά ταυτόχρονα επιβλητική γραμμή, τα νέα αυτά σχέδια ξεχωρίζουν για την εξαιρετική εφαρμογή τους σε αυλόπορτες και αυλόγυρους, δημιουργώντας ένα αποτέλεσμα που αναβαθμίζει τον χώρο και προσδίδει μοναδικότητα.

The new designs in the Gates Fences series, clad with wall and deco cladding profiles, give an air of refined linear aesthetics that impresses. With an emphasis on minimalist, yet imposing lines, these new designs stand out for their excellent application on gates and fences, creating a result that upgrades the space and adds uniqueness.

THE WD SERIES



Εικόνες λεπτομέρειας για νέου Τύπου ροζέτες με ενσωματωμένο μηχανισμό χειρολαβής και ροζέτες αφαλού κλειδαριάς.

Detail photos for new type rosettes with integrated handle mechanism & rosettes for keyholes.

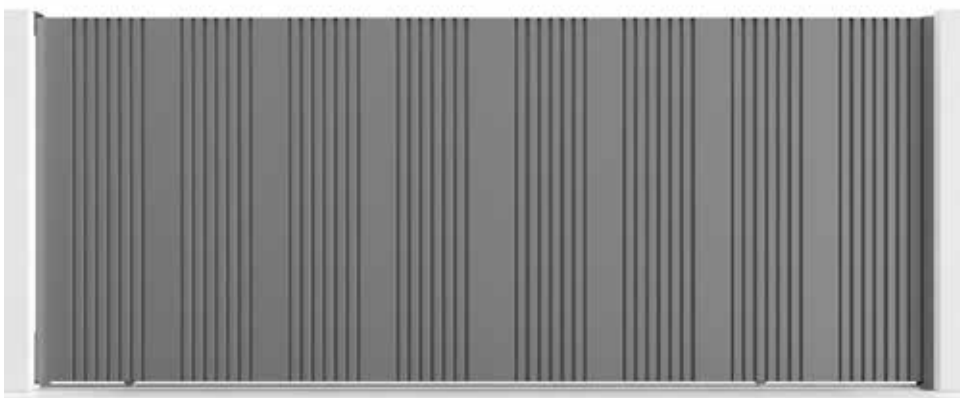

WD05-01



WD01-01

THE WD SERIES



WD05-01

THE WD SERIES

71



WD05-02

THE WD SERIES

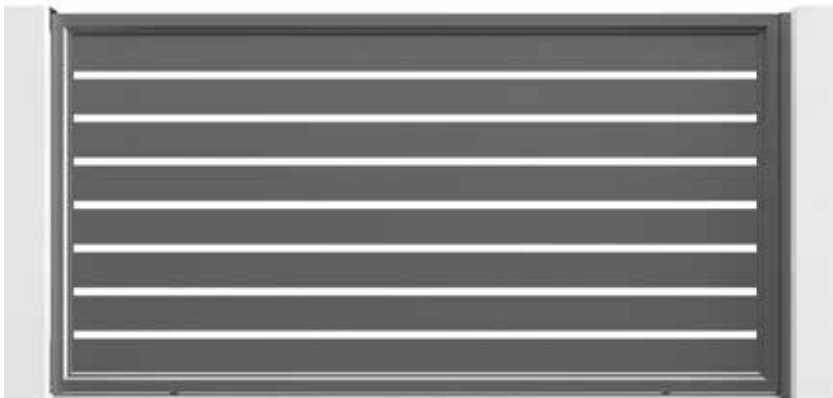

WD05-02

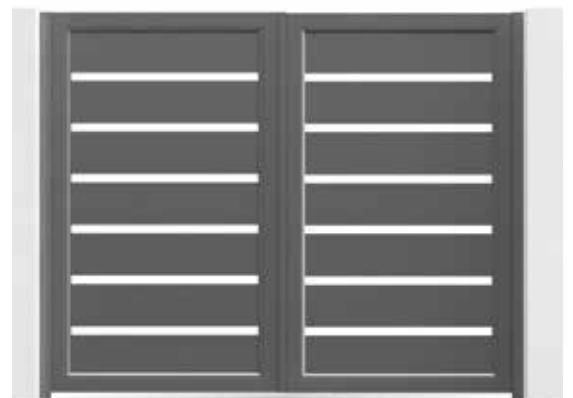

WD02-02

THE WD SERIES

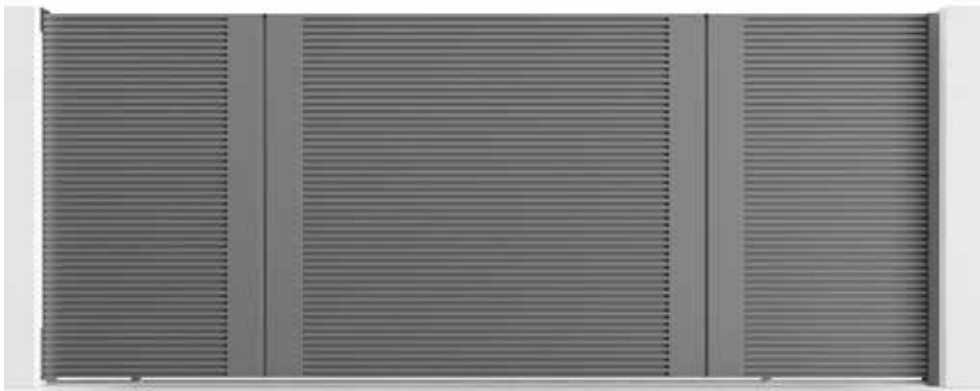

WD05-03



WD01-03

THE WD SERIES

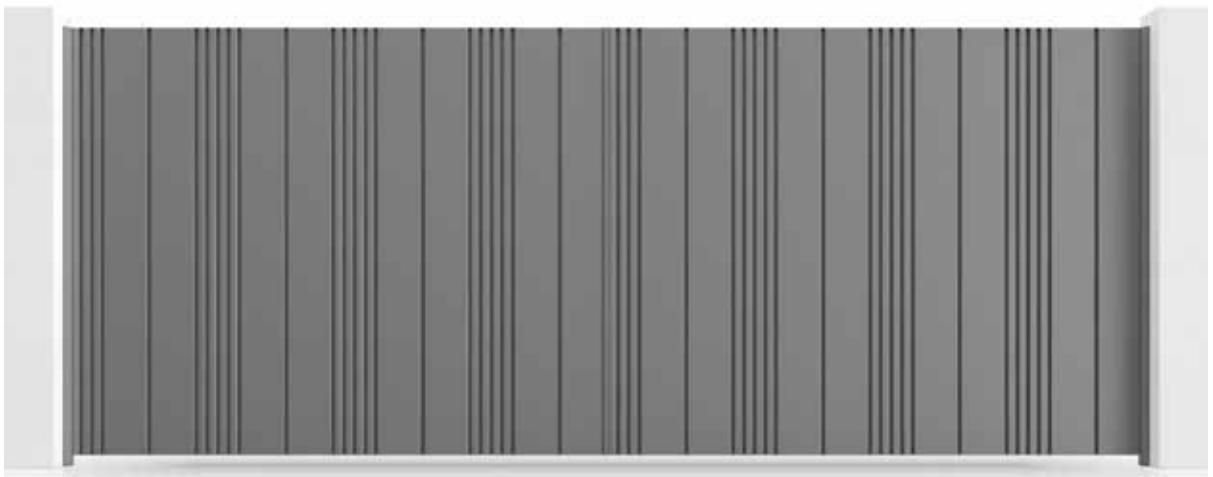

WD05-04

THE WD SERIES

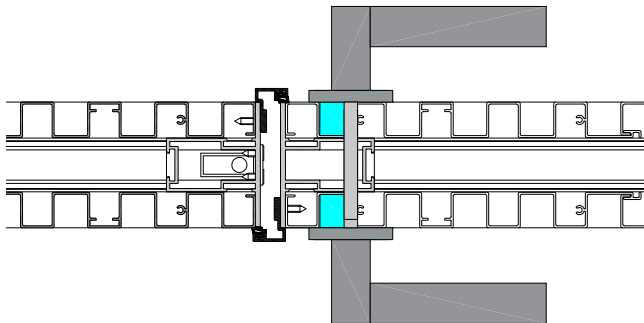

Τομή δίφυλλης ανοιγόμενης αυλόπορτας
με χειρολαβή και κρυφό σύρτη
**Section of double opening gate with
handle and latch**

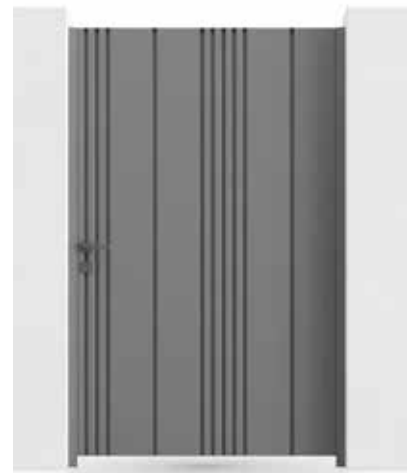

WD01-04

DESIGNER FENCES

Μοντέρνα σχέδια περιφράξεων και αμέτρητοι συνδιασμοί με κατεργασίες ελασμάτων αλουμινίου πάχους 3 mm. Δυνατότητα πλάτους μέχρι 4 m και ύψους 2 m.

L6510

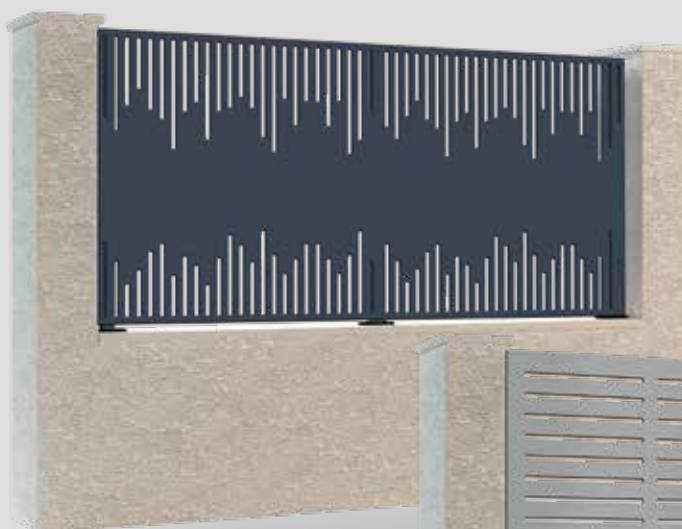

L6511



L6512



L6513



DESIGNER FENCES

Modern fence designs and countless combinations with 3 mm thick aluminum sheet treatments. Possibility of width up to 4 m and height 2 m.

L6514



L6515



L6516



L6517

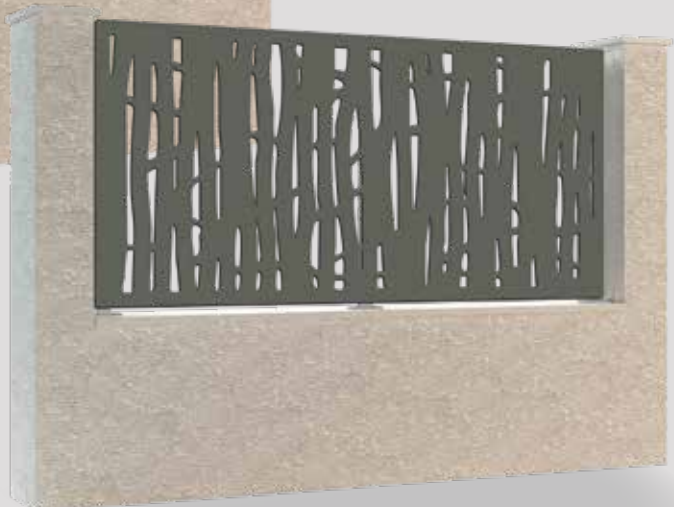

DESIGNER RAILING

Μοντέρνα σχέδια καγκέλων και αμέτρητοι συνδιασμοί με κατεργασίες ελασμάτων αλουμινίου πάχους 3 mm. Δυνατότητα πλάτους μέχρι 4 m και ύψους 2 m.

Modern railings designs and countless combinations with 3 mm thick aluminum sheet treatments. Possibility of width up to 4 m and height 2 m.

OPTION 1

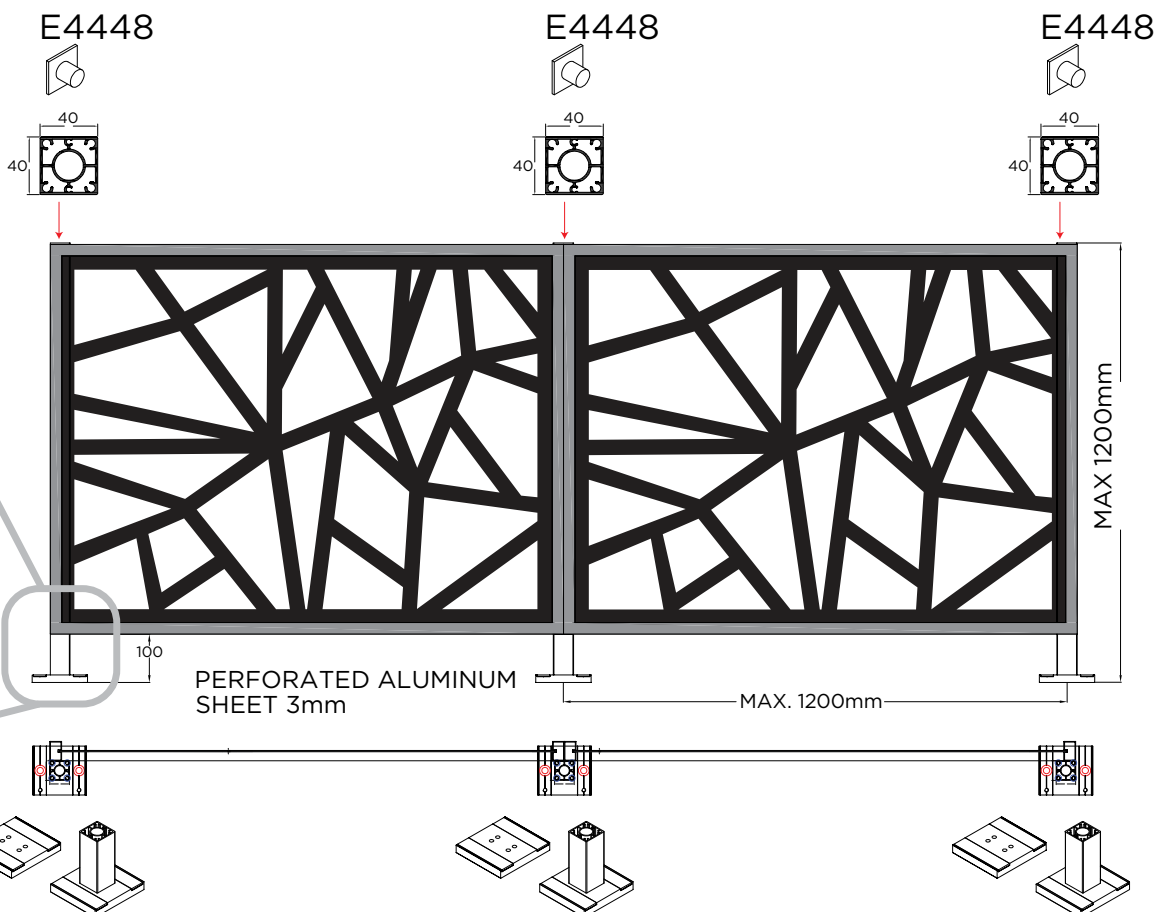

DESIGNER RAILING



OPTION 2

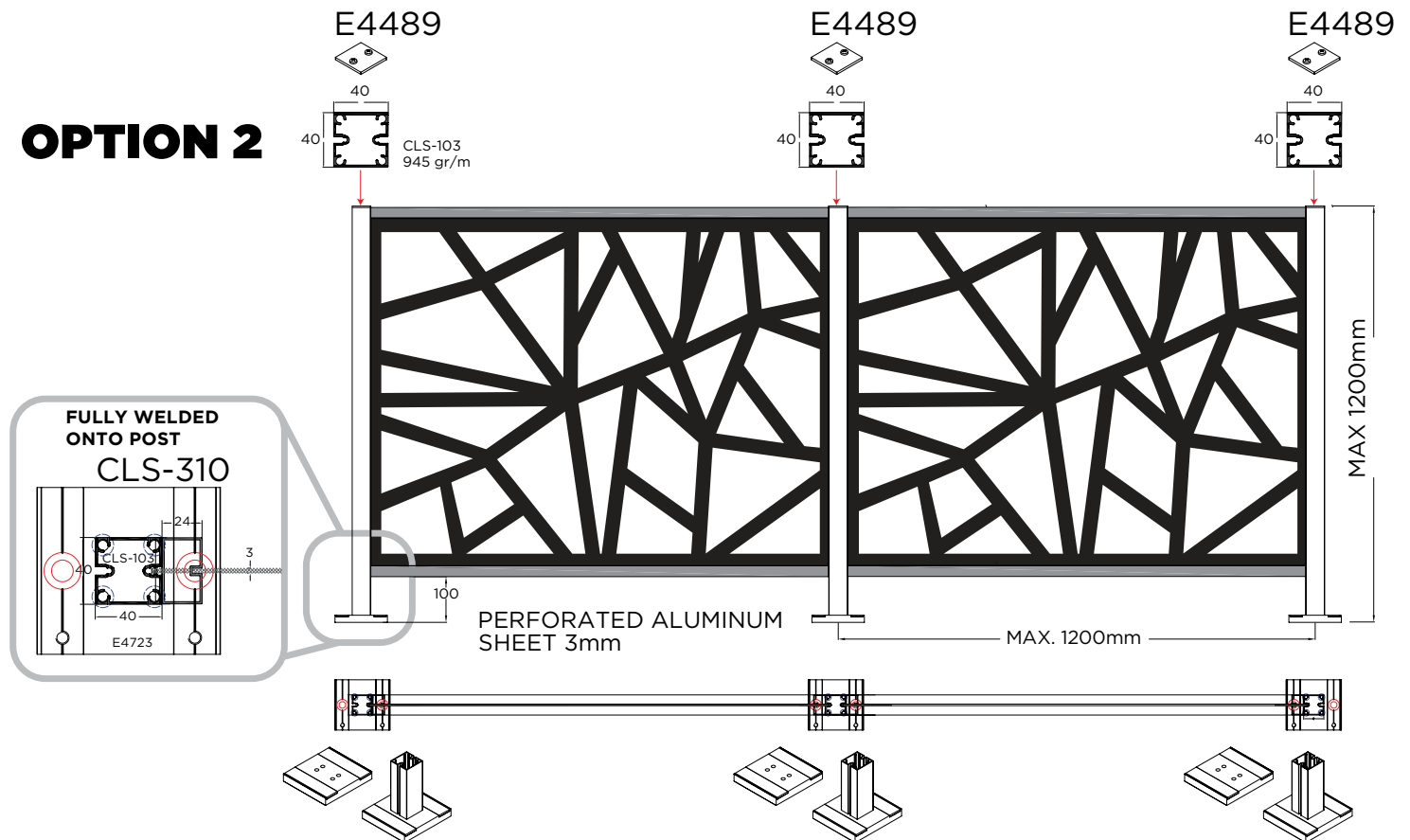

THE BLIND GATES & FENCES

Μοντέρνα σχέδια και αμέτρητοι συνδυασμοί καλύπτουν τις απαιτήσεις των σύγχρονων αρχιτεκτονικά κτιρίων. Αυλόπορτες από ραμποτέ προφίλ αλουμινίου σε κάθετη διάταξη που συνδυάζονται με ίnox στοιχεία, δημιουργούν ένα πραγματικό στολίδι στην είσοδο του σπιτιού σας.

BLIND GATE



THE BLIND GATES & FENCES

Modern designs and countless combinations meeting the needs of modern architectural buildings. Gates made of aluminium profiles in vertical lines combined with inox inserts, which makes them a true jewel placed at your house entrance.

BLIND FENCE



THE BLIND GATES & FENCES



THE BLIND GATES & FENCES

GV06



THE BLIND GATES & FENCES

FV01



FV02

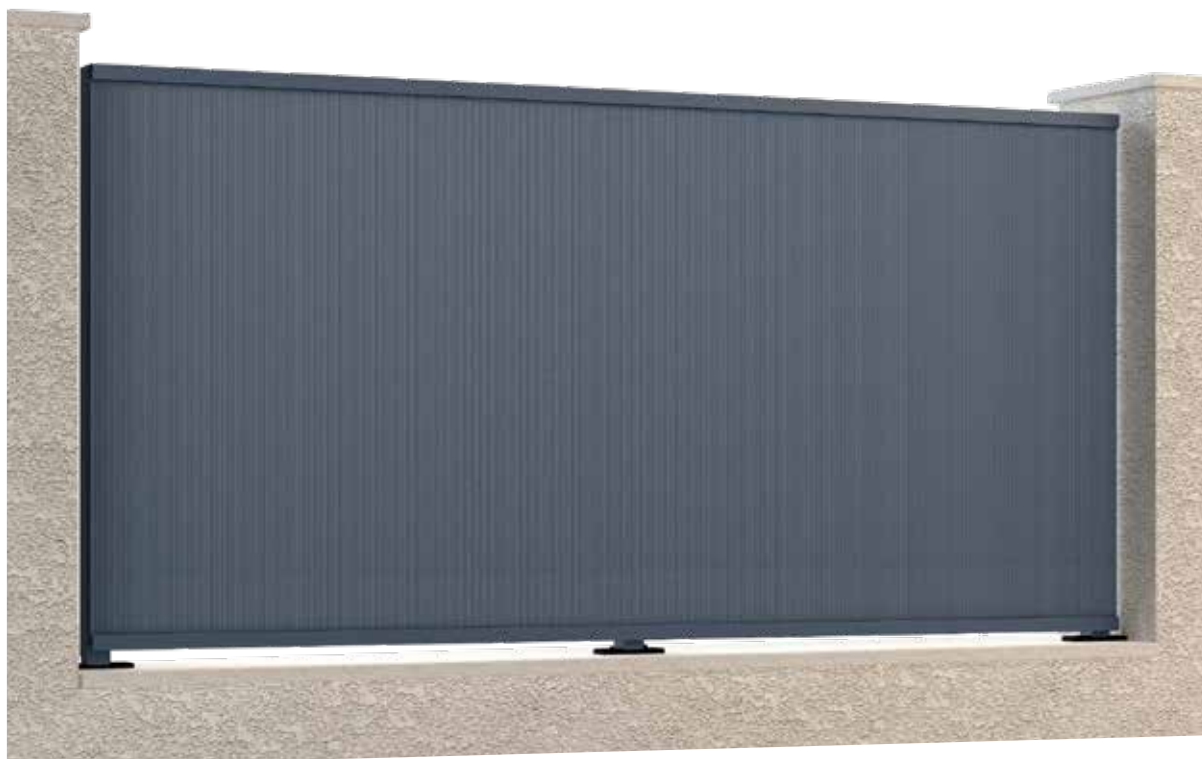

THE BLIND GATES & FENCES

FV70



FV06



THE BLIND GATES & FENCES

GV01



THE BLIND GATES & FENCES



THE BLIND GATES & FENCES

GH04



GH02



THE BLIND GATES & FENCES



THE BLIND GATES & FENCES



THE BLIND GATES & FENCES



FH10-04



GH02

THE BLIND GATES & FENCES



FH02



FH10-70

THE BLIND GATES & FENCES

GC06



THE BLIND GATES & FENCES

GC03



THE BLIND GATES & FENCES



THE BLIND GATES & FENCES

GC11



THE BLIND GATES & FENCES

GC12



THE FIN SERIES

Η σειρά FIN αποτελεί ένα σύστημα μοντέρνας περίφραξης από διαφορετικές περσίδες αλουμινίου, τοποθετημένες ένθετα, μεταξύ των κολόνων. Η επιπεδότητα των επιφανειών, η διατομή των περσίδων και τα μη εμφανή σημεία σύνδεσης προσφέρουν ένα minimal αποτέλεσμα με καθαρές λύσεις και ευθείες γραμμές, το οποίο μπορεί να καλύψει το σύνολο των τεχνικών και αισθητικών αναγκών ενός έργου.

An ultra-modern and minimal design for fences and dividing sections, The FIN Series fences feature a selection of vertical aluminium slats, mounted between posts totally mechanically without any visible screws or bolts. Protecting your home and privacy is no longer an issue! Suitable for commercial use as well due to the robustness and maintenance free quality.

THE FIN SERIES

FGC-201



FC-201



THE FIN SERIES

FC-202



THE FIN SERIES

FC-203



LINE GATE & FENCE



LINE GATE & FENCE

Δυνατότητα συρόμενης, ανοιγόμενης κατασκευής καθώς και αυλόγυρου.
Possibility of sliding or opening construction as well as a fence.

LINE GATE & FENCE



FC-204

ΠΡΟΦΙΛ / PROFILES

ΣΧΕΔΙΟ DESIGN	ΚΩΔΙΚΟΣ CODE	ΒΑΡΟΣ WEIGHT
	FSN-222	736 gr/m
	ΚΑΠΑΚΙ ΟΔΗΓΟΥ ΔΙΑΙΡΟΥΜΕΝΗ ΚΟΥΠΑΣΤΗ ΟΒΑΛ 90x30 COVER FOR GUIDE DIVIDED HANDRAILOVAL 90x30	
	CLS-201	757 gr/m
ΟΔΗΓΟΣ / GUIDE		
	FSN-221	754 gr/m
	ΚΑΠΑΚΙ ΟΔΗΓΟΥ ΔΙΑΙΡΟΥΜΕΝΗ ΚΟΥΠΑΣΤΗ 80x28 COVER FOR GUIDE DIVIDED HANDRAIL 80x28	
	CLS-201	757 gr/m
ΟΔΗΓΟΣ / GUIDE		
	CLS-3K1	450 gr/m
	ΚΑΠΑΚΙ ΟΔΗΓΟΥ ΔΙΑΙΡΟΥΜΕΝΗ ΚΟΥΠΑΣΤΗ CLS-301 COVER FOR GUIDE DIVIDED HANDRAIL CLS-301	
	CLS-301	588 gr/m
ΟΔΗΓΟΣ / GUIDE		
	CLS-308	528 gr/m
	ΟΔΗΓΟΣ AL-FLEX GUIDE FOR AL-FLEX	
	CLS-3K2	324 gr/m
	ΚΑΠΑΚΙ ΟΔΗΓΟΥ ΔΙΑΙΡΟΥΜΕΝΗ ΚΟΥΠΑΣΤΗ CLS-302 COVER FOR GUIDE DIVIDED HANDRAIL CLS-302	
	CLS-302	359 gr/m
ΟΔΗΓΟΣ / GUIDE		

ΣΧΕΔΙΟ DESIGN	ΚΩΔΙΚΟΣ CODE	ΒΑΡΟΣ WEIGHT
	CLS-303	348 gr/m
	ΟΔΗΓΟΣ / GUIDE	
	CLS-3K2	324 gr/m
ΚΑΠΑΚΙ ΟΔΗΓΟΥ ΔΙΑΙΡΟΥΜΕΝΗ ΚΟΥΠΑΣΤΗ CLS-302 COVER FOR GUIDE DIVIDED HANDRAIL CLS-302		
	CLS-202	1303 gr/m
	ΚΟΥΠΑΣΤΗ 80x28 HANDRAIL 80x28	
	CLS-307	262 gr/m
	ΟΔΗΓΟΣ AL-FLEX GUIDE FOR AL-FLEX	
	CLS-102	1245 gr/m
	ΚΟΛΩΝΑ 40x40 COLUMN 40x40	
	CLS-103	945 gr/m
	ΚΟΛΩΝΑ 40x40 ΜΕ ΥΠΟΔΟΧΗ ΓΙΑ ΒΙΔΑ COLUMN 40x40	
	CLS-104	945 gr/m
	ΚΟΛΩΝΑ 40x40 ΓΩΝΙΑ COLUMN 40x40 CORNER	

ΣΧΕΔΙΟ DESIGN	ΚΩΔΙΚΟΣ CODE	ΒΑΡΟΣ WEIGHT
	CLS-100	1606 gr/m
	ΚΟΛΩΝΑ 80x80 COLUMN 80x80	
	SH3200-601	502 gr/m
	ΕΣΩΤΕΡΙΚΟ ΠΡΟΦΙΛ INTERNAL PROFILE	
	CLS-304	389 gr/m
	ΕΣΩΤΕΡΙΚΟ ΠΡΟΦΙΛ INTERNAL PROFILE	
	FSN-302	781 gr/m
	ΕΣΩΤΕΡΙΚΟ ΠΡΟΦΙΛ INTERNAL PROFILE	
	FSN-304	804 gr/m
	ΕΣΩΤΕΡΙΚΟ ΠΡΟΦΙΛ INTERNAL PROFILE	
	WD-4024	336 gr/m
	ΤΡΑΒΕΡΣΑ TRAVERSE	
	WD-5001	187 gr/m
ΚΑΠΑΚΙ ΤΡΑΒΕΡΣΑΣ COVER FOR GUIDE		

ΣΧΕΔΙΟ DESIGN	ΚΩΔΙΚΟΣ CODE	ΒΑΡΟΣ WEIGHT
	SH3200-635	369 gr/m
	ΕΣΩΤΕΡΙΚΟ ΠΡΟΦΙΛ INTERNAL PROFILE	
	F50-106	794 gr/m
	ΕΣΩΤΕΡΙΚΟ ΠΡΟΦΙΛ INTERNAL PROFILE	
	822	629 gr/m
	ΚΟΛΩΝΑ COLUMN	
	CLS-309	477 gr/m
	ΟΔΗΓΟΣ ΨΑΘΑΣ PSATHA GUIDE	
	CLS-310	467gr/m
	ΟΔΗΓΟΣ ΔΙΑΤΡΗΤΗΣ ΛΑΜΑΡΙΝΑΣ GUIDE PERFORATED SHEET METAL	
	F50-115	2082gr/m
	ΚΟΛΩΝΑ 60x60 COLUMN 60x60	

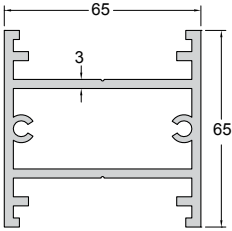
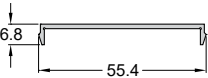
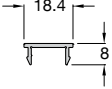
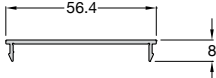
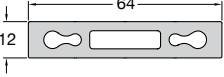
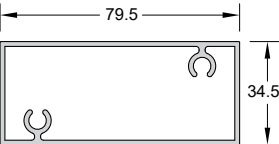
ΣΧΕΔΙΟ DESIGN	ΚΩΔΙΚΟΣ CODE	ΒΑΡΟΣ WEIGHT
	P2050-101	2376gr/m
	ΚΟΛΩΝΑ 65x65 COLUMN 65x65	
	P2050-1K2	257gr/m
	ΚΑΠΑΚΙ ΚΟΛΩΝΑΣ P2050-101 CUP FOR P2050-101 COLUMN	
	F50-135	120 gr/m
	ΚΑΠΑΚΙ ΚΟΛΩΝΑΣ F50-115 CUP FOR F50-115 COLUMN	
	F50-136	269 gr/m
	ΚΑΠΑΚΙ ΚΟΛΩΝΑΣ F50-115 CUP FOR F50-115 COLUMN	
	FSN-100	1442 gr/m
	ΚΟΛΩΝΑ COLUMN	
	FSN-401	1142 gr/m
	ΚΟΛΩΝΑ COLUMN	

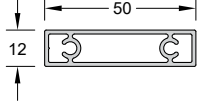
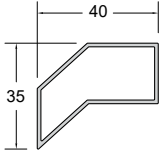
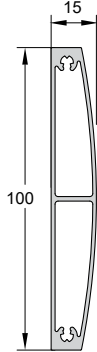
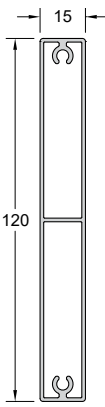
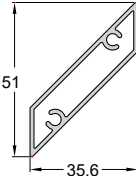
ΣΧΕΔΙΟ DESIGN	ΚΩΔΙΚΟΣ CODE	ΒΑΡΟΣ WEIGHT
	FSN-106	540 gr/m
	ΚΟΛΩΝΑ COLUMN	
	PF144-082	410 gr/m
	ΕΣΩΤΕΡΙΚΟ ΠΡΟΦΙΛ INTERNAL PROFILE	
	P070-002	958 gr/m
	ΕΣΩΤΕΡΙΚΟ ΠΡΟΦΙΛ INTERNAL PROFILE	
	P070-028	1019 gr/m
	ΕΣΩΤΕΡΙΚΟ ΠΡΟΦΙΛ INTERNAL PROFILE	
	SH3200-622	525 gr/m
	ΕΣΩΤΕΡΙΚΟ ΠΡΟΦΙΛ INTERNAL PROFILE	

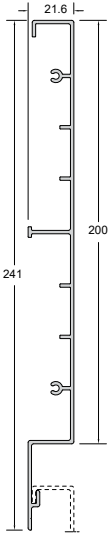
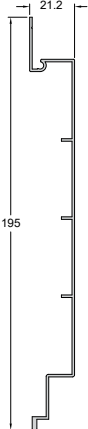
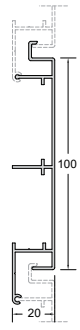
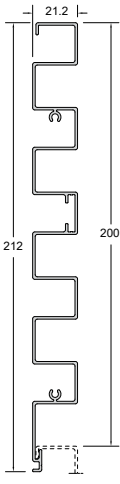
ΣΧΕΔΙΟ DESIGN	ΚΩΔΙΚΟΣ CODE	ΒΑΡΟΣ WEIGHT
	WD-2001	1597 gr/m
	ΠΡΟΦΙΛ W&D W&D PROFILE	
	P070-015	850 gr/m
	ΠΡΟΦΙΛ W&D W&D PROFILE	
	WD-2002	802 gr/m
	ΠΡΟΦΙΛ W&D W&D PROFILE	
	WD-2020	1479 gr/m
	ΠΡΟΦΙΛ W&D W&D PROFILE	

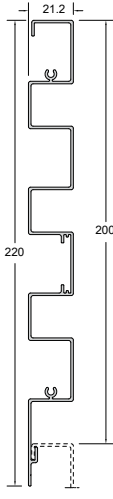
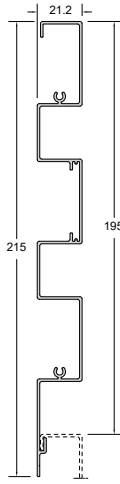
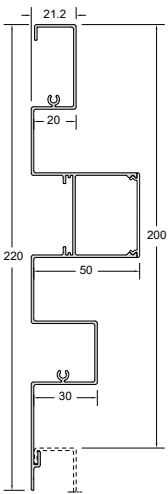









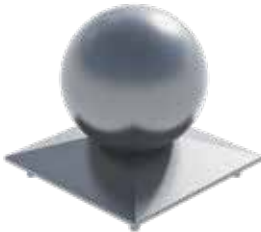

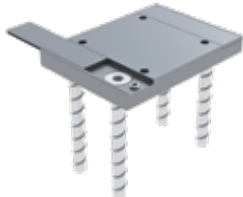
ΣΧΕΔΙΟ DESIGN	ΚΩΔΙΚΟΣ CODE	ΒΑΡΟΣ WEIGHT
	WD-2030	1382 gr/m
	ΠΡΟΦΙΛ W&D W&D PROFILE	
	WD-2040	1236 gr/m
	ΠΡΟΦΙΛ W&D W&D PROFILE	
	WD-2050	1523 gr/m
	ΠΡΟΦΙΛ W&D W&D PROFILE	

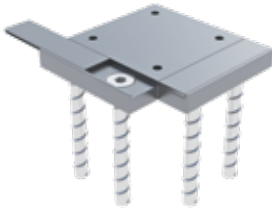
ΕΞΑΡΤΗΜΑΤΑ / ACCESSORIES

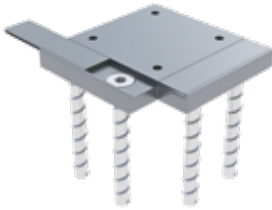
ΣΧΕΔΙΟ / DESIGN	ΚΩΔΙΚΟΣ / CODE
	22
	ΕΞΑΡΤΗΜΑ ΚΕΦΑΛΗΣ ALFLEX AL-FLEX CONNECTOR
	24
	ΕΞΑΡΤΗΜΑ ΚΕΦΑΛΗΣ ALFLEX AL-FLEX CONNECTOR
	E4176
	ΕΞΑΡΤΗΜΑ ΕΞΩΤΕΡΙΚΗΣ ΣΤΗΡΙΞΗΣ CLS-102 / 103 EXTERNAL FIXING COMPONENT FOR CLS-102 / 103
	4167
	ΕΝΔΟΔΑΠΕΔΙΟ ΣΤΗΡΙΓΜΑ ΓΙΑ ΚΟΛΩΝΑ F50-115 INFLOOR SUPPORT FOR COLUMN F50-115
	4188
	ΕΝΔΟΔΑΠΕΔΙΟ ΣΤΗΡΙΓΜΑ ΓΙΑ ΚΟΛΩΝΑ CLS-102 INFLOOR SUPPORT FOR COLUMN CLS-102

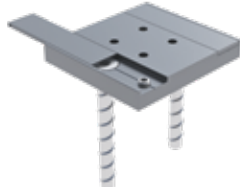
ΣΧΕΔΙΟ / DESIGN	ΚΩΔΙΚΟΣ / CODE
	E4270
	ΕΣΩΤΕΡΙΚΟΣ ΣΥΝΔΕΣΜΟΣ ΟΔΗΓΩΝ INTERNAL GUIDE CONNECTOR CLS-201_301_302_305
	E4271
	ΕΣΩΤΕΡΙΚΟΣ ΣΥΝΔΕΣΜΟΣ ΟΔΗΓΟΥ CLS-303 INTERNAL GUIDE CONNECTOR CLS-303
	E4261
	ΣΥΝΔΕΣΜΟΣ CLS-202 ΕΥΘΕΙΑ HORIZONTAL CONNECTOR CLS-202
	E4273
	ΣΤΑΘΕΡΟΣ ΓΩΝΙΑΚΟΣ ΣΥΝΔΕΣΜΟΣ ΚΟΥΠΑΣΤΗΣ CORNER JOINT FOR HANDRAIL CLS-202 / FSN- 221_CLS-201
	E4274
	ΣΤΗΡΙΓΜΑ ΓΙΑ ΕΞΩΤΕΡΙΚΗ ΨΑΘΑ EXTERNAL PSATHA SUPPORT
	E4275
	ΣΥΝΔΕΣΜΟΣ CLS-3K2_302 / CLS-201_FSN-221 ΕΥΘΕΙΑ CLS-3K2_302 / CLS- 201_FSN-221 HORIZONTAL CONNECTOR

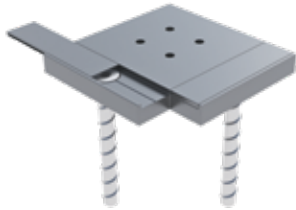
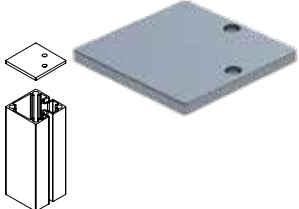
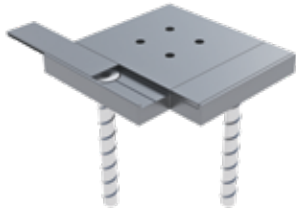
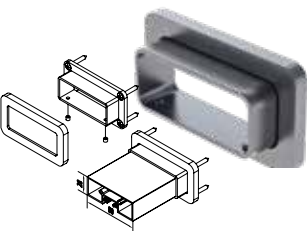
ΣΧΕΔΙΟ / DESIGN	ΚΩΔΙΚΟΣ / CODE	ΣΧΕΔΙΟ / DESIGN	ΚΩΔΙΚΟΣ / CODE
	E4278 ΣΥΝΔΕΣΜΟΣ CLS-3K2_303 ΕΥΘΕΙΑ CLS-3K2_303 HORIZONTAL CONNECTOR		E4376 ΕΝΔΙΑΜΕΣΗ ΑΡΘΡΩΣΗ ΟΔΗΓΟΥ ΣΕ ΣΚΑΛΑ STAIRS MIDDLE JOINT FOR GUIDE CLS-308
	E4282 ΣΥΝΔΕΣΜΟΣ CLS-102_σε τοιχο CLS-102_ CONNECTOR ONTO WALL		E4377 ΑΡΘΡΩΣΗ ΟΔΗΓΟΥ CLS-308 GUIDE CLS-308
	E4289 ΓΩΝΙΑΚΟΣ ΣΥΝΔΕΣΜΟΣ 90° ΓΙΑ ΚΟΥΠΑΣΤΗ CLS-201 CORNER CONNECTOR 90° FOR HANDRAIL CLS-201		E4378 ΑΡΘΡΩΣΗ ΚΟΥΠΑΣΤΗΣ FSN-221 / CLS-201 ΣΕ ΚΟΛΩΝΑ CLS-100 HANDRAIL FSN-221 / CLS- 201 JOINT FOR CLS-100
	E4290 ΕΞΩΤΕΡΙΚΟΣ ΣΥΝΔΕΣΜΟΣ ΟΔΗΓΟΥ CLS-309 & CLS-310 EXTERNAL GUIDE CONNECTOR CLS-309 & CLS-310		E4379 ΕΝΔΙΑΜΕΣΗ ΑΡΘΡΩΣΗ ΚΟΥΠΑΣΤΗΣ ΣΕ ΣΚΑΛΑ STAIRS MIDDLE JOINT FOR HANDRAIL FSN-221 / CLS-201
	E4345 ΣΤΗΡΙΓΜΑ ΚΟΥΠΑΣΤΗΣ CLS-202 HANDRAIL SUPPORT CLS-202		E4384 ΑΡΘΡΩΤΗ ΓΩΝΙΑ ΣΚΑΛΑΣ FSN-221_CLS-201 FLEXIBLE CORNER JOINT FOR STAIRS HANDRAIL CLS-202 / FSN-221_CLS-201
	E4375 ΜΥΛΟΣ ΚΟΥΠΑΣΤΗΣ ROTARY CONNECTOR		4410 ΚΑΠΑΚΙ ΠΡΟΦΙΛ 822 TOP COVER PROFILE 822

ΣΧΕΔΙΟ / DESIGN	ΚΩΔΙΚΟΣ / CODE	ΣΧΕΔΙΟ / DESIGN	ΚΩΔΙΚΟΣ / CODE
	E4448 ΤΑΠΑ ΚΟΛΩΝΑΣ F50-102, F50-109, CLS-102 END TAP FOR F50-102, F50-109, CLS-102		E4621 ΚΑΠΑΚΙ ΘΥΡΣΟΣ ΚΟΛΩΝΑΣ CLS-100 THIRSOS COVER FOR CLS-100
	E4482 ΤΑΠΑ ΚΟΛΩΝΑΣ F50-115 END TAP FOR F50-115		E4721 FOOTPLATE FOR 2 FIXING SCREWS FOR CLS-100
	E4485 ΚΩΝΙΚΗ ΤΑΠΑ ΚΟΛΩΝΑΣ CLS-100 CONICAL COVER FOR CLS-100		E4741 FOOTPLATE FOR 4 FIXING SCREWS FOR CLS-100
	E4486 ΙΣΙΑ ΤΑΠΑ ΚΟΛΩΝΑΣ CLS-100 FLAT COVER FOR CLS-100		E4722 FOOTPLATE FOR 2 FIXING SCREWS FOR CLS-100
	E4487 ΙΣΙΑ ΤΑΠΑ ΚΟΛΩΝΑΣ CLS-102 FLAT COVER FOR CLS-102		E4742 FOOTPLATE FOR 4 FIXING SCREWS FOR CLS-100
	E4489 ΙΣΙΑ ΤΑΠΑ ΚΟΛΩΝΑΣ CLS-103 FLAT COVER FOR CLS-103		E4723 FOOTPLATE FOR 2 FIXING SCREWS FOR CLS-102
	E4490 ΙΣΙΑ ΤΑΠΑ ΚΟΛΩΝΑΣ CLS-104 FLAT COVER FOR CLS-104		E4743 FOOTPLATE FOR 4 FIXING SCREWS FOR CLS-102
	4533Z ΑΡΜΟΚΑΛΥΠΤΡΟ ΚΟΥΠΑΣΤΗΣ CLS-201/2, FSN-221 (ΜΕ ΚΑΠΑΚΙ) WALL COVER FOR HANDRAIL CLS-201/2, FSN-221 (WITH CAP)		E4724 FOOTPLATE FOR 2 FIXING SCREWS FOR CLS-102
			E4744 FOOTPLATE FOR 4 FIXING SCREWS FOR CLS-102
			E4921 ΤΑΠΑ ΓΙΑ FSN-222/CLS-201 COVER FOR FSN-222/CLS-201

ΣΧΕΔΙΟ / DESIGN	ΚΩΔΙΚΟΣ / CODE
	<p data-bbox="571 192 655 220">E4922</p> <p data-bbox="459 290 767 347">ΤΑΠΑ ΓΙΑ FSN-221/CLS-201 COVER FOR FSN-221/CLS-201</p>
	<p data-bbox="571 417 655 445">E4491</p> <p data-bbox="499 515 730 572">ΤΑΠΑ ΓΙΑ CLS-202 COVER FOR CLS-202</p>
	<p data-bbox="571 663 655 692">E4954</p> <p data-bbox="512 784 715 884">ΛΟΞΗ ΤΑΠΑ 45° ΓΙΑ ΤΟ FSN-401 SLOPE COVER 45° FOR FSN-401</p>
	<p data-bbox="571 980 655 1009">E4952</p> <p data-bbox="491 1100 735 1201">ΓΩΝΙΑΚΗΣ ΔΙΑΤΑΞΗΣ ΤΑΠΑ ΓΙΑ ΤΟ FSN-401 ANGULAR COVERS FOR FSN-401</p>
	<p data-bbox="571 1299 655 1327">E4953</p> <p data-bbox="467 1417 759 1517">ΕΥΘΥΓΡΑΜΜΗΣ ΔΙΑΤΑΞΗΣ ΤΑΠΑ ΓΙΑ ΤΟ FSN-401 LINEAR COVER FOR FSN-401</p>
	<p data-bbox="571 1613 655 1642">E4534</p> <p data-bbox="467 1712 759 1790">ΚΑΠΑΚΙ ΚΟΛΩΝΑΣ F50-115 TOP COVER FOR POST F50-115</p>
	<p data-bbox="571 1876 655 1904">E4124</p> <p data-bbox="459 1967 767 2068">ΠΕΛΜΑ ΣΤΗΡΙΞΗΣ ΓΙΑ ΚΟΛΩΝΑ 40x40 SUPPORT FOOT FOR 40x40 COLUMN</p>



ALUMINCO[®]
ALUMINIUM BUILDING SYSTEMS

Aluminium Building Systems Industry
320 11 Inofita Viotia - Greece
T: +30 22620 47000
F: +30 22620 47090
E: info@aluminco.com
www.aluminco.com

Βιομηχανία Συστημάτων Αλουμινίου
320 11 Οινόφυτα Βοιωτίας
T: 22620 47000
F: 22620 47090
E: info@aluminco.com
www.aluminco.com

Version 02/2025

This catalogue supersedes all previous ones